



ART NOVA



ART NOVA



Nuvole di soffici materiali vi accolgono: la sartorialità si fonde con design e tecnologia. Volumi e superfici raccontano nuovi modi di vivere i divani ed inedite declinazioni del comfort: i prodotti si trasformano, gli schienali si muovono, si adattano, facendo intuire e scoprire inaspettati livelli di comodità e versatilità.

Esclusive esperienze tessili, soffici fibre e innovative schiume si miscelano insieme per concedere piacevoli ed inaspettate sensazioni ogni volta si provi un divano Art Nova.

Nuove forme e moduli si affiancano, giocano tra loro, creando inedite libertà di abitare e intuire gli spazi, contemporanee ed eleganti linee estetiche.

Materia, passione e design.

Soft clouds of materials embrace you: craftsmanship blends with design and technology. Volumes and surfaces tell a story about new ways of experiencing comfort: products are transformed; backrests move and adapt allowing you to discover new and unexpected comfort and versatility levels.

Unique textiles experiences, soft fibres and innovative foams are mixed together: pleasant and unexpected feelings for you, every time you sit on a Art Nova sofa.

New forms and modules get together; they play with each other, creating new and free ways of interpreting the living spaces, generating elegant and aesthetic lines.

Matter, passion and design.



ART NOVA
Designed in Italy
Made in Italy

<i>06</i>	BYRON
<i>28</i>	COSY
<i>42</i>	FLARE Tables
<i>49</i>	GLAM
<i>68</i>	GLAM Tables
<i>77</i>	FILIPH AIR
<i>98</i>	FILIPH Tables
<i>102</i>	DYNAMIC
<i>114</i>	CLOUD
<i>118</i>	CLOUD Tables
<i>126</i>	CLOUD Limited Edition
<i>135</i>	FILIPH
<i>164</i>	FILIPH OUTDOOR
<i>171</i>	OLTRE
<i>181</i>	SQUARE LINE
<i>197</i>	BLUM
<i>208</i>	WILL
<i>220</i>	SHABBY
<i>226</i>	HELEN
<i>234</i>	CELINE
<i>242</i>	TULIP
<i>247</i>	LOVE CHAIR
<i>253</i>	GENTLEMAN
<i>259</i>	INDY
<i>263</i>	INDY TAILOR
<i>271</i>	ISLAND BED
<i>275</i>	BOLD
<i>279</i>	INFO AND SIZE

BYRON

Un sofisticato gioco fra la struttura leggera ed elegante e il richiamo rassicurante dei rulli, in preziosi materiali, caratterizza l'anima innovativa del progetto Byron.

Armonia delle linee e rigore formale si declinano in un sistema di sedute con una forte personalità sartoriale.

A sophisticated play between the light and elegant structure and the reassuring call of the rolls, in exquisite materials, characterises the innovative soul of the Byron project.

Harmonious lines and formal rigour converge to form a seating system with a strong sartorial personality.





L'estetica pulita e sofisticata nasconde materiali innovativi e tradizionali che si miscelano sapientemente per un risultato di grande comfort. La seduta invitante, le cuscinerie ergonomiche e le diverse possibilità di profondità (92 e 102 cm) permettono di progettare un divano adatto a ogni esigenza di relax od ospitalità.



The clean-cut and sophisticated aesthetics hide innovative and traditional materials which are skilfully blended to generate supreme comfort. The inviting seat, the ergonomic cushions and different depth options (92 and 102 cm) enable the creation of a sofa suitable for all relaxation or hospitality requirements.





La combinazione di braccioli convenzionali o a rulli mobili spezza lo schema compositivo creando uno stile dinamico e altamente progettuale: insieme al bouquet di materiali e texture in collezione, da vita a molteplici accostamenti creativi.

Insoliti accostamenti che, mitigati dal carattere armonico di Byron, raccontano sempre un gusto equilibrato e raffinato.

The combination of conventional arm rests or mobile rolls breaks the composition down, creating a dynamic and highly project-oriented style. The bouquet of materials and textures featured in the collection brings to life a multitude of creative blends. Unusual blends, mitigated by the harmonious character of Byron, which always exude well-balanced and refined tastefulness.

L'universo di accessori e complementi che ruota attorno a Byron ne esalta la duttilità compositiva ed espressiva. Il gioco dei tavolini in sovrapposizione e i richiami materici e cromatici definiscono uno stile dello spazio living affascinante e personale.

The universe of accessories and complementary items which gravitates around Byron exalts its compositional ductility and expressiveness.

The play of overlapping side tables, recurring materials and colours defines a captivating and personal style for living interiors.





Il sistema di seduta Byron è disponibile in due profondità (92 e 102 cm) che possono essere accostate in soluzioni compositive originali ed individuali.

The Byron seating system is available in two depths (92 and 102 cm) which can be arranged into original and individual layouts.





Bespoke *finishes*



Basamento e piedini finitura Peltro.
Struttura bracciolo rivestita in Nabuk.
Rullo in Nabuk.

*Pewter finish base and feet.
Arm rest structure and roll covered in Nabuk.*



Basamento e piedini in alluminio spazzolato lucido.
Struttura bracciolo rivestita in Tecnonabuk imprimée.
Rullo in Tecnonabuk.

*Shiny brushed aluminium base and feet.
Arm rest structure and roll covered in Tecnonabuk.*



Basamento rivestito in pelle.
Piedini angolari finitura Nichel nero.
Struttura bracciolo rivestita in Nabuk. Rullo in pelle.

*Leather-covered base.
Corner feet with black Nickel finish.
Arm rest structure covered in Nabuk. Leather roll.*

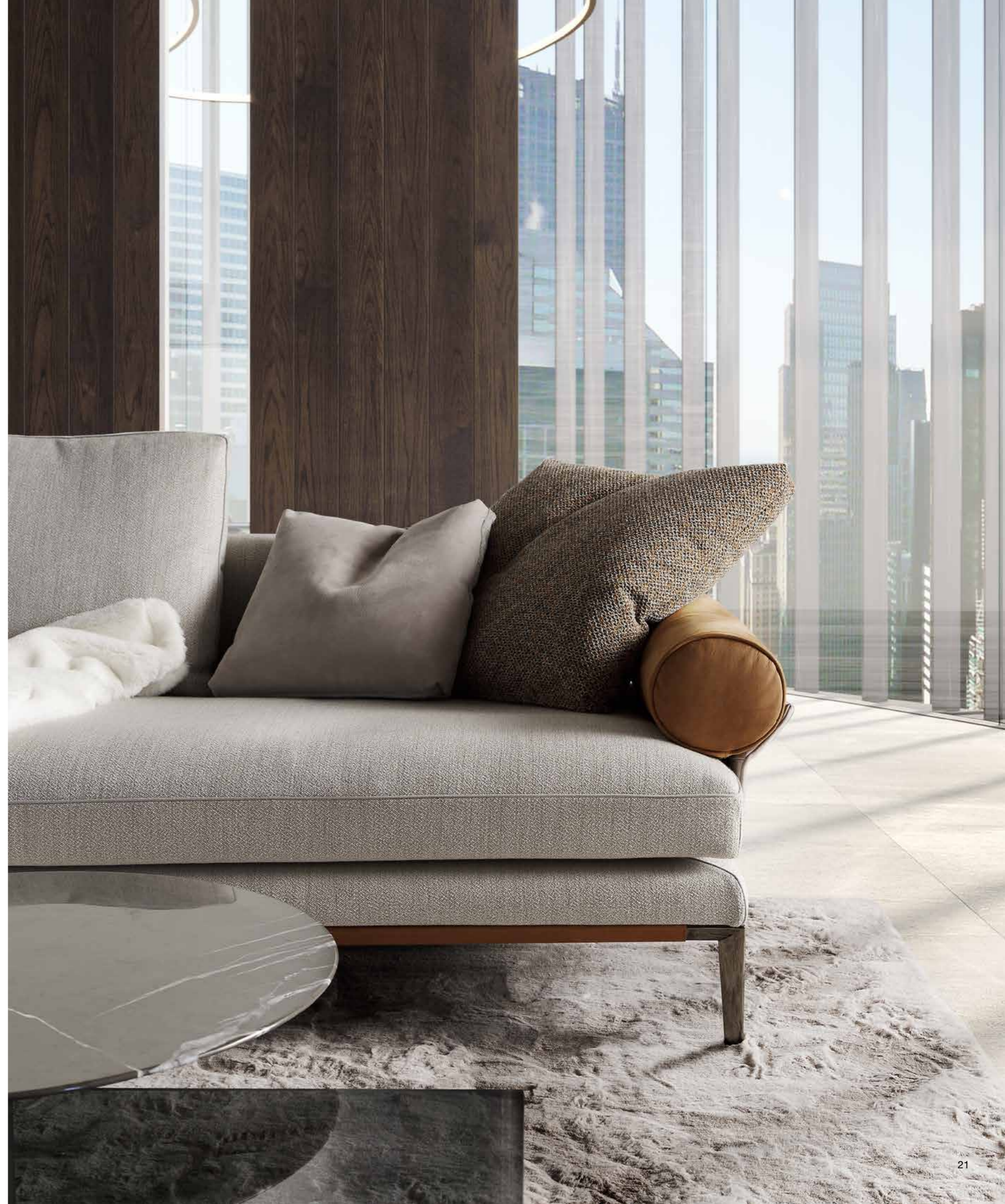



A game of design *and fine tailoring*

La combinazione di tecnologia e savoir-faire crea oggetti unici e ricchi di fascino.

Le decise e sottili linee del basamento in alluminio corrono lungo Byron dialogando con finiture esclusive di pellami e tessuti: le cuciture a profilo disegnano i precisi volumi e raccontano grande ricerca sartoriale.



The combination of technology and savoir-faire creates unique objects, rich in allure. The decisive and slender lines of the aluminium base run along Byron, engaging in dialogue with exclusive leather and fabric finishes: piping stitching draws precise volumes and expresses fine tailoring.

Sofisticata *ergonomia*



La leggerezza visiva e le dimensioni contenute lasciano spazio in maniera inaspettata ad ergonomiche ed accoglienti cuscinerie poggiatesta. Insieme alle diverse profondità di seduta ed ai braccioli a rullo spostabili, il progetto Byron si trasforma in un vero laboratorio su misura.

The visual lightness and compact size leave space for inviting ergonomic cushions with headrests. Combined with different seating depths and movable armrest rolls, the Byron project transforms into a veritable tailored workshop.





COSY

Il sistema divani Cosy reinterpreta suggestioni e linee vintage in chiave contemporanea e innovativa.

Il sapiente disegno di curve e imbottiture crea un gioco di volumi inediti e affascinanti.

Un'estetica che racconta morbidezza e accoglienza, tradizione e innovazione.

The Cosy sofa system is a contemporary and innovative retake of vintage suggestions and lines.

The skilful design of curves and upholstery creates an original and fascinating play on volumes.

Aesthetics speak of softness, hospitality, tradition and innovation.







Schienali e braccioli piegano dolcemente e si arricchiscono di sartorialità: pinces e un originale taglio longitudinale esaltano le curve e donano un aspetto distintivo e iconico al prodotto. Sedute monoblocco, lunghe e sollevate da terra, donano leggerezza e stabilità al contempo. Soffici cuscini in Hi-tex completano un comfort che seduce immediatamente.

Backs and arm rests curve softly and are sartorially enriched. Pleats and an original longitudinal layout exalt curves, conferring a distinctive and iconic appearance upon the product. Single-block seating, long and suspended above the ground, effortlessly combine lightness and stability. Soft Hi-tex cushions complete a type of comfort which immediately wins the user over.





L'estetica elegante e accogliente è caratterizzata da volumi morbidi e generosi che trovano ordine nella finitura sartoriale a profilo che delinea ed esalta le forme. Giochi d'abbinamento tra tessuti e pellami descrivono una cifra stilistica raffinata e riconoscibile.

Elegant and welcoming aesthetics are characterised by soft and generous volumes, exalted by sartorial piping which outlines and enhances shapes. Plays on fabric and leather combinations describe refined and distinctive keynotes.



Modular & taylor

Cosy rappresenta un vero e proprio sistema di elementi modulari che grazie a 5 basi, 2 elementi schienali e 1 elemento bracciolo consente infinite varianti di divani e configurazioni. I layout progettati, chiusi o aperti, sono modificabili e invertibili a piacimento nel tempo. Le sedute sono dotate di un originale sistema a binario che consente il fissaggio di braccioli e schienali in ogni punto della base.

Cosy is a veritable system of modular elements which thanks to 5 bases, 2 backs and 1 arm rest enables infinite versions of sofas and configurations. Designed layouts, closed or open, can be changed and inverted on a whim over time. Seating is fitted with an original track system which enables the attachment of arm rests and backs to any point of the base.



Esempio di configurazioni che cambiano variando posizione agli stessi elementi modulari. L'operazione di modifica del layout avviene attraverso lo smontaggio e il rimontaggio di schienali e braccioli in differenti posizioni.

Example of configurations which change by switching the position of modular elements.

The layout change operation takes place by disassembling and re-assembling backs and arm rests in different positions.

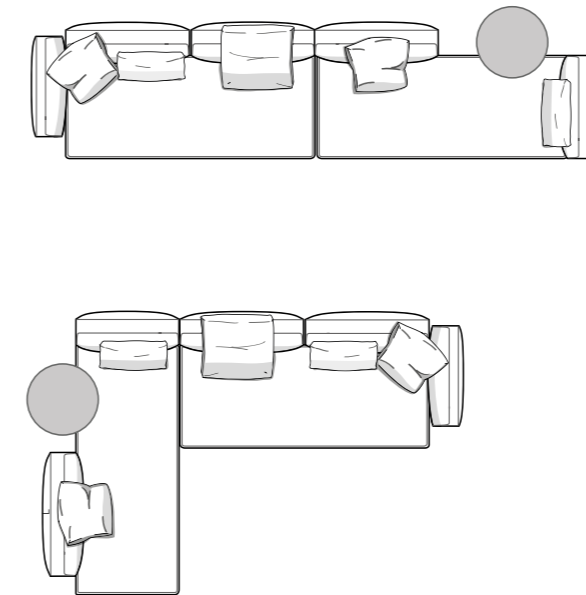



FLARE *tables*

Una collezione di tavolini in varie altezze e misure di piano dal design originale e attrattivo che richiama in chiave contemporanea lo schema dei classici treppiedi francesi del XVII secolo. Le gambe leggere, eleganti e dal tratto dinamico si piegano dolcemente e si allungano fino a sostenere piani tondi da 52, 60 e 80 cm di diametro, in tre altezze da terra, 41, 49 e 61 cm, per assecondare diverse funzionalità.

Tre finiture del basamento in pressofusione d'alluminio e 9 diverse varianti di materiali per il piano creano affascinanti combinazioni.

A collection of occasional tables of various heights and top sizes featuring an original and captivating design, conceived as a contemporary retake of classic 17th century French three-legged side tables.

The light, elegant and dynamic legs softly fold and extend and can support 52, 60 and 80 cm round tops at three different heights, 41, 49 and 61 cm from the ground, designed for different functionalities. The die-cast aluminium base is available in three finishings, along with 9 different material versions for the top, enabling nothing short of exquisite combinations.



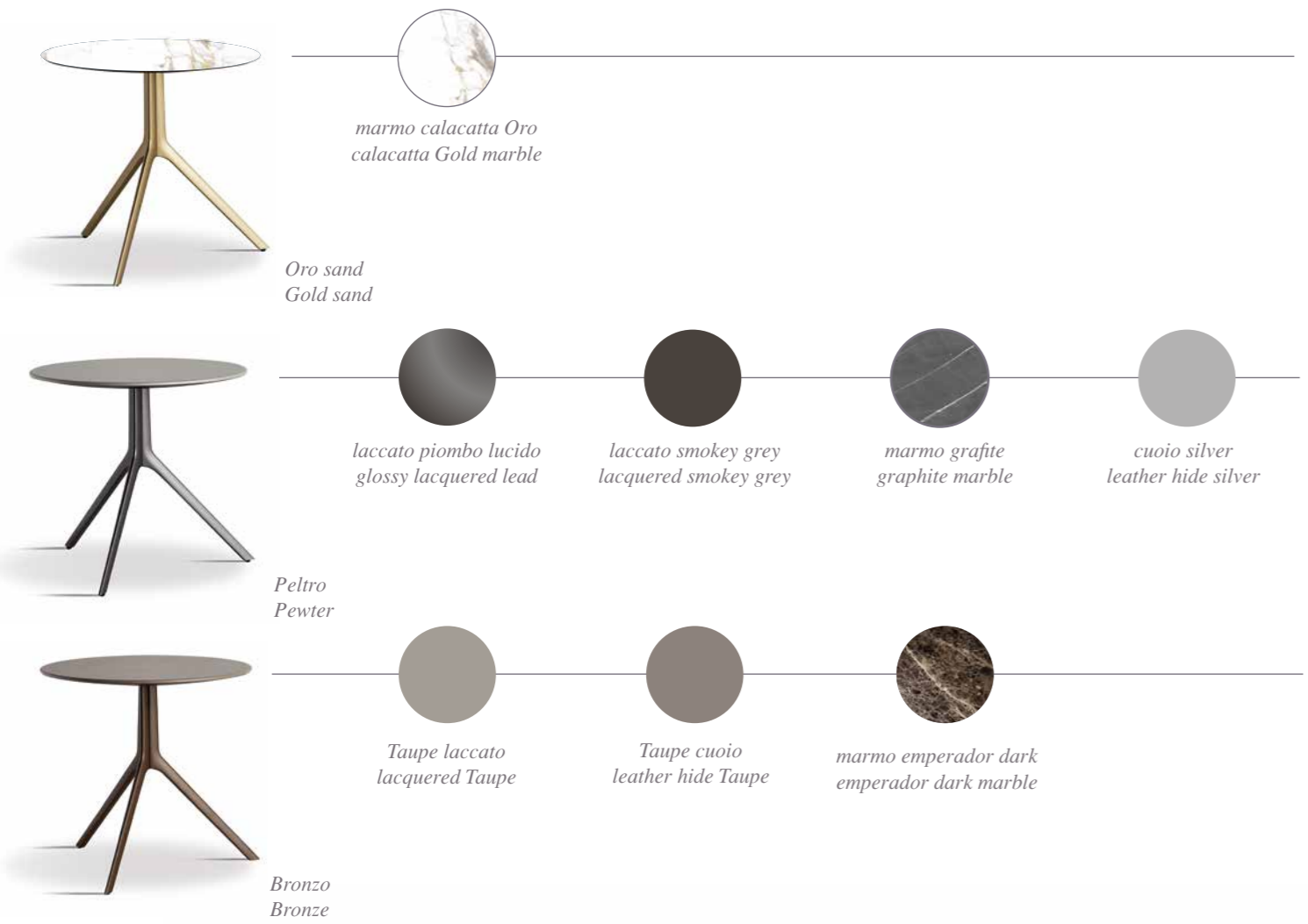

FR52
Tavolino rotondo 52 cm H49 cm
Side table 52 cm H49 cm

FR60
Tavolino rotondo 60 cm H61 cm
Side table 60 cm H61 cm





FR80 MGP

Tavolino rotondo da 80cm, H 41cm
Basamento Peltro, piano in marmo Grafite

*Round small table 80cm, H 41 cm
Pewter base, Grafite marble top*

FR130G

Tavolino da 130x65cm, H 36cm
Basamento Peltro, piano vetro fumè

*Small table 130x65 cm, H 36cm
Base Pewter, smoked glass top.*





GLAM

Design contemporaneo e originali accostamenti definiscono la collezione GLAM.

Un sistema di sedute differenziate, schienali mobili e complementi in legno e metallo si compongono e affiancano creando innovative combinazioni e layout. Raffinati dettagli e finiture raccontano l'eleganza senza tempo di un progetto sofisticato.

Contemporary design and original combinations define the GLAM collection. A differentiated seating system, mobile back rests, accessories in wood and metal are composed and matched to create innovative combinations and layouts. Refined details and finishing exude timeless elegance in this sophisticated project.







merge *LINE and* CURVES



Le linee tese dei profili in gros grain definiscono e addomesticano le curve generose e avvolgenti della struttura. Linee curve e cuscinate si affiancano e convergono con naturalezza disegnando un gusto equilibrato e contemporaneo.

The tense lines of gros grain profiles define and tame the structure's generous and enveloping curves. Curved lines and cushioning are matched and seamlessly blend to create a balanced and contemporary flavour.

Sand gray *ice blue nuances*

Sfumature di grigio e sabbia giocano tra loro creando calde e raffinate texture senza tempo.

Bagliori di ghiaccio e azzurro illuminano morbidi colori in un abbinamento contemporaneo e universale.

Ricami tridimensionali esaltano la ricchezza della materia.

Shades of grey and sand play to create warm, refined and timeless textures. Flashes of ice and blue illuminate soft colours, in a contemporary and universal combination. Three-dimensional embroidery exalts the richness of material.

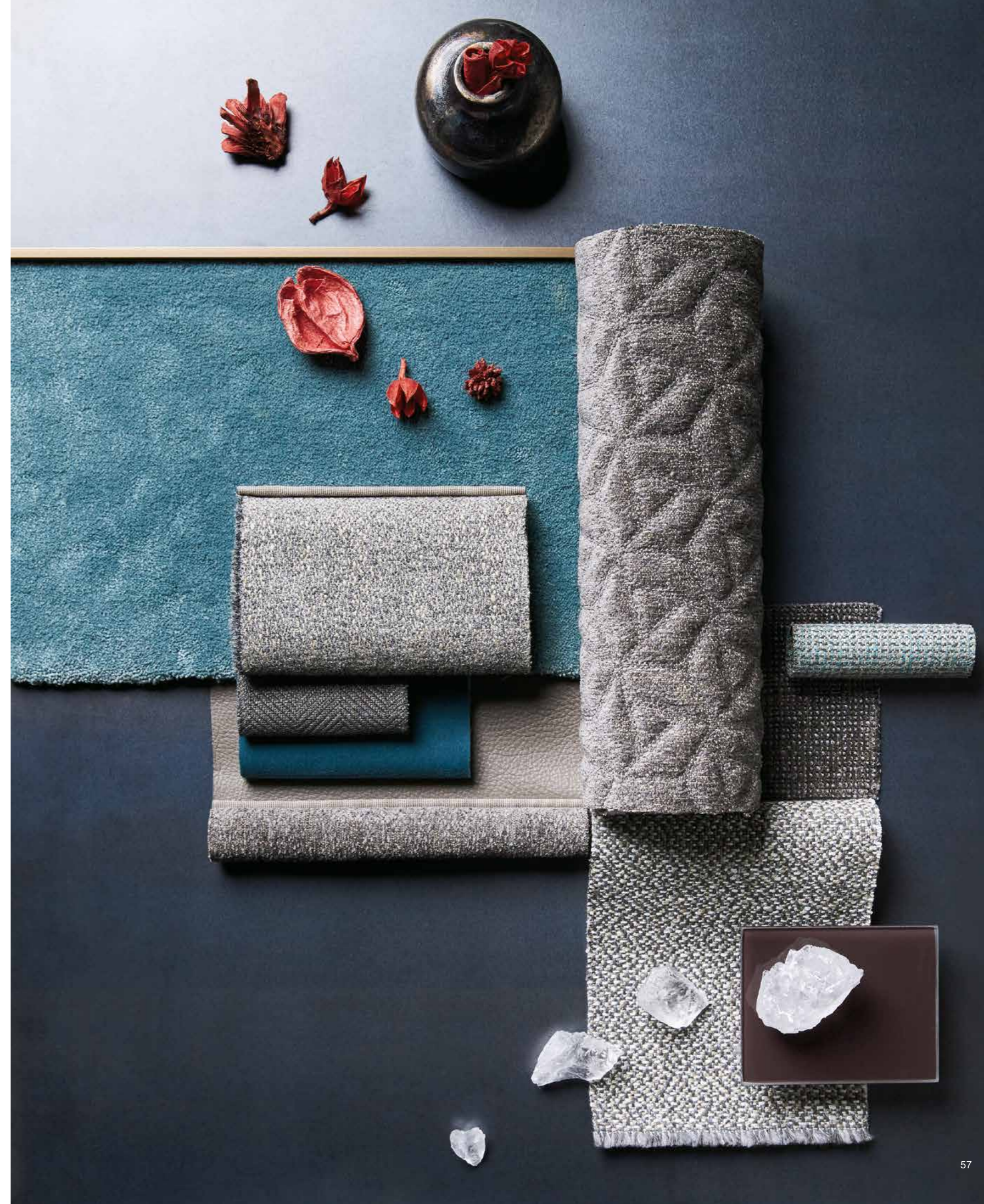

GLAM SEATING *system*

Un sistema di sedute ed elementi duttile e originale permette di creare configurazioni dalle tradizionali alle più innovative con estrema versatilità. Interpretare la zona living con nuove idee di composizione arricchisce gli spazi domestici di una nuova e funzionale eleganza. Creatività e razionalità possono coesistere.

A seating system featuring original and ductile elements, enabling the creation of configurations ranging from traditional to innovative, with extreme versatility. Interpreting the living room area with new composition ideas enriches home interiors with a new and functional elegance. Creativity and rationality can co-exist.





Divani convenzionali con cuscino di seduta si affiancano a sofisticati elementi terminali con basi a monoblocco creando raffinati e inaspettati accostamenti. Tavolini, accessori e schienali mobili si alternano fra gli elementi completando un sistema ricco di spunti estetici e funzionali.

Conventional sofas with seat cushion are matched with sophisticated end elements, with single block element bases which create refined and original combinations. Side tables, accessories and movable backrests alternate between elements, completing a system rich in aesthetic and functional inspiration.









COFFEE and *Glam* SIDE-TABLES

Elementi materici dalle forme essenziali sapientemente proporzionati e posizionati creano oggetti preziosi e ricercati.

La purezza delle linee e la qualità della materia arricchisce una collezione di tavolini senza tempo.

Material elements with wisely proportioned and positioned essential shapes create precious and refined objects. The purity of the lines and the quality of the material enriches a collection of timeless tables.



GLT40 MEB
emperador dark marble + bronze



GLT40 MGP
graphite marble + pewter



GLT40 LYP
smokey grey + pewter



GLT40 WSB
spessart oak + bronze

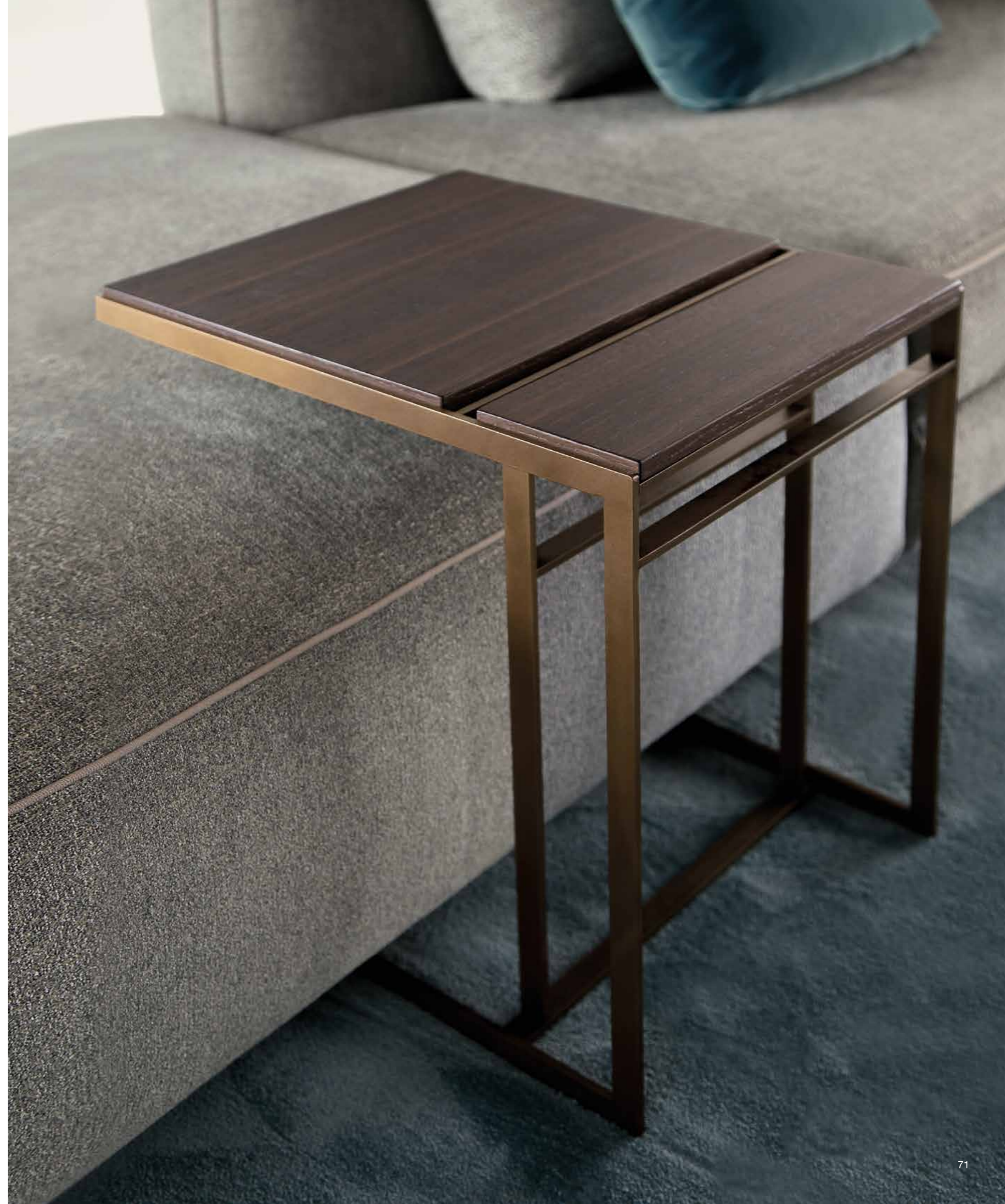

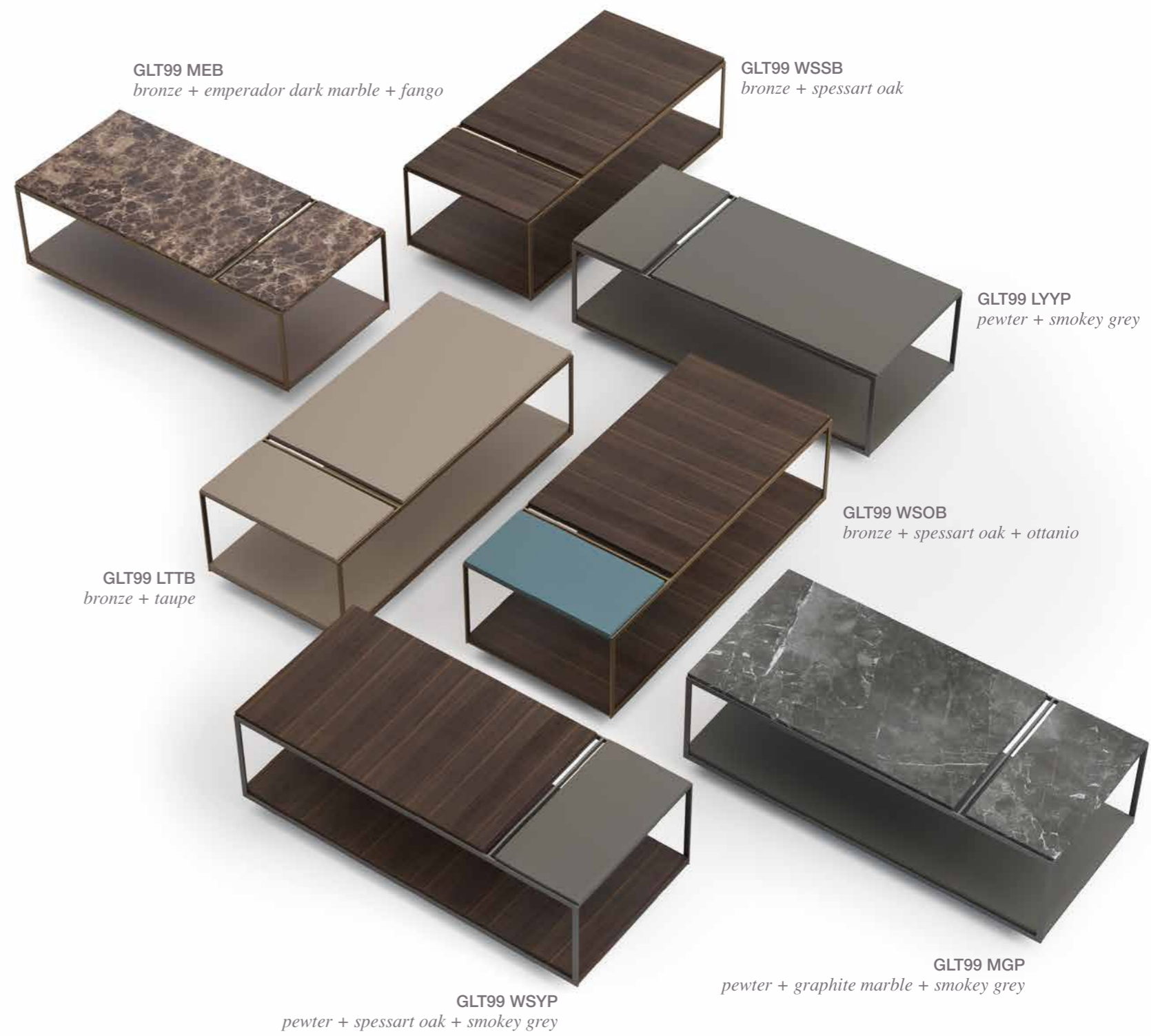

GLT99 MEB
bronze + emperador dark marble + fango

GLT99 WSSB
bronze + spessart oak

GLT99 LYYP
pewter + smokey grey

GLT99 LTTB
bronze + taupe

GLT99 WSOB
bronze + spessart oak + ottanio

GLT99 WSYP
pewter + spessart oak + smokey grey

GLT99 MGP
pewter + graphite marble + smokey grey



GLT52 CGB
bronze + leather hide graphite

Il fascino del cerchio e la seduzione di marmo e cuoio donano carattere alla collezione di tavolini Glam. Diverse misure in un gioco di proporzioni consentono eleganti combinazioni di volumi e materia.

The charm of the circle and the marble seduction and leather add character to the Glam coffee tables collection. Several measures in a game of proportions allow elegant combination of volumes and materials.



GLT68 CSP
pewter + leather hide silver

GLT68 LYP
pewter + smokey grey lacquered

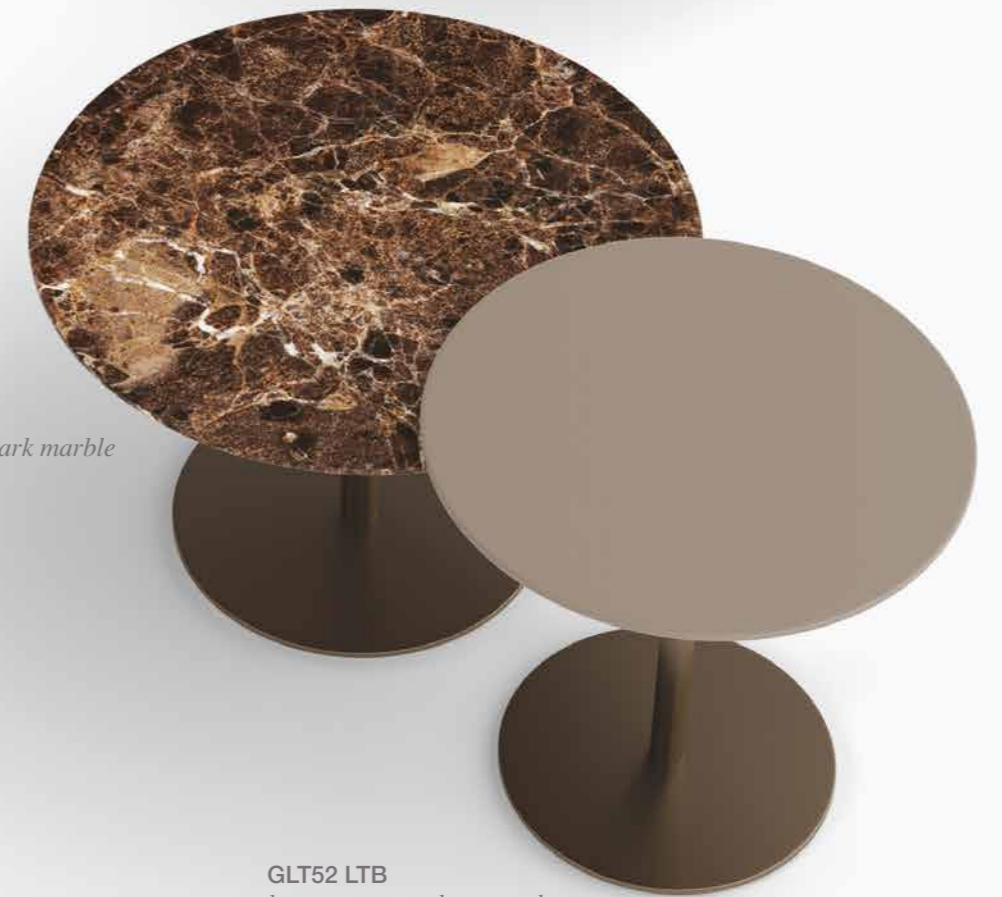

GLT68 MEB
bronze + emperador dark marble

GLT52 LTB
bronze + taupe lacquered



FILIPH AIR

L'evoluzione del sistema FILIPH interpreta diversi gusti estetici arricchendosi di una nuova versione caratterizzata da grande leggerezza ed equilibrio formale. Gli schienali si muovono a piacimento sulla grande isola di seduta dall'aspetto sospeso che si trasforma, adattandosi allo spazio ed al comfort personale, da divano raccolto a grande chaise-longue bifacciale.

The evolution of the FILIPH system interprets different aesthetic tastes, enriched by a new version characterised by supreme lightness and formal balance. Backs can be conveniently moved along the large island which appears suspended and transforms to adapt to interiors and personal comfort requirements, from a compact sofa into a double-faced chaise longue.



reddot design award
winner 2018



Suspended *Leggerezza ed eleganza nel look sospeso* look

I grandi piani di seduta, disponibili in diverse profondità, appaiono sospesi ed aerei, grazie all'originale design di basamenti a slitta progettati per sfumare e nascondersi alla vista da molte angolazioni. Innovativi materiali di seduta (MEMOSOFF) completano l'aspetto composto della base, donando morbidezza, comfort e ordine al contempo.

Spacious seats, available in a variety of depths, appear suspended and airy, thanks to the original glide base designed to blend and remain hidden from most angles. Innovative seating materials (MEMOSOFF) complete the base's look, conferring softness, comfort and order.





NEW DYNAMIC *Shapes*

Nuove forme a trapezio delle basi si affiancano tra loro e creano spazi dinamici e funzionali.

Le basi sono simmetriche, invertibili e possono essere accostate anche ad elementi lineari.

Un nuovo schienale mobile piegato accoglie due persone e crea un piacevole gioco di volumi con le basi.

New trapezoid shapes of the bases are placed side by side and create dynamic and functional spaces.

The bases are symmetrical, invertible and can also be combined with linear elements.

A new movable backrest folded and can accommodate two people and creates a nice game of volumes with the bases.





LIGHTS *side-tables*

I tavolini Filiph luminosi disegnano i tessuti esaltando colori e texture. Un sistema a Led nascosto crea nuove atmosfere e inaspettate scenografie di luce.

The luminous Filiph tables draw the tissues, enhancing colors and textures. A hidden Led system creates new and unexpected atmospheres of light scenes.



Shades of Petra

between sky and earth

Polvere di cipria accarezza pregiati filati bouclé dai toni del cielo e del mare. Sfumature della sabbia di Petra donano a tessuti e pellami un tono delicato che esalta l'eleganza dell'abitare. Azzurri e ottanio, densi e luminosi, contrastano di luce i colori della terra.

Pink powder softly caresses exquisite bouclé yarns in sky and sea blue tonalities. Shades of Petra sand confer a delicate tonality upon fabrics and leather, exalting the elegance of living interiors. Dense and luminous blues and teals contrast earth colours with light.

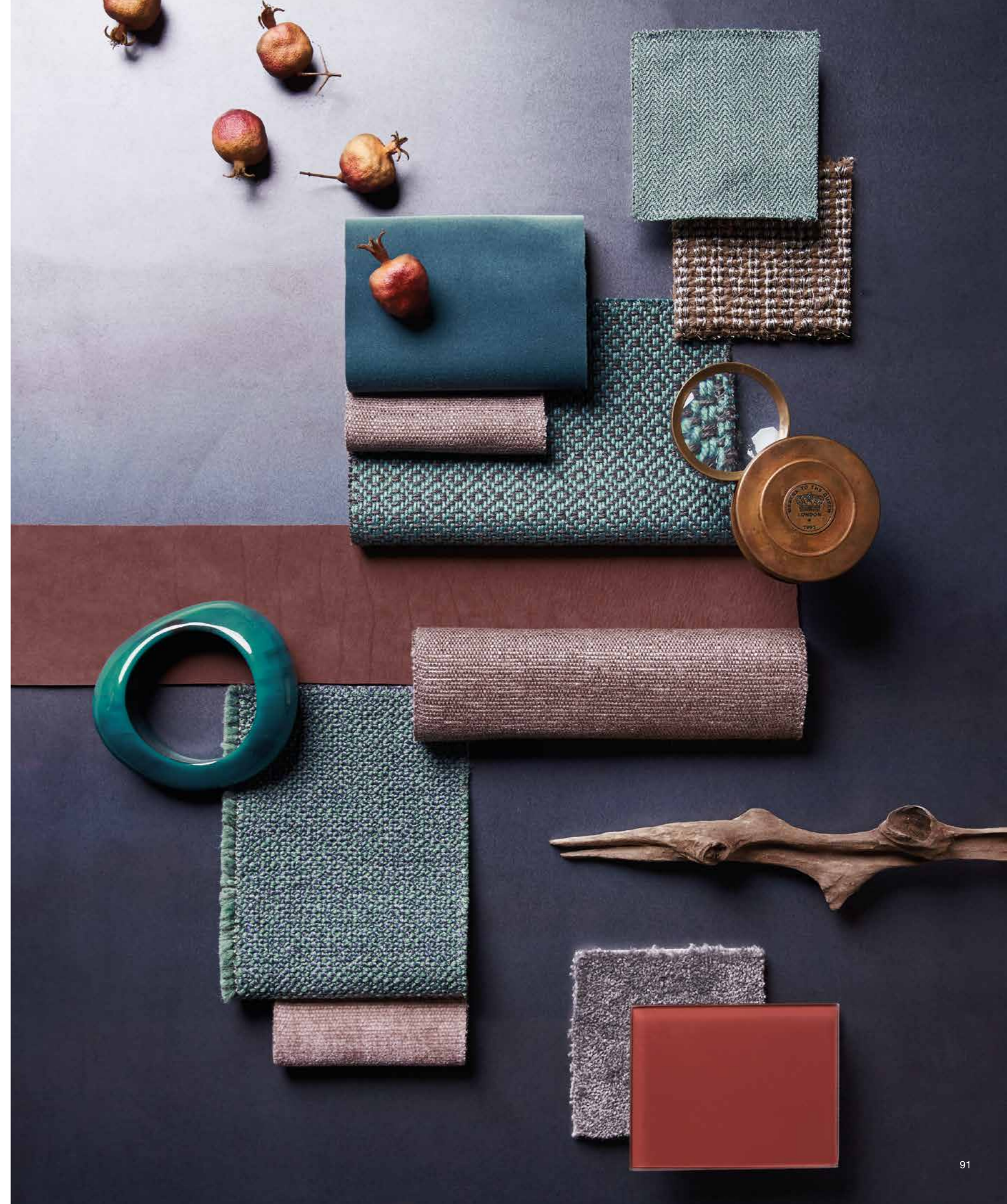



MATCHING *materials*

Gli elementi mobili ed i cuscini hanno un'innata versatilità a miscelare texture e materiali diversi creando un sofisticato bouquet sensoriale.

Un armonico abbinamento di pellami e tessuti esalta lo stile raffinato ma informale del divano. Grandi piani di seduta permettono di leggere la vita, la lavorazione e l'autenticità dei pregiati pellami.

Movable elements and cushions are characterised by an innate versatility, mixing textures and several materials to create a sophisticated sensory bouquet of sensations. The unexpected combination of leather and fabric enhances this sofa's refined yet cosy style.

Spacious base leather surfaces remind us of the unit's origin and, workmanship as well as the authenticity of refined leathers.







Ergonomic DESIGN

Un innovativo cuscino di schienale, senza componenti meccaniche, soffice ed accogliente, segue la naturale ergonomia del corpo e lo accompagna sino a sostenere la testa. Una nuova tecnologia permette ad un supporto interno di seguire il movimento delle spalle regalandoci un confortevole poggiatesta.

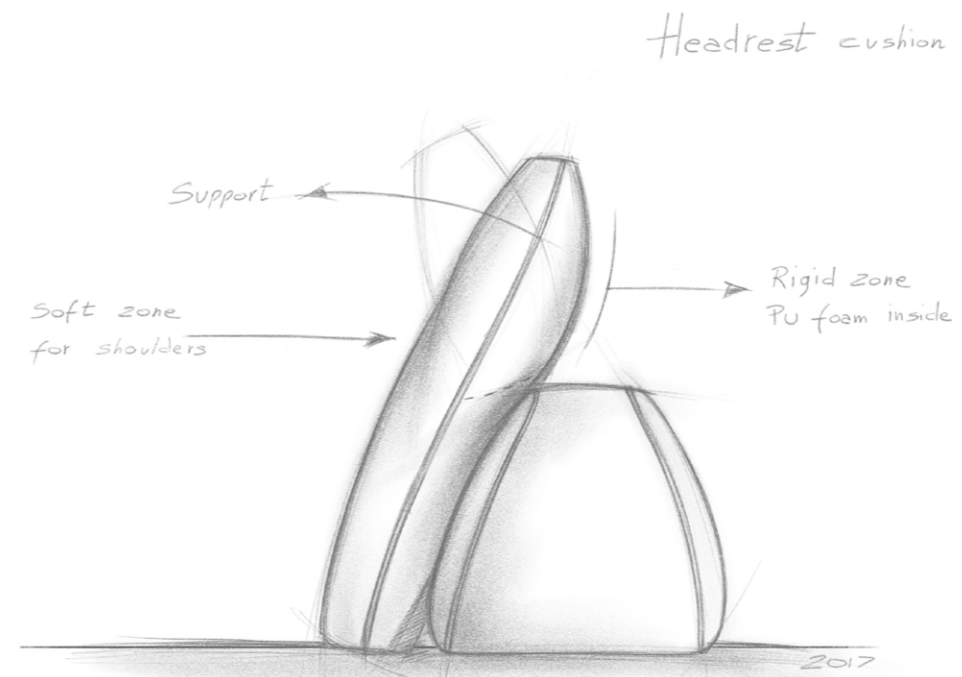

An innovative back cushion, devoid of mechanical components, soft, welcoming and which follows the body's natural ergonomics, supporting it right up to the head. This new technology provides interior support which follows shoulder movement, for a comfortable head rest.

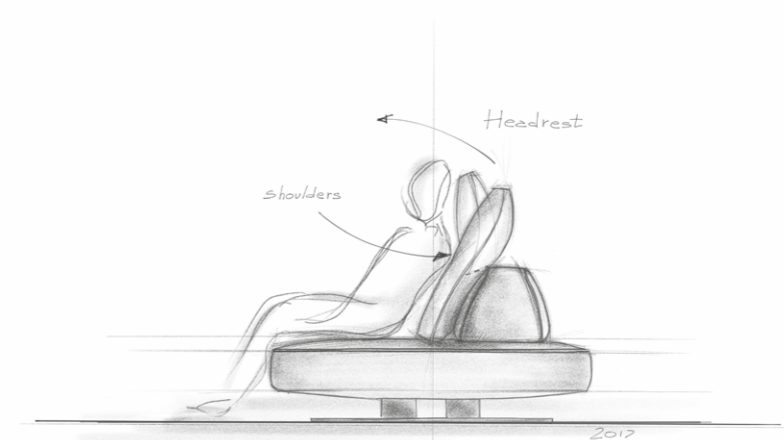



fango
leather hide
or lacquered

london
leather

grafite
leather hide
or lacquered

taupe
leather hide
or lacquered

silver
leather hide
or lacquered

ottanio
lacquered

Filiph tables

Una collezione di tavolini e pouf dalla forte personalità, per la combinazione di materiali e configurazioni, completano di funzionalità e stile la linea Filiph.

Le diverse altezze, forme e dimensioni dei piani ne moltiplicano le possibilità di utilizzo: in abbinamento ai divani oppure per realizzare un originale gioco di sovrapposizioni.

I piani sono realizzati in cuoio naturale o verniciati nelle esclusive nuances: Grafite, Silver, London, Ottanio, Taupe e Fango.

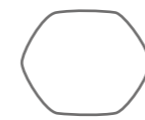

exagonal side table
(low or high)

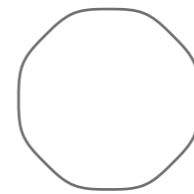

octagonal coffee table
92 x 92 cm

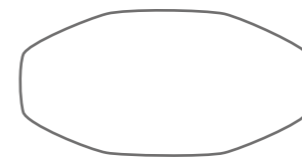

octagonal coffee table
160 x 80 cm

A collection of tables and poufs with a strong personality complete the Filiph range with functionality and style, through the combination of materials and configurations.

Different heights, shapes and sizes of surfaces multiply potential uses: in combination with sofas or for the creation of original staggered plays on juxtaposition.

Surfaces are in natural leather hide or painted in the following exclusive nuances: Grafite, Silver, London, Ottanio, Taupe and Fango.

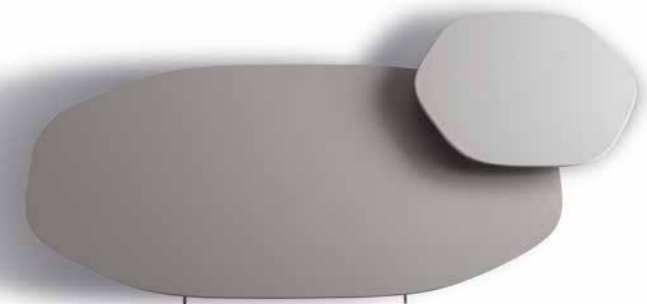



Filiph dining consolle è un oggetto progettato per assecondare nuove abitudini nel vivere lo spazio living e il divano. Abbinato al sistema a schienali mobili si adatta a tavolo dining, a scrivania per lavorare o semplicemente a coffee-table ergonomico per una pausa con amici.

Filiph dining console is an object designed to satisfy new habits of living in the living area and the sofa. Combined with movable backs system is suitable for dining table, a desk to work or simply ergonomic coffee-table for a break with friends.



DYNAMIC

Un piano versatile, libero di muoversi assecondando usi e funzioni che cambiano nel tempo e seguono i desideri: Dynamic è la sintesi di un progetto che studia nuovi stili di vita degli spazi abitativi prima di essere un semplice tavolo.

A versatile top, free to move in line with uses and functions which change over time and follow desires: Dynamic is the culmination of a project which studies new living interior lifestyles. Much more than a simple table.



DYNAMIC 130

DYNAMIC 80



L'area living cambia scenari e funzioni d'uso semplicemente variando posizioni e altezze degli elementi d'arredo.

I tavolini Dynamic attraverso un sofisticato ma intuitivo meccanismo consentono di variare l'altezza del piano modificando il loro utilizzo: da coffee-table a tavolo dining, da side-table a scrivania o piano di lavoro.

La mobilità degli schienali permette, inoltre, di creare comode sedute che si adattano a questi cambiamenti di funzione.

The living area changes scenarios and functions of use by simply varying the positions and height of furnishing elements.

Through a sophisticated yet intuitive mechanism, Dynamic tables make it possible to adjust the height of the top according to use: from coffee, dining to side table, desk or worktop.

Backrests mobility also enables the creation of comfortable seats which adapt to any changes in function.

DYNAMIC 110

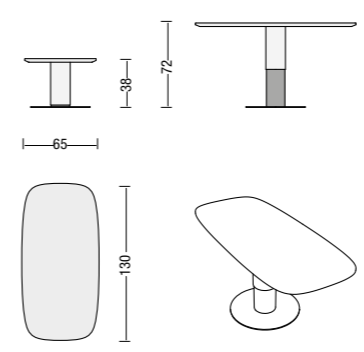

DYNAMIC 130

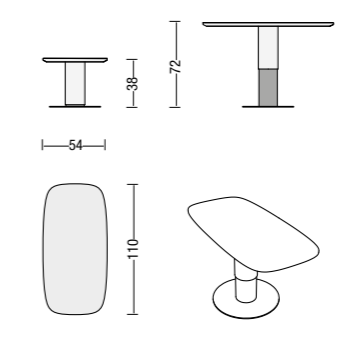

DYNAMIC 110

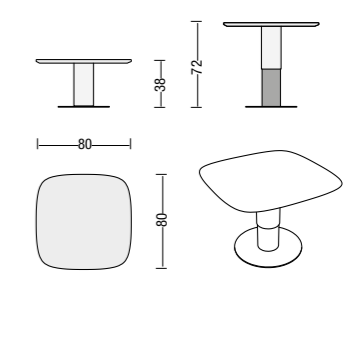

DYNAMIC 80



DY80 LTTP
Tavolo alzabile 80x80 cm
Basamento Peltro e nabuk, piano laccato Taupe

*Liftable table 80x80 cm
Pewter and Nabuk base, Taupe lacquered top*

coffee **REINVENTING** table

I cambiamenti di funzione d'uso sono permessi da un meccanismo esclusivo sviluppato da ARTNOVA in grado di passare da 38 cm a 72 cm di piano d'appoggio, con un movimento fluido regolabile in qualsiasi posizione.



Versatile use is guaranteed by an exclusive mechanism, developed by ARTNOVA, making it possible to transform the flat rest surface from 38 cm to 72 cm, with a fluid movement, adjustable in any position.



DY110 CSPT
Tavolo alzabile 110x54 cm
Basamento Peltro e Tecnonabuk, piano in cuoio Silver

*Liftable table 110x54 cm
Pewter and Tecnonabuk base, leather Silver top*



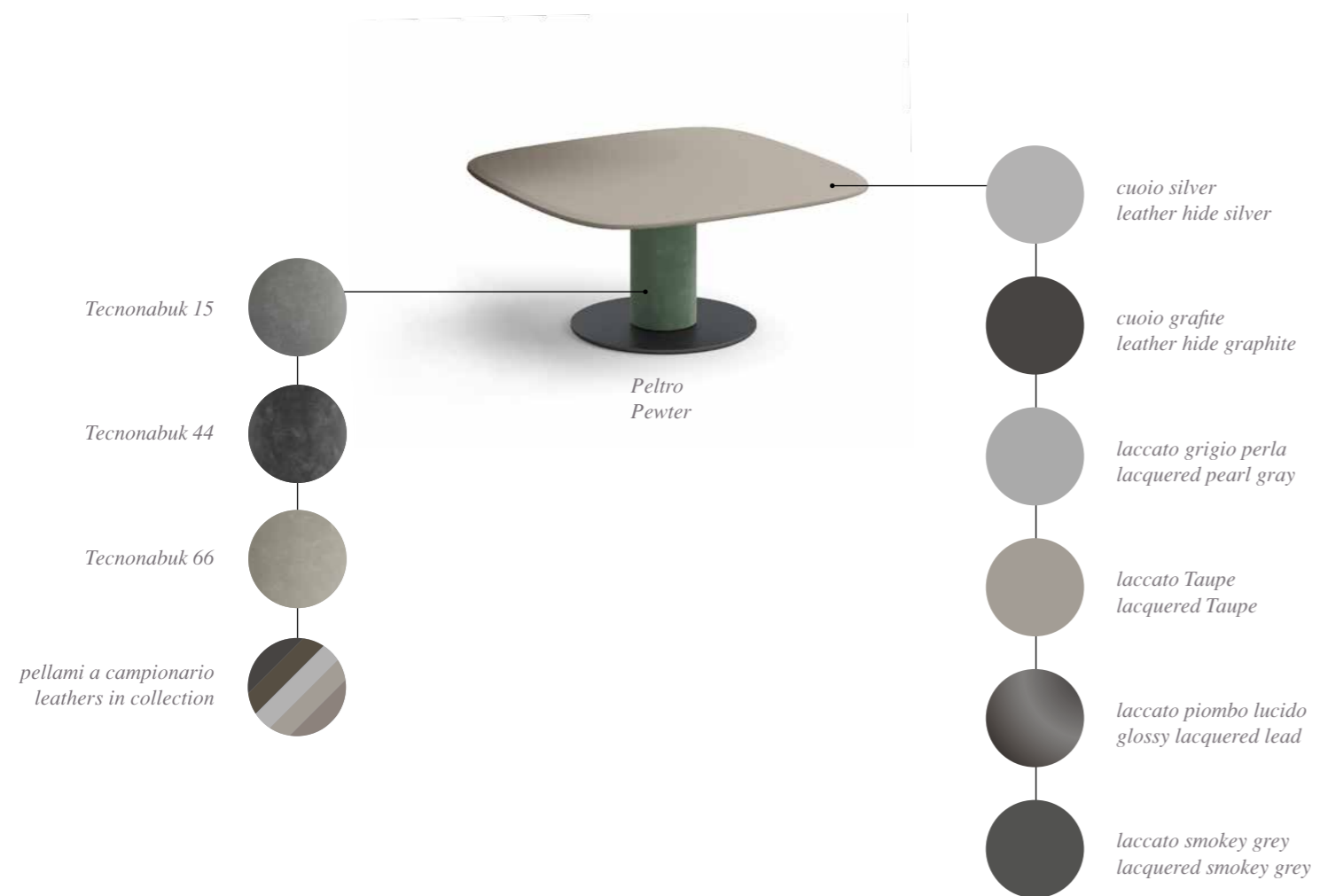

DY130 LYPP
Tavolo alzabile da 130x65cm, H 38-72cm
Basamento Peltro e Nabuk 24, piano laccato smokey grey

*Liftable table 130x65cm, H 38-72cm
Base Pewter and Nabuk 24 finish, top lacquered smokey grey*

LIVING

space evolution

Nuovi scenari

Lo spostamento degli schienali mobili e dei complementi permette di creare zone del living adibite a scenari e funzioni diversificate.

New scenarios

The changing position of the movable backrests and accessories allows creation of living areas used for diversified scenarios and functions.

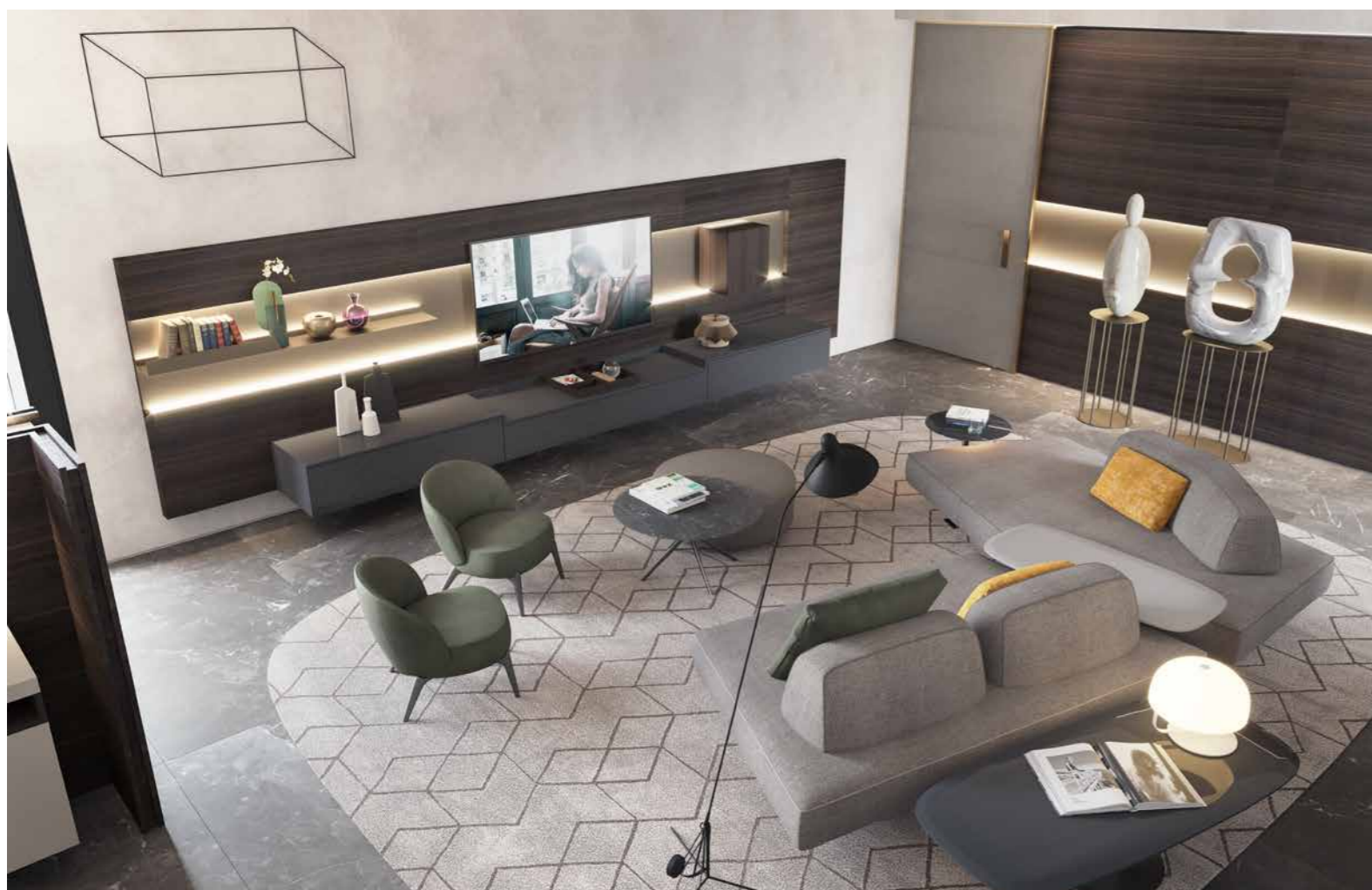
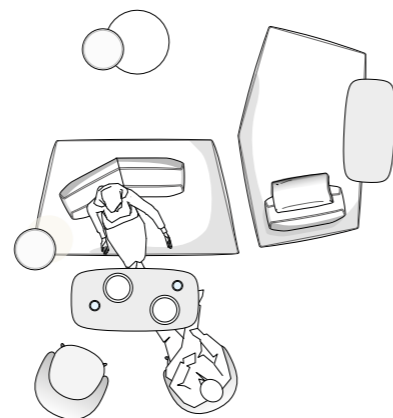
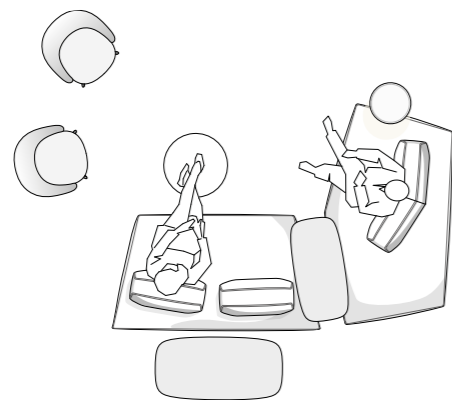

Energia e luce puntuale

Complementi wireless con luce e powerbank integrata consentono di portare energia all'occorrenza e definire utilità e scenari di luce illimitati e personalizzati.

Targeted energy and light

Wireless complements with light and integrated powerbank allow you to bring energy when needed and define unlimited and customized utility and light scenarios.

Spostabilità

Complementi e poltrone leggere realizzate con materiali innovativi, consentono di spostare gli elementi arredativi in funzione del bisogno.

Displace-ability

Light tables and armchairs made with innovative materials, allow to move elements where needed.

Cambi di funzioni d'uso

Tavoli e tavolini sono progettati per variarne l'altezza del piano e modificarne le funzioni d'uso: da consolle a dining, da coffee-table a piano di lavoro.

Displace-ability

Tables and coffee-tables are designed to allow you to vary the height of the top and modify its use functions: from console to dining-table, from coffee-table to worktop.

CLOUD

L'essenza dell'eleganza.

Un divano che rappresenta purezza del design contemporaneo evocando linee del passato.

Nuove forme raccordano basi e schienali in un gioco di volumi inaspettato, raffinato e leggero.

The essence of elegance.

The Cloud sofa represents a contemporary design of purity, bringing a touch from the past.

Brand new shapes, playing among the backrests and seats, create a refined and sophisticated environment.





ERGONOMICS *and enveloping lines*

Innovativi schienali si adattano all'ergonomia del corpo seguendo la sua naturale linea e accogliendo la testa. Tavolini e complementi ne completano funzionalità e comfort. I migliori materiali, frutto della ricerca italiana, compongono le imbottiture di CLOUD, divano che sorprende appena lo si prova.

Ergonomically adaptable innovative backrests follow the natural lines of the body and provide the ultimate accommodation for your head.

Side tables and accessories enhance the features and comfort. The best materials, the fruit of Italian research, compose the padding of CLOUD: a sofa that captivates you instantly.





Il sistema di sedute CLOUD unisce due anime: quella tradizionale e rassicurante delle linee accoglienti e pulite, e quella innovativa e tecnologica della struttura in alluminio e legno che permette di creare un sistema di schienali e basi modulari.

The CLOUD seating system combines two souls: the traditional and reassuring welcoming lines and clean, and that innovative and technological of the aluminum and wooden structure that allows to create a modular bases and backrests system.



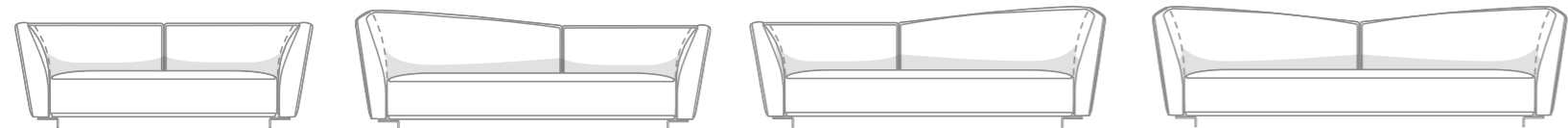

GAME *of* WAVES

Schienali e braccioli curvano abbracciando le basi in un gioco innovativo ed armonico di sinuose linee. Combinazioni di curve alte e basse differenziano la linea dei divani e degli elementi componibili. Ogni composizione si contraddistingue per un profilo unico e originale.

Backrests and armrests bend embracing the bases in an innovative and harmonic play of curvy lines. Combinations of high and low curves differentiate the elements of this sofa. Each and every composition is unique and stands out due to its original outline.

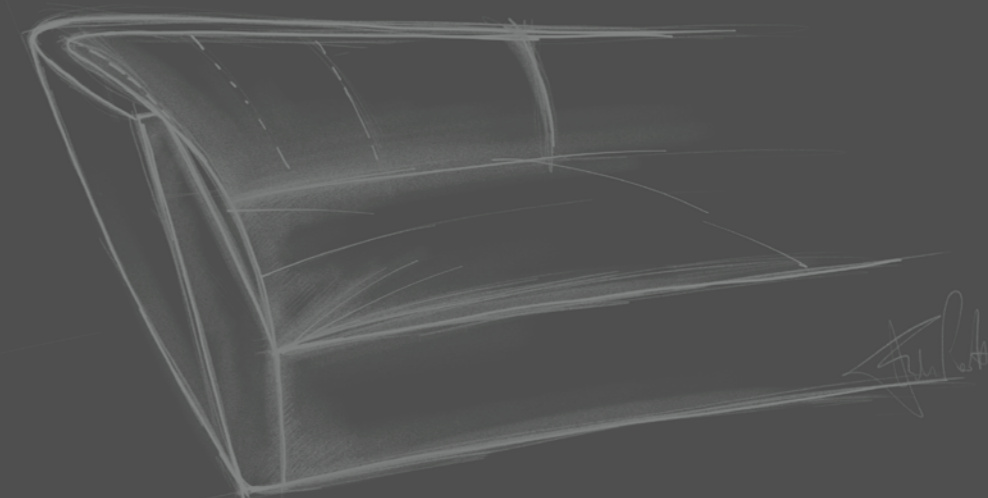

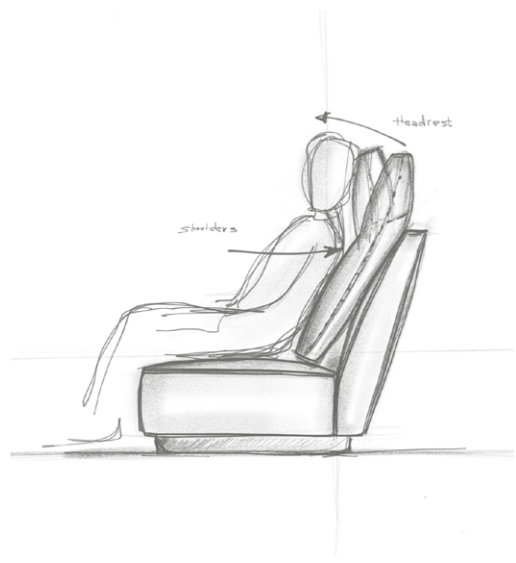

Headrest cushion

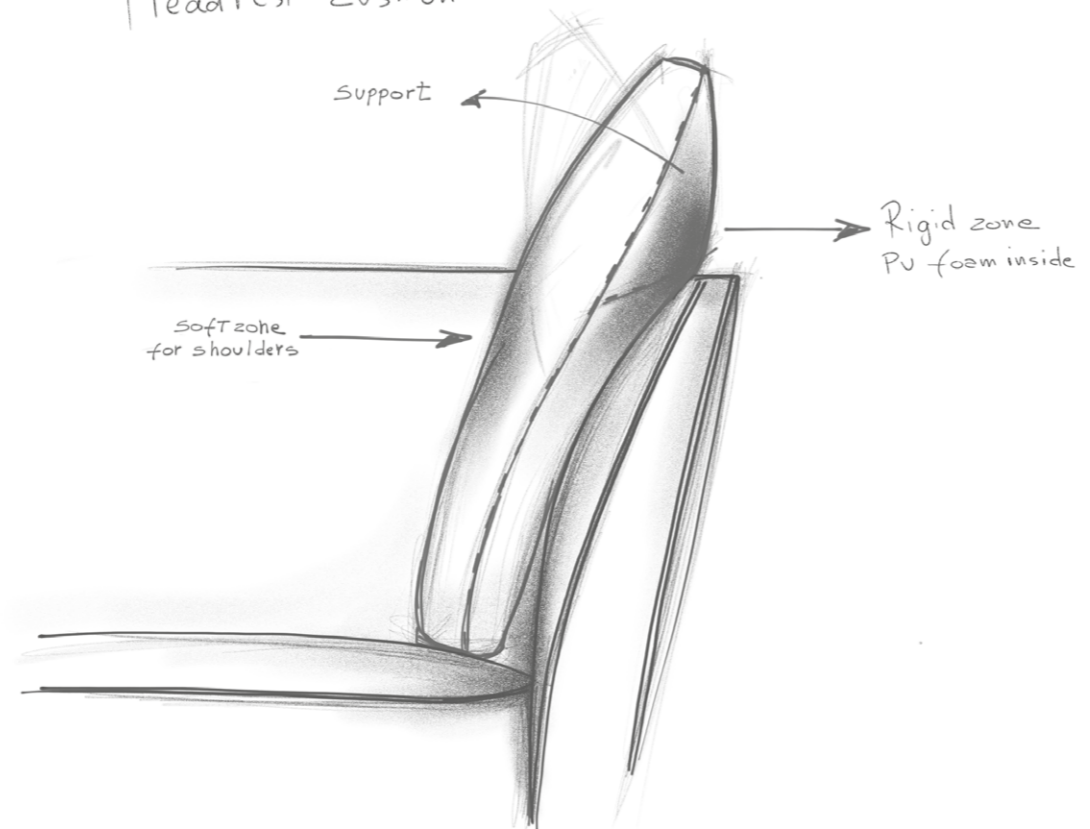



CLOUD Limited Edition

L'avvolgente struttura degli schienali si presta naturalmente ad un gioco di abbinamenti materici.

CLOUD LE è un'edizione limitata che si contraddistingue per la combinazione di diversi materiali sulla struttura del divano.

The enveloping structure of backs lends itself to a play of tactile juxtapositions. CLOUD LE is a limited edition which distinguishes itself in virtue of the combination of different materials on the sofa structure.





Tessuti, ricami, pelli o velluti si possono abbinare creando un gioco di colori o trame all'interno dello schienale. Miscelando materiali e texture si può personalizzare il divano e il progetto del proprio living creando un'immagine sofisticata e unica.

Fabrics, embroidery, leathers or velvets can be combined to create a play of colours or patterns within backs. Any sofa and living room project can be personalised by matching materials and textures, creating a sophisticated and unique image.

Plays on
Fabrics

Embroidery-finishing *fabric*

Un raffinato ricamo sulla ciniglia richiama le forme iconiche del design Art Nova.

Cloud LE vestito con i nuovi tessuti ricamati esalta l'eleganza e la preziosità del progetto.

Refined embroidery on chenille evokes iconic forms of Art Nova design. CLOUD LE covered in new embroidered fabrics exalts the project's elegance and prestige.



Cloudy white *elegance*

Una nuvola bianca riveste di soffice eleganza vellutati pellami ed esclusive finiture bronzate.

Una delicata miscela di miele, grigio e bianco, crea una nuance dal sapore caldo, avvolgente e contemporaneo. L'unicità di trame e ricami dona ai tessuti un innato fascino e preziosità.

A white cloud covers velvety leather and exclusive bronze finishes in soft elegance. A delicate blend of honey, grey and white creates a nuance characterised by a warm, cosy and contemporary flavour. The uniqueness of patterns and embroidery confers innate allure and exquisiteness upon fabrics.







FILIPH

Trasforma il modo di vivere il divano e introduce innovativi materiali che affascinano al primo approccio.

Si distingue per l'assenza totale di divisione rigida tra destra e sinistra, davanti e dietro.

La disposizione degli schienali mobili è libera e asseconda il proprio personale comfort e il modo di vivere lo spazio abitativo attorno a sé.

Transforms the way to experience your sofa, introducing innovative materials that capture your attention immediately. It's distinguished by the lack of rigid division between right and left, front and back.

The disposition of movable backrests is absolutely free and guarantees greatest comfort in your living space.





FILIPH ci lascia liberi di assecondare i nostri desideri di movimento. La seduta si accorcia e si allunga a piacimento, da formale a rilassata, si inverte creando conversazioni vis-à-vis, diventa chaise-longue per lettura e relax, sino a grande letto libero e indipendente.

FILIPH allows us to indulge our needs and desires for functionality and movement.

The backrests can be positioned into various configurations, from reduced to extended sitting, from formal to relaxed, inverted to form face to face conversations or transformed into a chaise-longue, and finally, into a free-standing large bed.





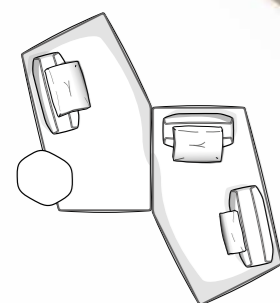
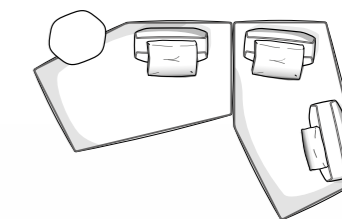

PENTAGONAL *shapes*

Poligoni irregolari e simmetrici si accostano tra loro delimitando spazi dinamici ma funzionali.

La forma pentagonale è studiata per accostarsi indifferentemente con divani a profondità 110 e 125 cm. E' invertibile, diventando a piacimento destra o sinistra.

Irregular and symmetrical polygons combine with each other to define a dynamic and functional space.

The pentagonal shape has been studied to combine perfectly with sofas 110 or 125 cm depth.

It's reversible and can be positioned right or left as you please.



matching LEATHER and FABRIC

Un inaspettato abbinamento di pellami e tessuti esalta lo stile raffinato ma informale del divano.

Gli elementi mobili ed i cuscini hanno un'innata versatilità a miscelare texture e materiali diversi creando un sofisticato bouquet sensoriale.

An unexpected combination of leather and fabric enhances the refined yet cosy style of the sofa. Movable elements and cushions have an innate versatility to mix textures and several materials creating a sophisticated sensory bouquet of sensations.





TASTE *of* DETAILS

FILIPH ha una linea morbida ma definita da profili ed elementi mobili dal design scultoreo. Sofficità e rigore si miscelano creando un'elegante presenza tessile. L'isola è leggera grazie alla forma a 45° della base.

FILIPH' sculptural design has an understated elegance, thanks to the combination of its soft flowing shapes and rigorous lines. It is notable the angular shaped base, at 45°, which donates a great sense of lightness.





on the *Rocks* Sunset

Gocce di ruggine lambiscono
i colori della terra, delle pietre,
della sabbia fine al tramonto.
La casa si colora elegantemente
di materici riflessi caldi
che illuminano i rassicuranti
toni dei grigi e dei beige.

*Drops of rust lightly caress
earth, stone, sand colours,
until sunset.*

*The home is elegantly coloured
by warm, textured reflexes which
illuminate reassuring grey
and beige tones.*



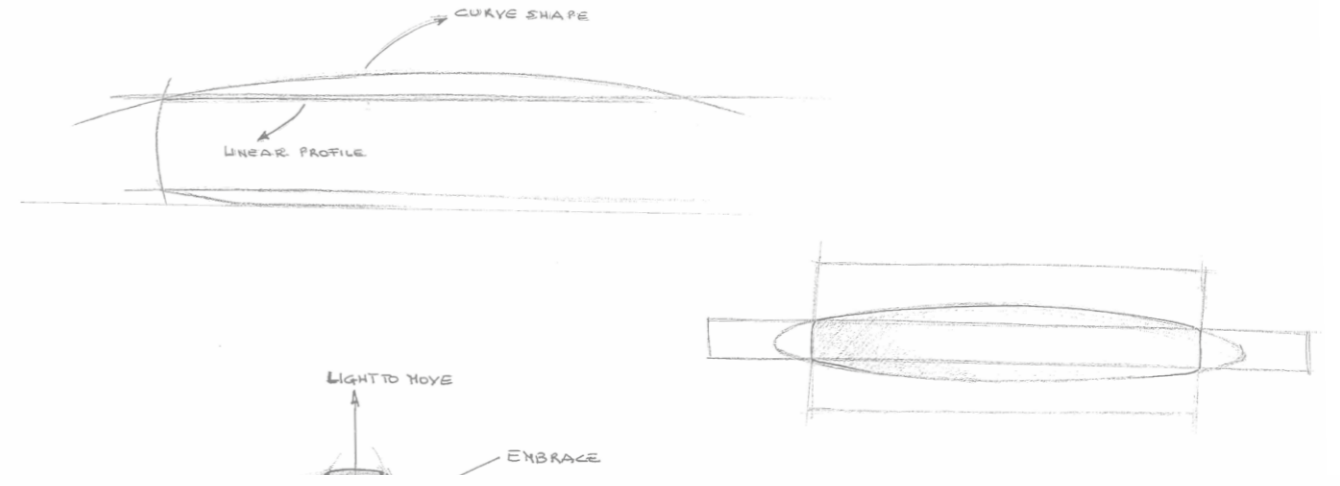
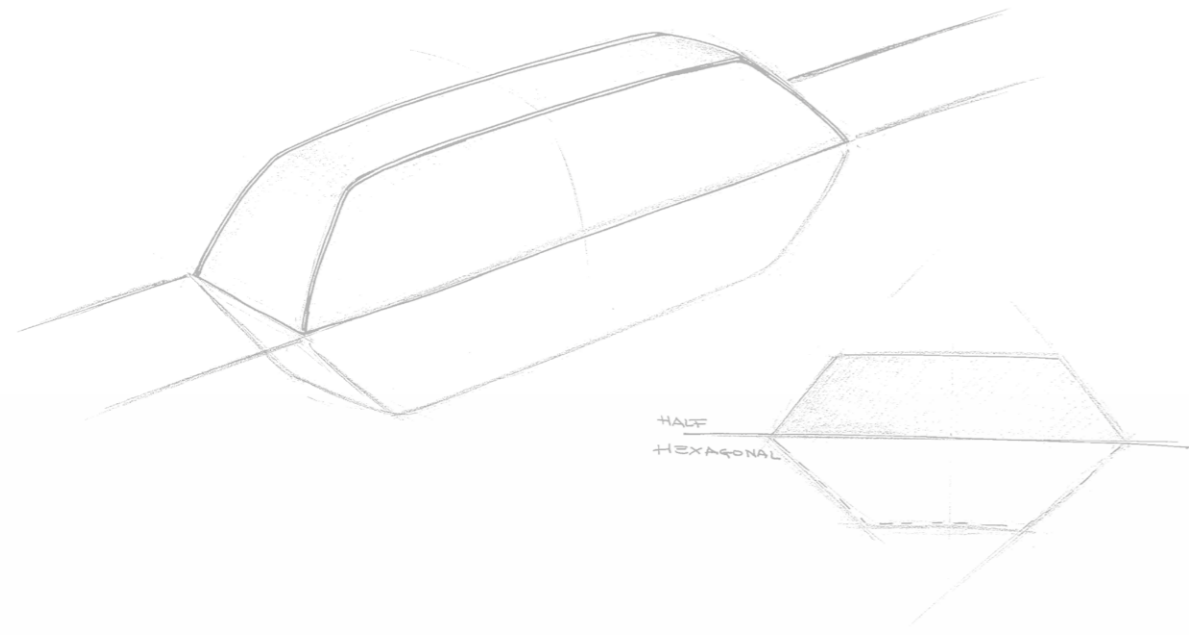

Advance DESIGN culture

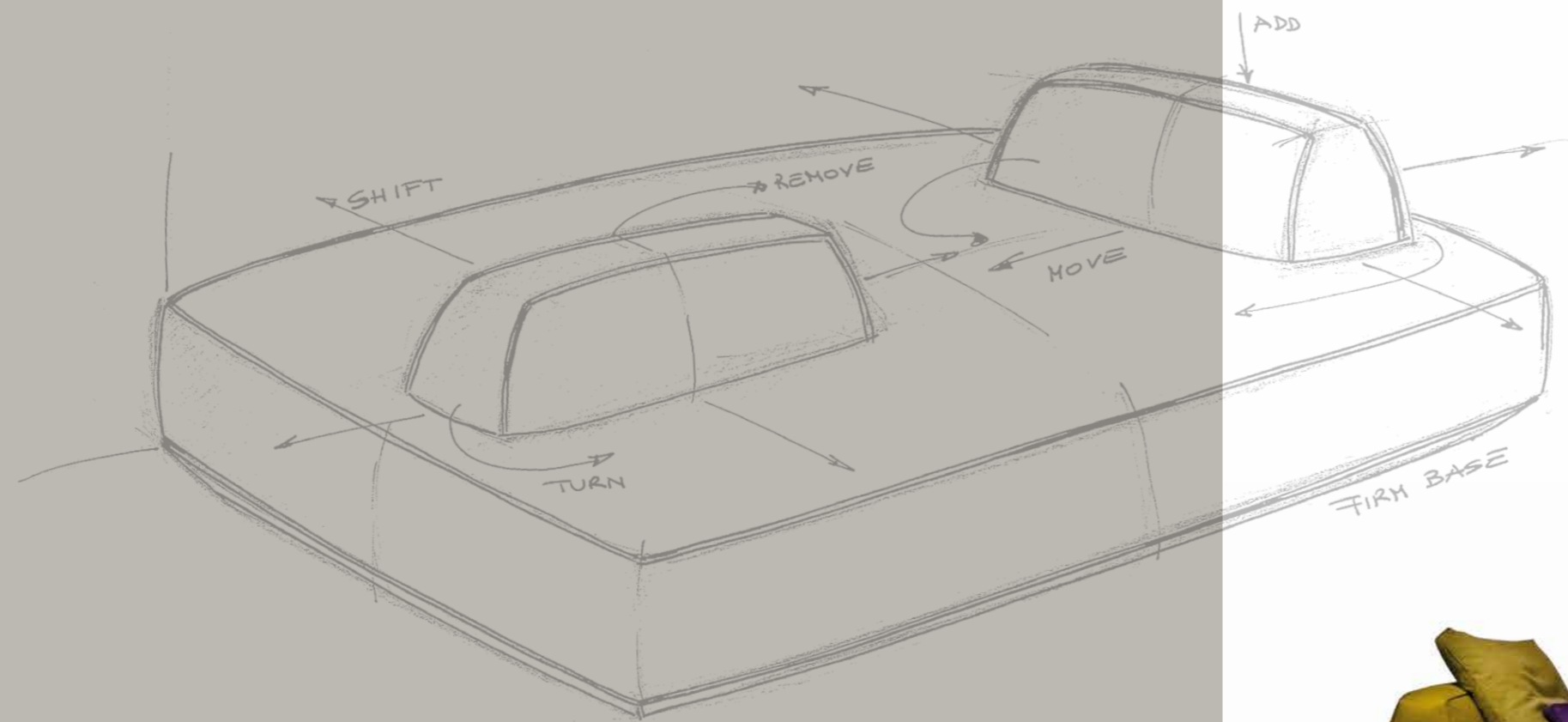

*"The name FILIPH is a game of changed letters.
Like the sofa: you can use it front side and back, changing and moving elements"*



Le isole destrutturate con schienali e braccioli mobili possono trasformarsi creando configurazioni di composizioni sempre diverse e legate all'esigenza del momento.
L'assenza di strutture fisse crea apertura e condivisione in qualsiasi ambiente lo si inserisca.

The detached elements, with movable armrests and backrests, can be transformed to create various configurations and compositions depending on your needs. This allows you to create a feeling of openness and space in any room.







Ricerca PROGETTAZIONE e innovazione

Materiali innovativi ed ecocompatibili, nati dall'esperienza della moda, accolgono con una soffici ta inaspettata e mantengono nel tempo la forma della seduta.

Speciali poliuretani ad elevata traspirabilit  ed elasticit  e materiali di derivazione nautica consentono agli schienali di spostarsi e nello stesso tempo di ancorarsi in qualsiasi posizione.

Gli schienali mobili sono progettati per accogliere anche due persone in appoggio o garantire un sostegno alto se dotati di cuscini accessori in Hi-tex.

The movable backrest has been designed to accommodate two people.

The support of an additional Hi-tex accessory cushion, guarantees high backing for maximum comfort.

Innovative and environmentally friendly materials, born from the fashion industry, welcome an unexpected softness.

Special high resilient and elastic polyurethanes, along with materials of nautical derivation, allow free movement of the backrest, but at the same time, immediate anchor it in any position.



NOTHING MORE *than bed*

Una morbida e leggera housse è un accessorio indispensabile che veste il divano proteggendolo con l'eleganza di un abito su misura e la leggerezza di un lenzuolo appena stropicciato. Ora il divano è pronto per trasformarsi in un comodo e spazioso letto a una piazza e mezza.

A soft and light cover ("housse") is an essential accessory that dresses the sofa, protecting it with the elegance of a tailor-made suit and the lightness of a bed sheet. Now the sofa is ready to turn into a comfortable and large bed.



FILIPH *outdoor*

A bordo piscina, sotto un ampio patio, una piccola veranda, o semplicemente sulla terrazza di una villa al mare: FILIPH OUTDOOR è costruito e studiato con innovativi materiali adatti ad un utilizzo open-air.

Le sue linee morbide, scultoree e il suo utilizzo flessibile esaltano le qualità del divano ogni volta lo si viva all'aria aperta e non solo.

Una collezione di speciali tessuti outdoor ne completano le caratteristiche di durata agli agenti atmosferici.

Designed and constructed with the most innovative materials suited for open-air use: FILIPH OUTDOOR is a brilliant solution to a large patio, small veranda, to an intimate setting by the pool, or simply on a terrace of a villa overlooking the sea.

Its soft, sculptural shapes and its flexible use emphasize the quality of the sofa, enabling you to enjoy it everytime whilst in the open air and indoors.

A collection of specific outdoor fabrics complement the characteristics against various atmospheric conditions.

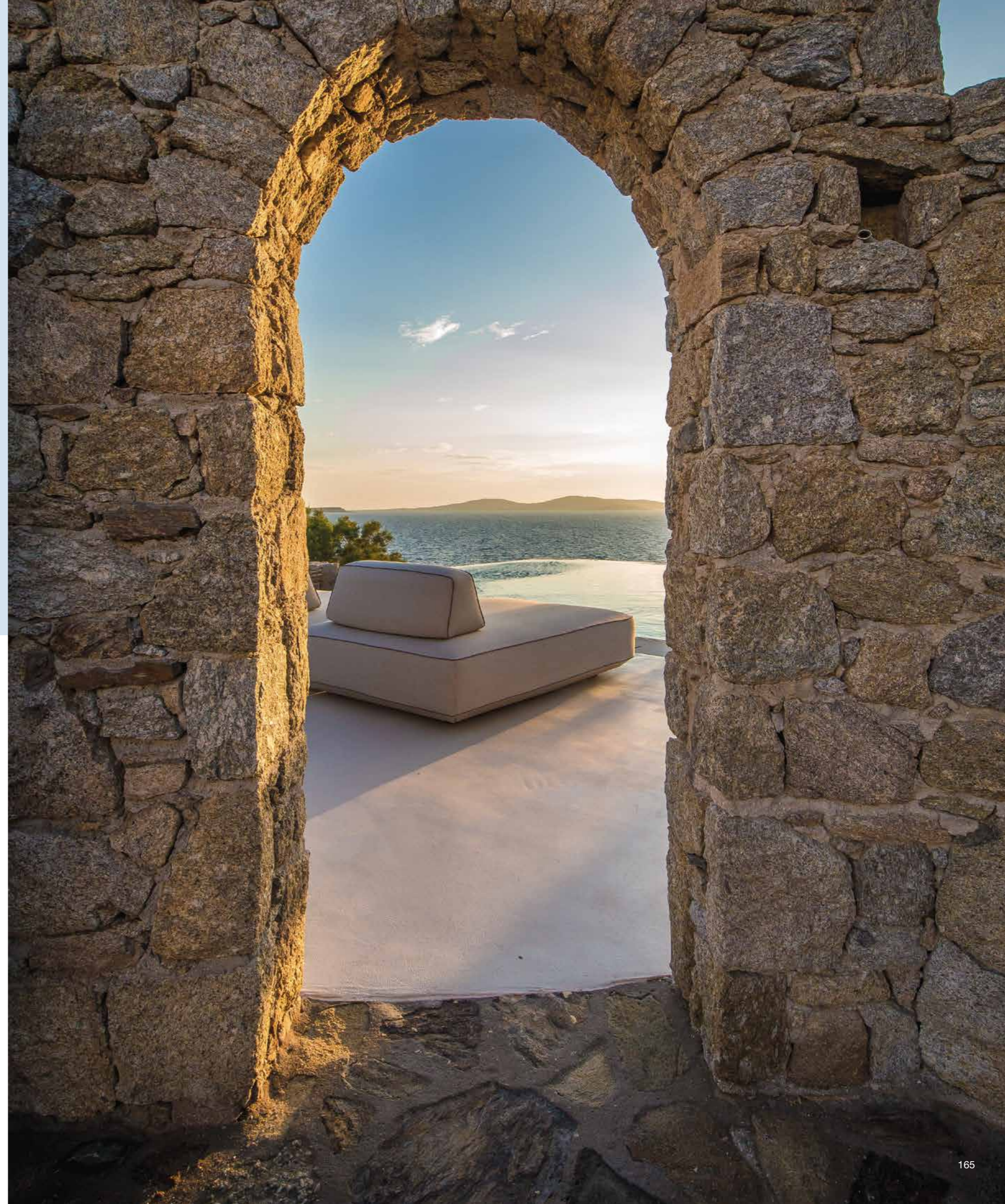



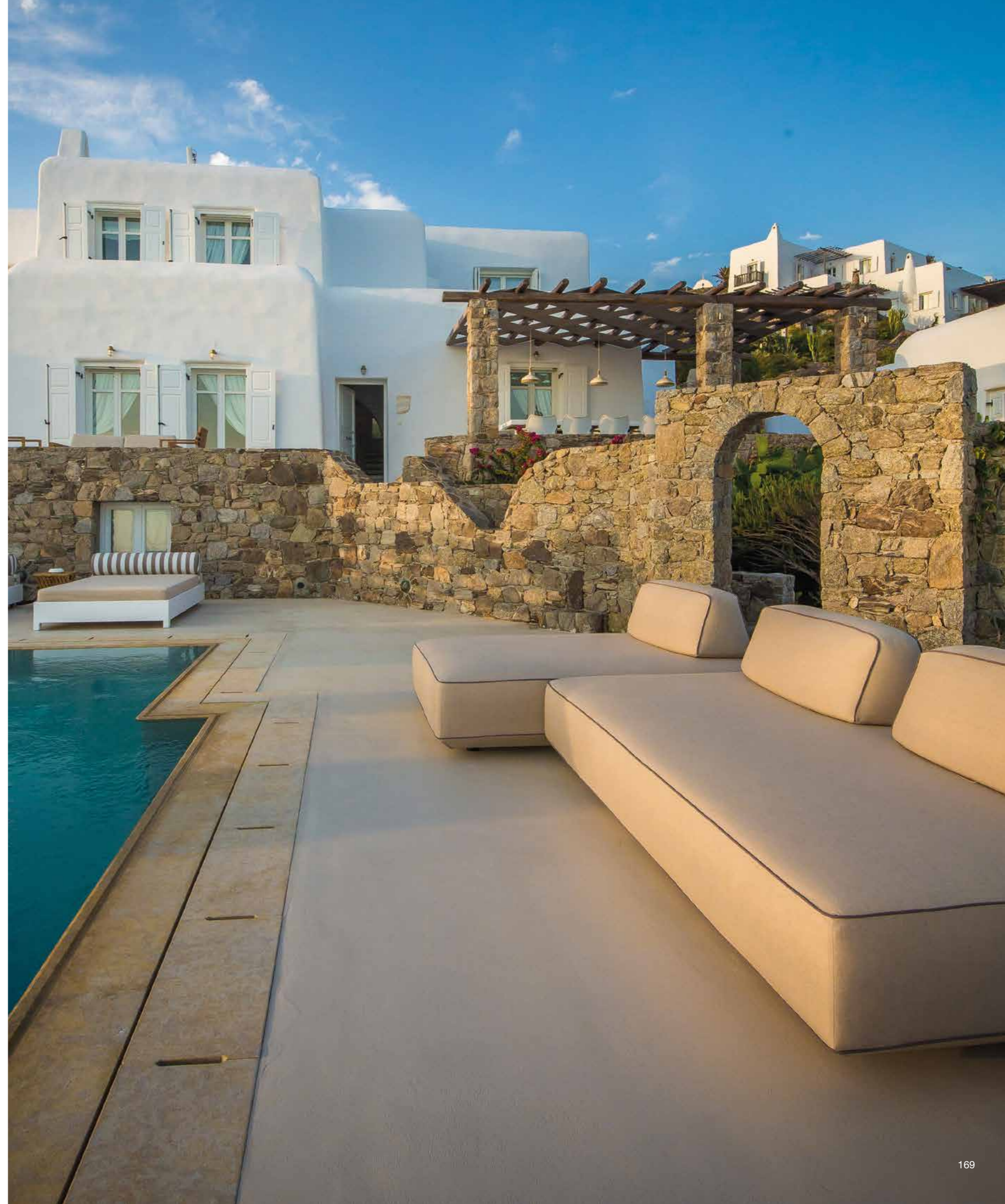



OLTRE

Volumi morbidi e scultorei abbinati a ricercati particolari di sartoria tessile raccontano un divano "a pozzetto" raffinato ed elegante.

La cucitura "a profilo" corre sulla struttura delineando i contorni e dando rigore alle accoglienti linee curve.

La soffici ta e la naturale caduta della piuma e del piumino regalano, in contrasto, morbidezza e flessibilit  di comfort.

La base della seduta sfuma verso terra creando, avvicinandosi al divano, un effetto di volume "aereo".

Soft and sculptural shapes, along with gracefully refined tailor-made details, describe this unique and elegantly designed sofa.

The trim outlines the structure and delineates the profile, giving a rigorous aspect to its curvaceous lines.

Natural and flowing qualities of down feather donate ultimate softness and comfort.

The base of the structure fades into the ground, generating an "airy" volume impression.



Esclusive lavorazioni RACCONTANO *i materiali*

OLTRE nella scenografica versione in pelle abbina pregiati ed esclusivi pellami a cuciture "al vivo" che esaltano la natura del cuoio. I grandi piani di seduta e struttura permettono di leggere la vita, la lavorazione e la texture della materia. Mentre velluti, tessuti e trame vestono le cuscinerie creando delicati ed esclusivi contrasti sensoriali.

In its scenographic leather version, OLTRE presents an exclusive upholstery with sharp edge stitchings, which highlight the exquisite nature of the leather.

The wide surfaces of the structure allow you to appreciate the origins and workmanship of the precious materials.





OLTRE richiama linee e finiture di memoria ma stupisce con un design nuovo e ricercato. Raffinati dettagli costruttivi e cuscinate in piuma dolcemente scomposte creano inaspettati contrasti sensoriali.

OLTRE recalls classical silhouettes and finishings, but dazzles with a new and authentic design.

Refined details, smooth fabrics and wavy cushions create an unexpected sensory contrast.



Golden drops *on the earth colors*

Bionde piume illuminano i toni della terra.

Una texture dorata cade sui legni che richiamano colori antichi e rassicuranti.

Uno spazio intimo ci accoglie in casa, tortora e blu notte disegnano pregiati divani, mentre morbidi accessori dai riflessi cangianti danno luce alla matericità del pellame.

Blonde features illuminate earth tones. A golden texture lightly falls onto woods which conjure up ancient and reassuring colours. An intimate space welcomes us to our home; dove grey and midnight blue design refined sofas, whereas soft accessories with iridescent reflexes enrich leather textures with light.





SQUARE LINE

Rigoroso e morbido al contempo:

SQUARE LINE definisce una presenza elegante e materica ma non invadente.

I cuscini di varie densità e dimensioni avvolgono la schiena senza ingombrare visivamente.

La seduta avvolgente ed elastica mantiene un gusto composto.

Il gioco dei cuscini consente configurazioni tradizionali o soffici e sofisticate composizioni tessili, dove vuoti e pieni risaltano le linee continue della struttura.

Rigorous, but at the same time delightfully soft, SQUARE LINE defines pure elegance. The cushions of various dimensions and density, wrap around the backrest, without obstructing the fine linear design. Different cushion combinations consent traditional configurations or soft and sophisticated textile compositions.







L'esclusiva versione SQUARE LINE STEEL mostra finiture preziose grazie al basamento in metallo dal design originale e dalle finiture personalizzabili. Complementi e accessori in pelle e cuoio ecologico giocano con le finiture in metallo della base creando un'immagine raffinata e innovativa del divano.

The exclusive version of SQUARE LINE STEEL displays a precious finishing thanks to its finely designed metal base. Accessories in leather and exclusive fabrics play along with the metal base, creating an innovative and refined image of sofa.



SQUARE LINE VENTICINQUE STEEL: versione del divano con bracciolo da 25 cm e basamento in metallo
SQUARE LINE VENTICINQUE STEEL: 25 cm armrest and metal base sofa version

SQUARE LINE si modella al corpo grazie a più profondità e altezze personalizzate e diverse densità di materiali tradizionali o innovativi.

Due diverse profondità e due altezze di seduta, tre differenti materiali di imbottitura nei sedili e due negli schienali, creano 24 diverse combinazioni di comfort: la totale personalizzazione di immagine e funzione.

SQUARE LINE perfectly adjusts to the body thanks to its customizable height and depth, along with different densities of modern and traditional padding materials.

Two different depths and two heights, three different padding materials for seat cushions and two different backrest cushions, contribute to create 24 different combinations of comfort: total customization of image and function.



SQUARE LINE VENTI: versione del divano con bracciolo da 20cm
SQUARE LINE VENTI: 20 cm armrest sofa version

Custom-made COMFORT & SIZE



materials RESEARCH

Tradizione e tecnologia si esaltano a vicenda risaltando finiture sartoriali e un comfort inaspettato.

Piume e piumini giocano e si completano con imbottiture innovative in memory foam, polilatex e microfibre Hi-tex.

Tessuti tradizionali o vintage, pellami preziosi, accessori in cuoio ecologico e acciaio, velluti e lini, creano mix materici e di texture contemporanei ed esclusivi.

Tradition and technology underline finelytailored look and unexpected comfort. Down and feather complete the innovative padding in memory foam, polilatex and Hi-tex microfiber.

Conventional or vintage fabrics, precious leathers, eco-friendly accessories and steel, velvet and linen: create a mixture of contemporary and exclusive textures.









Vestito con cuscini liberi di varie densità e dimensioni, SQUARE LINE si caratterizza per i contrasti fra linearità e morbidezza, dove vuoti e pieni risaltano le linee continue della struttura. I cuscini avvolgono la schiena e sostengono la testa senza ingombrare visivamente. Si adagiano al corpo avvolgendolo nell'impalpabile sostegno della piuma.

Surrounded by free cushions of various dimensions, SQUARE LINE is characterized by the sharp contrast between linearity and softness. The cushions wrap the back supporting the head, maintaining a light aesthetics: recline your body by folding it into the impalpable feather padding.

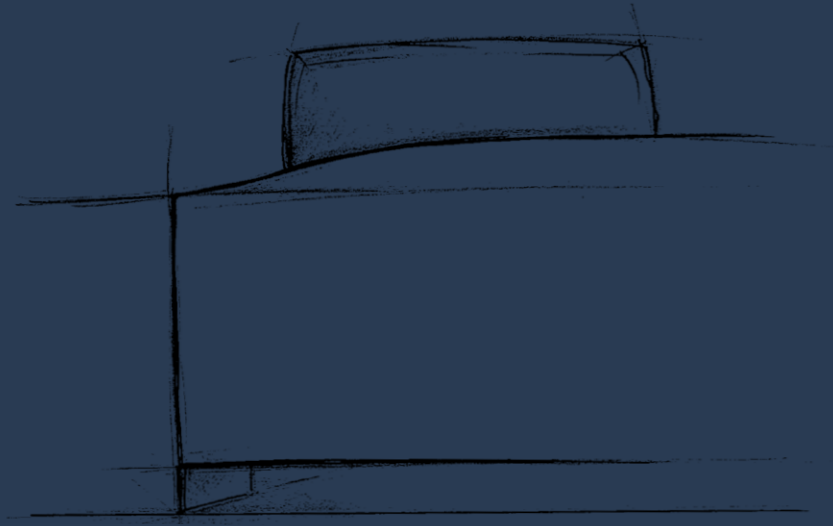

BLUM

Leggerezza nell'immagine, dettagli raffinati e comfort in seduta rappresentano le qualità di BLUM.

BLUM avvolge il corpo grazie all'abbinamento di materiali tradizionali ed innovativi, accogliendolo con un sostegno personalizzato da diverse imbottiture e schienali ergonomici.

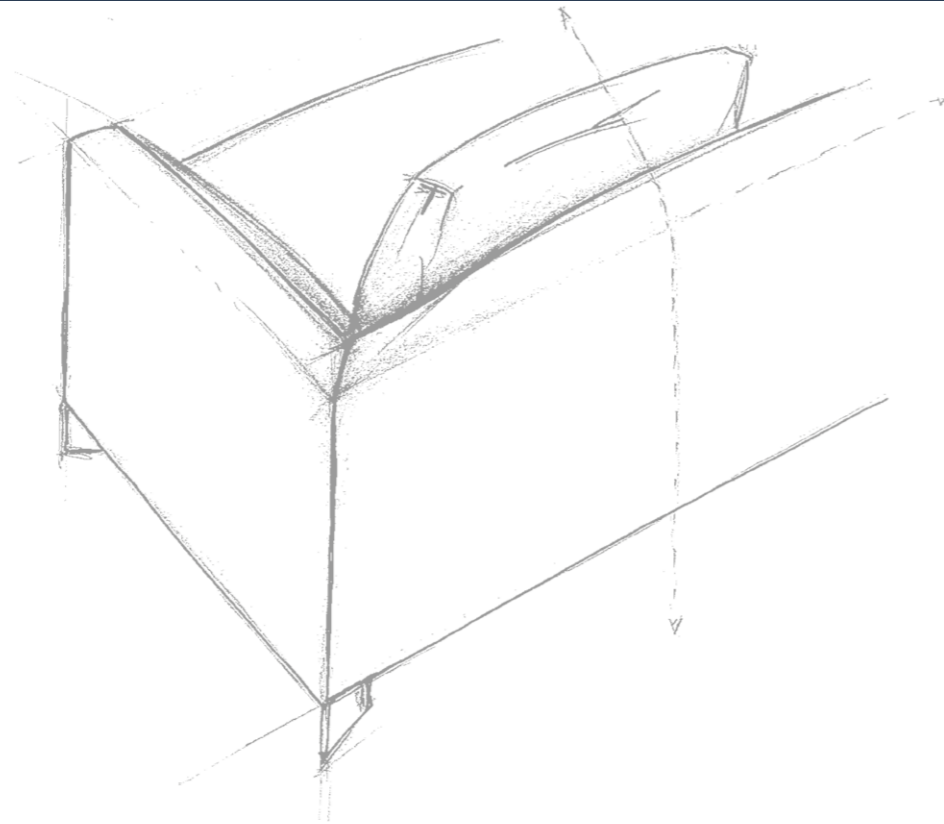

Visual Lightness, skillfully crafted details and comfort of the seating represent essential qualities of BLUM. BLUM embraces the body due to its various combinations of conventional and innovative support of different padding and ergonomic backrest.









Tailored DESIGN creations

BLUM offre un sostegno alto ed ergonomico grazie alla sapiente miscela di materiali tradizionali e imbottiture di nuova generazione. Tradizione e tecnologia si esaltano in un divano sartoriale dalle innovative soluzioni strutturali ma dall'immagine senza tempo.

BLUM offers high ergonomic support featured by traditional materials and innovative polyurethane foams. A Bespoke sofa that combines tradition and technology, together with innovative structural solutions.



Blue velvet *lights up antique brown*

Intensi velluti blu e lucidi riflessi del metallo vissuto illuminano profondi ed eleganti colori minerali. Grigi e marroni si fondono. Una sfumatura di giallo richiama l'attenzione e sottolinea la trama del tessuto che ci avvolge.

Intense blue velvets and the shiny reflexes of worn metal illuminate deep and elegant mineral colours.

Greys and browns merge. A shade of yellow captures the attention and emphasizes the patterned fabric which envelops us.

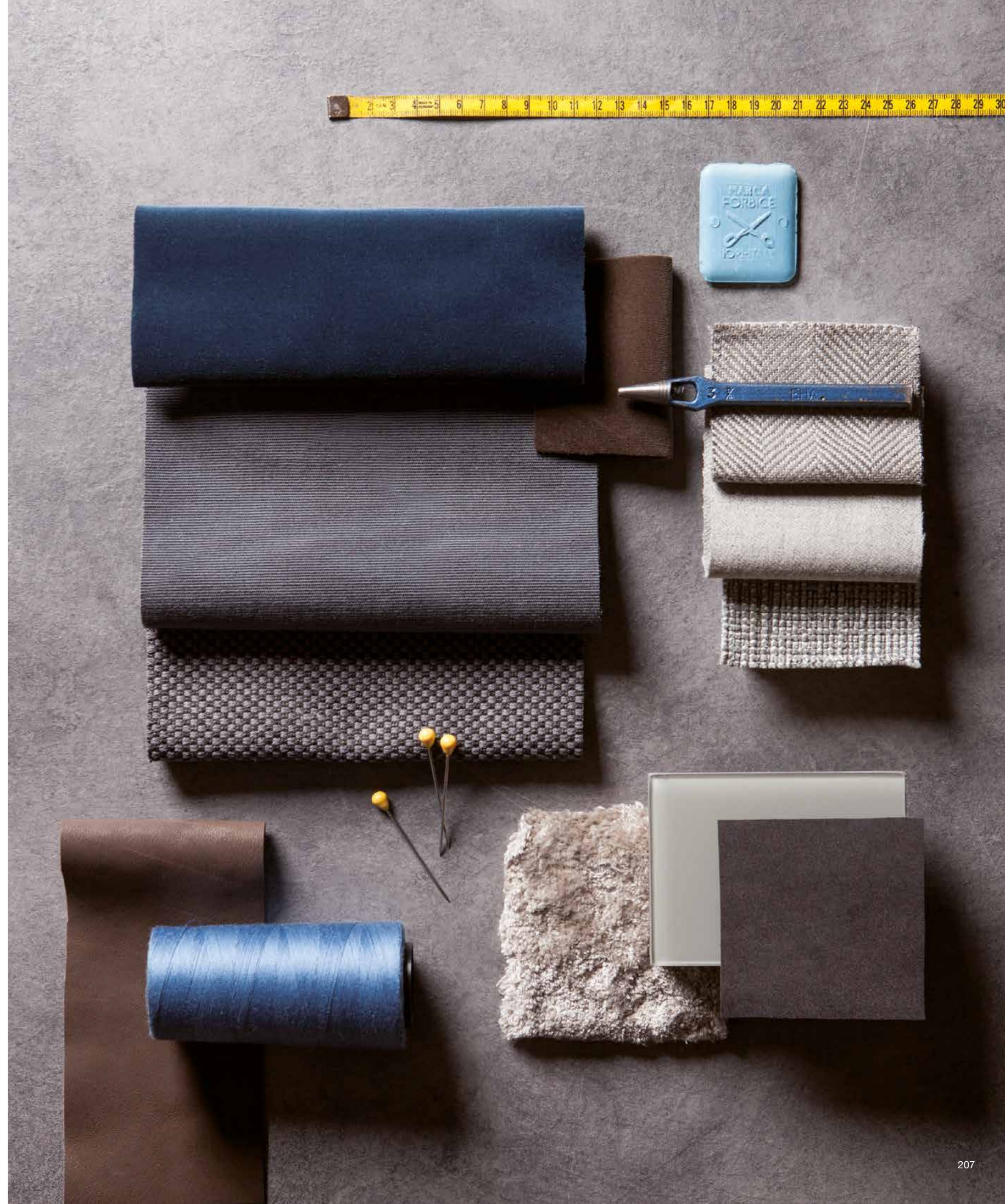

WILL

La struttura sospesa e le lunghe sedute intere raccontano un divano dai volumi leggeri ed aerei.

Eleganti profili percorrono le forme morbide del divano e degli schienali creando un gioco di incroci tessili, mentre braccioli e schienali si uniscono alla struttura creando un raffinato gioco di volumi.

The light structure and long seating cushions portray an "airy" image of sofa. Fabric pipings go through the soft shapes of the structure and the cushions, highlighting the modern lines of WILL.

Armrest and backrest join the structure creating a delicate play of different depths and volumes.

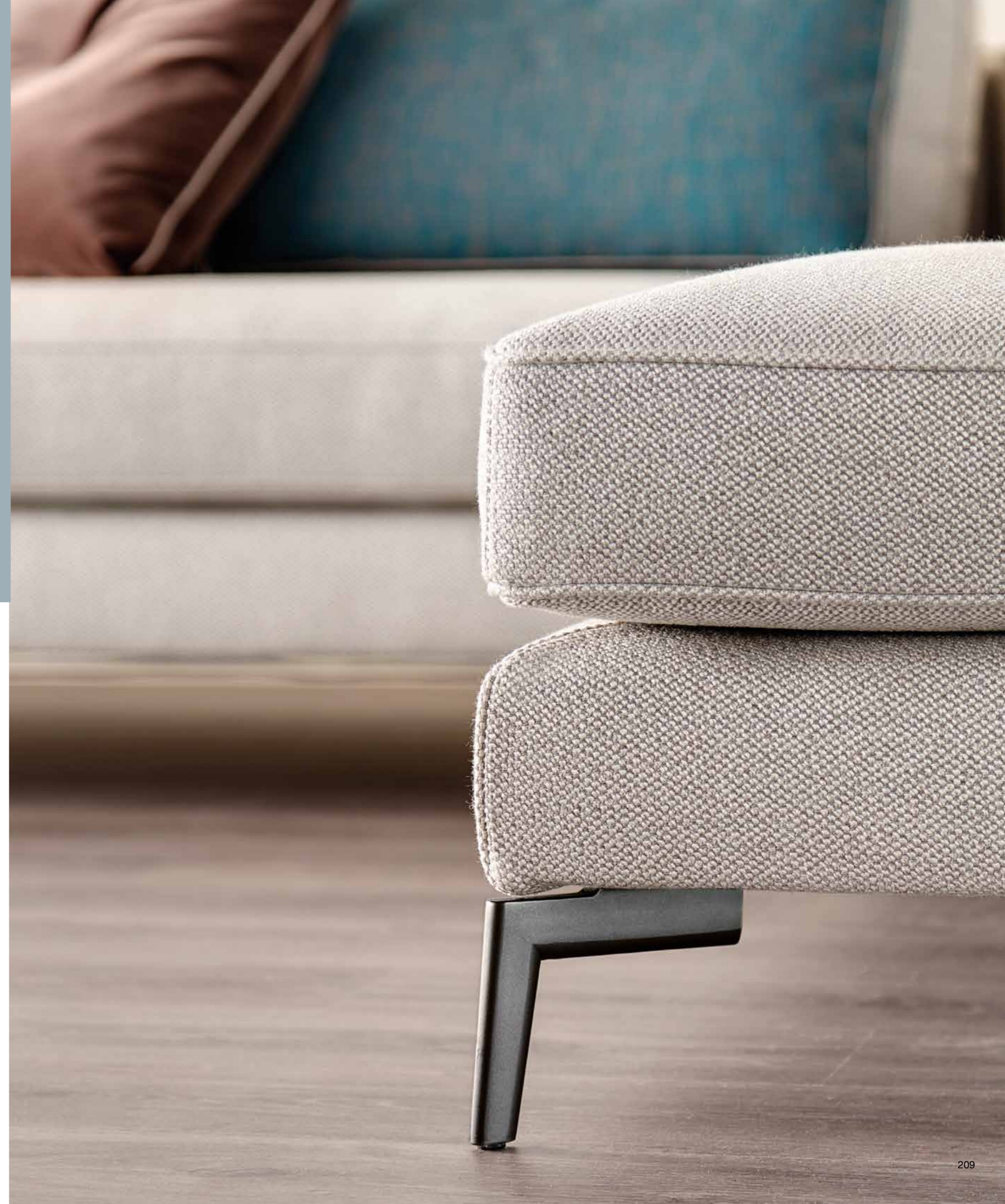





Divano WILL da 265 cm nella versione con 2 schienali L
WILL 265 cm sofa with 2 L backrest cushions configuration



Divano WILL da 265 cm nella versione con 3 schienali M
WILL 265 cm sofa with 3 M backrest cushions configuration





Refined
ATTITUDE
Elegance





Oriental memories *teal painted*

Un'impronta ottanio colora di seduzione i toni naturali dei lini. Ombre color caffè giocano con sfumature magenta e segni di bianco, evocando esotiche memorie. La casa si tinge del nostro vissuto e del desiderio di esplorare nuovi abbinamenti.

A teal print adds a touch of seduction to natural linen tones. Coffee shades play with magenta shades and white signs, evoking exotic memories. The home is coloured with our experience and desire to explore new combinations.

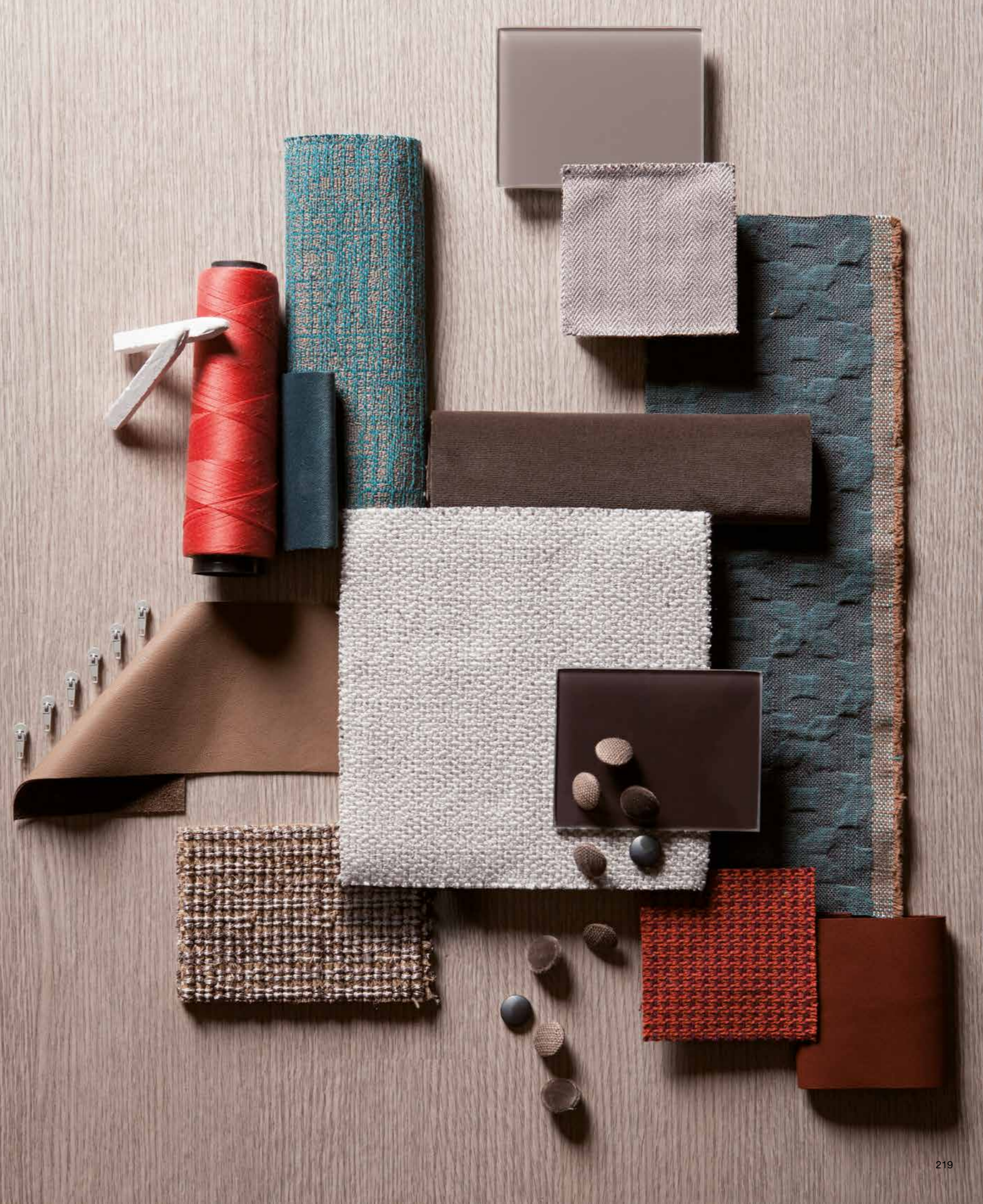

SHABBY

Piume e lini disegnano eleganti morbidezze: SHABBY è un esclusivo prodotto che fa del contrasto fra volumi pieni e soffici vuoti la sua raffinata natura.

Le particolari cuciture sartoriali delineano i volumi piacevolmente scomposti dalle soffici imbottiture. I cuscini, liberamente posizionati, giocano con forme, trame e colori esaltando l'avvolgente natura della piuma.

Divani e composizioni su misura sono dedicati a chi ama inaspettati ed eleganti abbinamenti tessili.

Feathers and linen draw an elegant softness: SHABBY is an exclusively executed product. Marked by sharp contrast between its voluptuous lines and downy cushions. Presence of tailored seams pleasantly delineates the decomposed volumes of soft padding. The cushions, while freely positioned, play along with the flowing shapes, textures and colors, highlighting the comfortable nature of feather down. Sofas and tailored-made compositions are dedicated to those who love and appreciate unexpected fabric combinations.





Turning SOFA *inside out* Materiali innovativi ed alta sartoria: ogni particolare si declina in comfort e design.

- 1** All'interno di sedute e schienali l'innovativa microfibra HI-TEX rivoluziona comfort, accoglienza e microclima del divano. HI-TEX è un prodotto duttile dall'ottima elasticità e stabilità. HI-TEX è morbido, accogliente, leggero, ignifugo, traspirante, inodore ed ecocompatibile.

The innovative HI-TEX microfiber revolutionises the comfort, support and microclimate in the seats and backrest of the sofa. HI-TEX is a ductile product having excellent elasticity and stability. HI-TEX is soft, comfortable, lightweight, fireproof, breathable, odourless and environmentally friendly.

- 2** La sartoria è fatta di ricerca e tradizione, materiali e manualità. Profili, cuciture e gros grain raccontano la cultura dell'imbottito.

The tailoring comes from extensive research into tradition, materials and craftsmanship. The culture of upholstery can be seen in the details, piping stitching and the grosgrain.

- 3** Ogni nostra componente imbottita è studiata in densità, forma ed elasticità per donare comfort e resistenza nel tempo. Selezioniamo più di 20 tipologie di poliuretani espansi diversi, che sapientemente misceliamo a quote differenziate per ogni progetto di divano.

Each of our padded components is studied in density, shape and elasticity to give comfort and resistance over time. We select over 20 different types of polyurethane foams, which are skilfully blended with different densities for each and every sofa project.

- 4** Esclusive schiume poliuretatiche di ultima generazione, come la schiuma microcellulare a cellula aperta SOFF, donano nuovi livelli di comfort e traspirabilità, mantenendo eccellenti resistenze ed elasticità.

The latest generation of exclusive polyurethane foams, such as microcellular foam with open cell "SOFF", provide new levels of comfort and breathability while maintaining excellent strength and elasticity.

- 5** Soltanto "pura oca", una sapiente miscela di piuma e piumino, la meticolosa selezione delle piume intere e non rotte, la garanzia di origine e trattamento del prodotto secondo i più alti standard e il tessuto speciale ad alta tenuta conferiscono a un cuscino l' "Etichetta ORO" ASSOPIUMA®.

Only "pure goose" feathers, a blend of feathers and down, the meticulous selection of whole, unbroken feathers, a guarantee of the origin and treatment of the product to the highest standards and the cushions' special high tensile fabric is worthy of the "Gold label" ASSOPIUMA®.

- 6** Ogni giorno testiamo ogni componente del vostro divano perché soddisfi la vostra ricerca di qualità e raffinatezza. Dai filati italiani al Velcro® originale, seguiamo le tendenze studiando le tecnologie migliori.

Every day we test each component of your sofa to ensure it satisfies your expectations of quality and sophistication. From Italian threads to the original Velcro®, we follow trends by studying the very best technology has to offer.

- 7** Sfoderabilità vuol dire creare prodotti perfetti sopra e sotto la fodera, ove ogni dettaglio sia curato e progettato per permettervi di cambiare gusti e colori qualsiasi momento vogliate. Senza pensieri, senza limiti.

Removable covers means creating perfect products on top of and under the lining, where every detail is well designed and expertly finished to allow you to change design and colourway whenever the mood takes you: limitless.

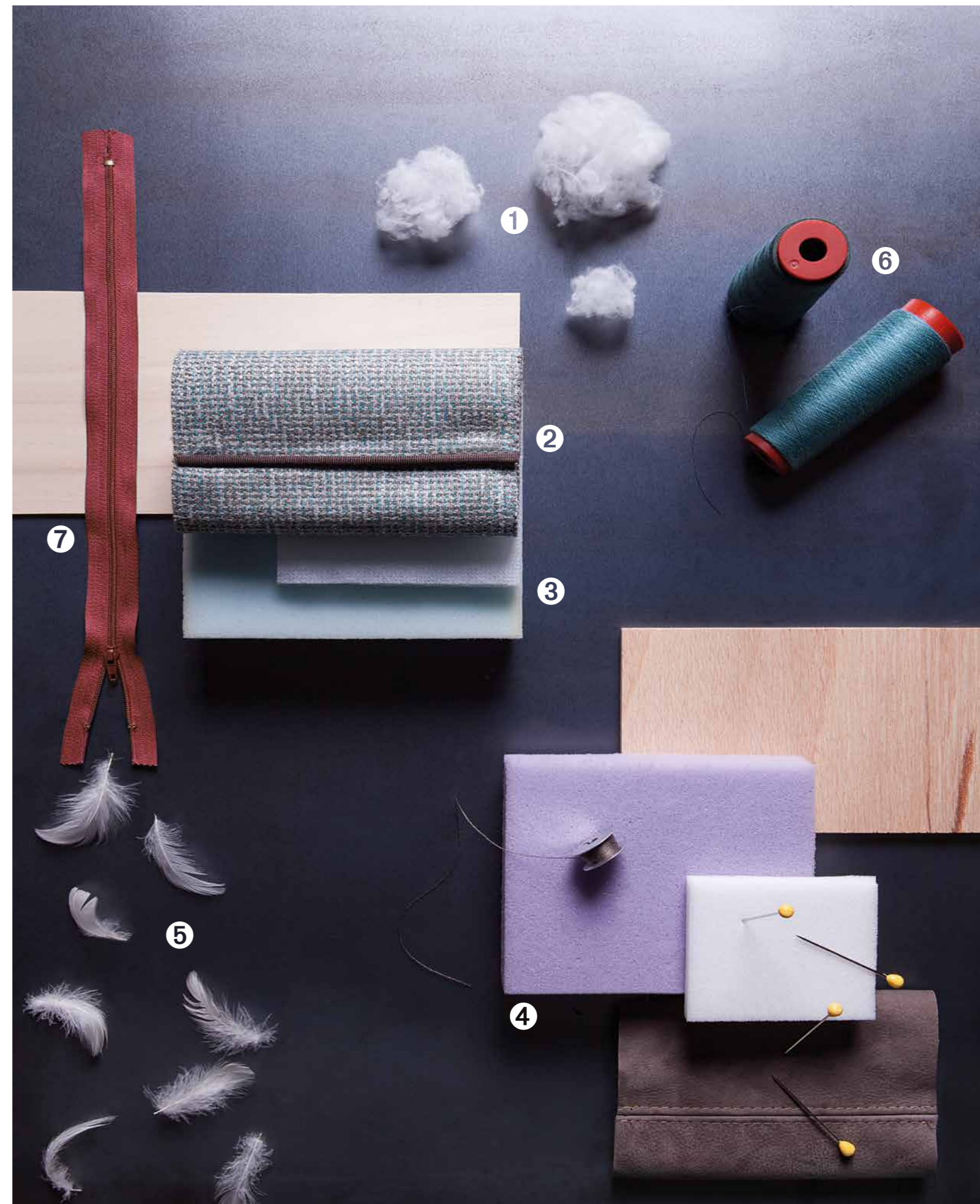

HELEN

Superfici curve e volumi fluidi si intrecciano tra loro descrivendo un progetto di poltrone versatili e dal design raffinato e contemporaneo. Il sapiente disegno delle forme nasconde una seduta accogliente in dimensioni molto contenute e permette di progettare spazi intimi e raccolti, come di impreziosire ambienti importanti.

Curved surfaces and fluid volumes entwine, describing a versatile armchair project, exuding refined and contemporary design. The skilful design of shapes conceals an enveloping and compact seat, for creating intimate and cosy spaces or embellishing important interiors.





HE68

La poltrona Helen si caratterizza per il suo sinuoso schienale a pozzetto che declina dolcemente trasformandosi in comodi braccioli.

The Helen armchair distinguishes itself in virtue of its sinuous tub back, which softly transforms into comfortable arm rests.





HE6OSB

Una poltrona senza braccioli che fa della sua grazia nelle forme estremamente contenute il proprio segno distintivo.

An armchair without arm rests, whose extremely compact shape exalts grace and distinctiveness.





I dettagli fanno la differenza

Il segno armonico e i volumi morbidi che descrivono le poltrone Helen esaltano gli abbinamenti materici e l'esperienza sartoriale di ART NOVA.

The harmonious sign and soft volumes which describe Helen armchairs exalt materials and the sartorial experience of ART NOVA.



CELINE

Un'elegante collezione di poltrone dalle forme avvolgenti.

Gli schienali dalle altezze differenziate permettono di progettare una leggera bergère e una contenuta poltrona.

Il basamento girevole in legno si adatta a un utilizzo sia domestico, che in spazi pubblici come lounge o uffici direzionali.

An elegant collection of armchairs with enveloping shapes.

The backrests with different heights allow to design a light bergère and a chair with relatively small dimensions.

The wooden swivel base fits to a domestic use as well as in public spaces such as the lounge or executive offices.



CE76HG

Celine poltrona High back girevole.
Una leggera bergère per attimi di relax.

*Celine High Back armchair with swivel base.
A light bergère for relaxing moments*





CE76LG
Celine poltrona Low Back
con basamento girevole tinto wengée.

*Celine Low Back armchair with
Wengé colour swivel base.*



CE76HG
Celine poltrona High Back
con basamento girevole tinto rovere.

*Celine High Back armchair with
oak colour swivel base.*



CE76LG
Celine poltrona Low Back
con basamento girevole tinto rovere

*Celine Low Back armchair with
oak colour swivel base.*



CE63

Celine poltroncina dining
con gambe laccate smokey grey.
Un elegante poltroncina ideale per
affiancare esclusivi tavoli da pranzo
o intimi angoli scrivania.

*Celine dining armchair with
smokey grey lacquered legs.
An elegant armchair ideal for
matching with exclusive dining
tables or intimate desk corners.*





TULIP

Un elegante guscio che
accoglie e protegge le spalle.
Un'ampia e confortevole seduta.
Volumi leggeri e scenografici al
contempo descrivono una poltrona
raffinata e prestigiosa.
Il basamento girevole in legno racconta
qualità e tecnologia del design.

*Tulip is an exclusively elegant shell
armchair, offering an utter sense of
comfort and protection.*

*Inviting, light and scenographic volumes
are the distinctive features of this refined
and prestigious structure. Wooden swivel
base highlights the quality and technology
of the design.*





TU
Poltrona TULIP
con basamento girevole tinto wengèe.

*TULIP armchair
with Wengé colour swivel base.*



LOVE CHAIR

Forme essenziali e raffinate per una poltrona che accoglie anche più di un ospite. Morbidi cuscini abbracciano il corpo e sottolineano la linea curva della struttura. LOVE CHAIR è disponibile in tre diverse misure di diametro e completabile con un pouf dedicato.

Essential and refined shapes define this armchair that accommodates more than one guest.

Soft cushions hug the body and enhance the curvy structure. LOVE CHAIR is available in three different sizes and accompanied with its own ottomans.





LVL
Poltrona LOVE CHAIR L

LV63P
Pouff LOVE da 63 cm





LVXL
Chaise-longue LOVE CHAIR XL





GENTLEMAN

Una bergère che richiama il comfort del passato ma mostra un nuovo design leggero ed esclusivo.

Linee sinuose invogliano a sedersi e delimitano uno spazio raccolto e privato.

L'alto schienale e un comodo pouf consentono il relax in ogni situazione.

I dettagli e le finiture raccontano sartorialità e innovazione.

The Bergère evokes the comfort of a vintage armchair, but it shows a light and exclusive design. Sinuous lines attract to sit down and define a cozy and private space.

The high backrest and a comfortable ottoman allow you to relax at any given time.

The details and the finishings describe a sartorial craftsmanship.



Exploded view *of quality* *Qualità, tecnologie e materiali per durare nel tempo*

- 1** Vero legno, massello e multistrato delle migliori essenze europee compone il pianale dei nostri divani. Le certificazioni FSC e classe E1 ed E0 dei nostri legni e multistrati garantiscono una gestione forestale responsabile ed i requisiti ambientali delle normative internazionali più rigorose.

Real wood, solid wood and plywood, our sofa frames are made from the best European species. FSC and E1 - E0 class certification for our wood and plywood guarantee responsible forest management and that environmental requirements of the most stringent international regulations are met.

- 2** Ogni componente dei nostri prodotti è progettata grazie ai più innovativi software CAD. Ogni struttura ed ogni imbottitura è lavorata o pesata con macchinari a controllo numerico in modo da garantire la più accurata precisione di ogni prodotto.

Every one of our product components is designed using the most innovative CAD software. The structure and padding is processed or weighed using numerically controlled machines in order to ensure each product is precisely accurate.

- 3** Piedi e basamenti sono studiati e prodotti nel distretto industriale della Brianza: dalle pressofusioni e verniciature alle lavorazioni del legno massello: tutto per garantire un sostegno che dura nel tempo.

The bases and feet are designed and produced in the Brianza industrial area: from the castings and coatings to the solid wood production; ensuring continued support over time.

- 4** I nostri divani utilizzano piani di molleggio realizzati con cinghie elastiche monodirezionali di nuova generazione ad alta componente di caucciù che donano un comfort particolarmente omogeneo e duraturo.

Our sofas suspension plans with new generation unidirectional elastic belts with high rubber content which provide exceptionally smooth, lasting comfort.

- 5** La continua ricerca del dettaglio si esprime anche nei più piccoli componenti: la scelta della migliore ferramenta delle officine del territorio esprime la qualità del made in Italy.

The continuous pursuit of detail is also used in the smallest components: choosing the very best hardware confirms the very best of 'Made in Italy' quality.

- 6** Ogni lavorazione viene eseguita e controllata in Italia: dalla produzione degli stampi alla miscela delle piume con i massimi standard di precisione e qualità.

Every product process is carried out and controlled in Italy: from the production of the moulds to the mixture of feathers, all with the highest precision and quality standards.

- 7** Sappiamo far convivere legno e metallo nelle nostre strutture, sapientemente miscelati, per dare resistenza e flessibilità insieme.

Our strength is understanding how to make wood and metal coexist in our products, expertly blending them to provide strength and flexibility.

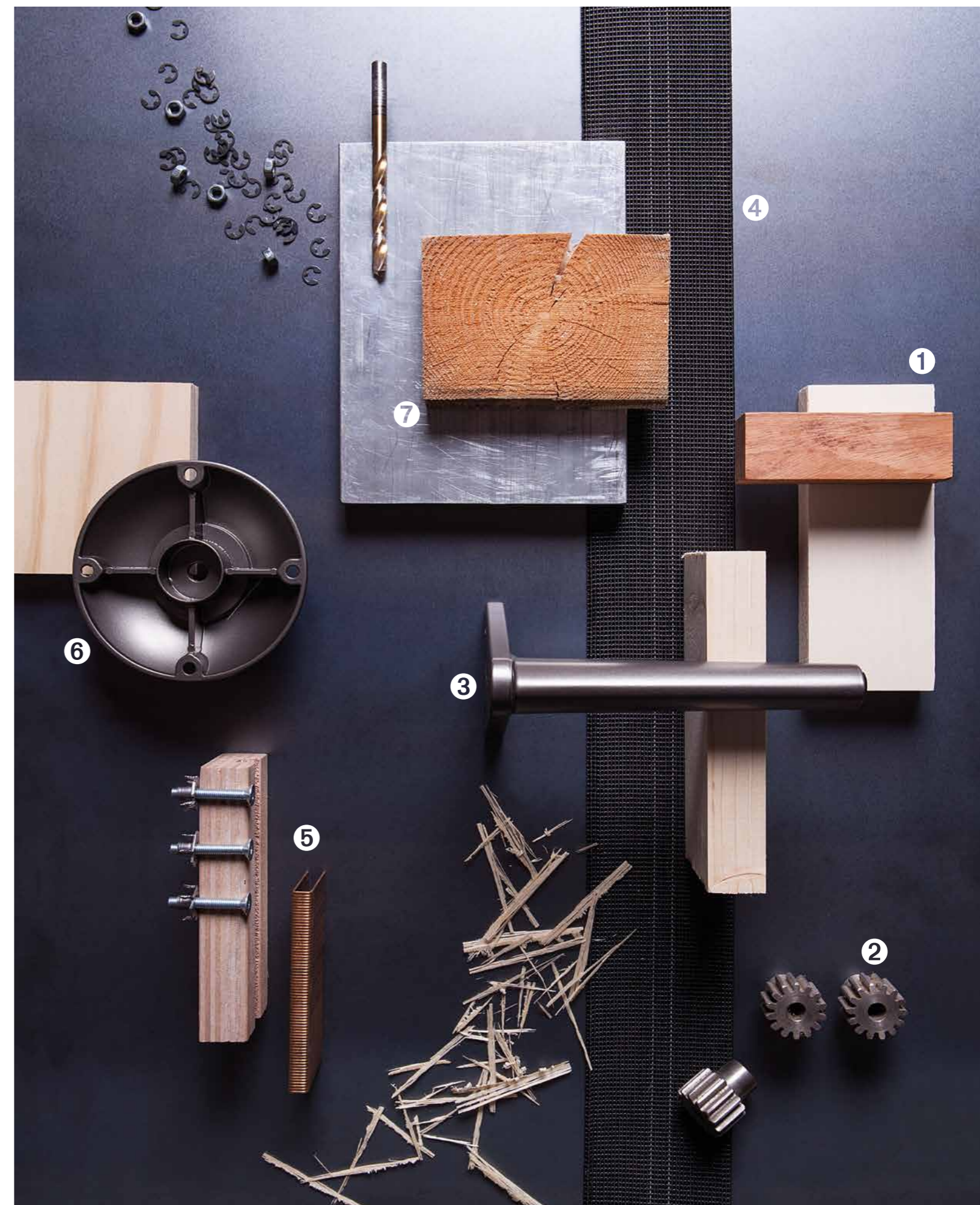



INDY

La raffinatezza delle sapienti lavorazioni del legno fanno da cornice a volumi tessili scenografici ma non invadenti. Una grande testata con "ali" che abbracciano i momenti di relax si contrappone ad una base aerea e sospesa per donare leggerezza. Legno e tessuto trovano la loro sintonia in un letto inaspettatamente sfoderabile.

Refined wood frames enclose spectacular textile volumes.

A large headboard with "wings" which embrace moments of relax, sets against a suspended base to enhance the lightness of decor.

Wood and fabric find their syntony in a bed unexpectedly with removable covers.



INDY si compone di un sistema di testate e basi che lo rendono inseribile anche in ambienti meno ampi. Testate larghe o strette, basi in legno e tessuto o totalmente imbottite con contenitore, possono combinarsi tra loro per realizzare il letto ideale.

INDY is composed by a system of specifically designed headboards and bases, facilitating interior design in every kind of space.

Wide or narrow headboards, bases made in wood and fabric, or totally upholstered with container, blend to realize your ultimate model of bed.



Letto con testata stretta e base sospesa in legno.
Indy bed with 204 cm headboard and suspended wood base.



Letto con testata larga e base sospesa in legno.
Indy bed with wide headboard and suspended wood base.





INDY Tailor

La raffinatezza delle sapienti lavorazioni del legno fanno da cornice a volumi tessili scenografici ma non invadenti. Una grande testata con "ali" che abbracciano i momenti di relax si abbina ad una morbida e raffinata base tessile.

The refinement of skillfully crafted wood frames scenographic yet never overwhelming fabric volumes. A large headboard with "wings" embraces moments of relaxation, matched with a soft and refined textile base.





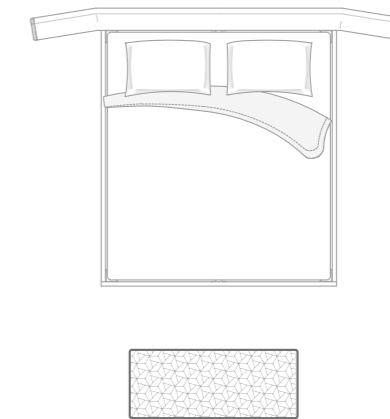

Complementi e panche arricchiscono di spunti progettuali e decorativi un ambiente dal gusto contemporaneo.

Accessories and benches complete project and decorative elements, to furnish a contemporary interior.





Invisible removable cover *system*

Sfoderabilità invisibile

Legno e tessuto trovano
la loro sintonia in un letto
inaspettatamente sfoderabile.
Qualunque sia il rivestimento,
un sistema a innesto rapido
permette di separare i
componenti di legno e svestire
semplicemente il letto.

*Wood and fabric are
masterfully combined in this
bed with removable covers.*





ISLAND BED

Il letto cambia la sua tradizionale immagine trasformandosi in un'isola che integra materasso ed elementi funzionali, liberamente posizionabili. ISLAND BED aumenta lo spazio di vivibilità senza ingombrare le tradizionali dimensioni della camera.

The bed changes its traditional image turning into an island that includes mattress and functional elements, that can be freely replaced. ISLAND BED increases the living space, without overloading the traditional room.







BOLD

Un grande cuscino descrive e rappresenta la testata morbida ed avvolgente, studiata per appoggiare la testa in ogni situazione di utilizzo del letto.

Il tessuto cade libero, arricchito da cuciture esclusive che ne esaltano la natura shabby chic. Il piano del letto è alto, comodo e può nascondere, a scelta, un contenitore.

A "big pillow" describes the soft and embracing headboard, designed to place the head.

The falling fabric, enriched by its exclusive stitchings, highlight the shabby-chic character.

The bed base is high, comfortable and it may hide an optional storage.





info and size

BYRON	280
COSY	290
GLAM	298
FILIPH AIR	304
CLOUD	310
FILIPH	316
FILIPH OUTDOOR	324
OLTRE	326
SQUARE LINE VENTICINQUE/VENTI	328
BLUM	340
WILL	346
SHABBY	352
FLARE Tables	356
GLAM Tables	357
DYNAMIC	358
FILIPH Tables	359
CLOUD Tables	359
CELINE	360
LOVE CHAIR	361
HELEN	362
GENTLEMAN	363
TULIP	363
INDY TAILOR	364
INDY	368
ISLAND BED	370
BOLD	372

Dimensioni e misure sono espresse in centimetri. Variazioni di dimensioni nell'ordine del +/- 2% sono da considerarsi tollerabili.
ART NOVA si riserva il diritto di modificare prodotti ed elementi in questo catalogo, senza ulteriore preavviso.

*All dimensions and sizes are in centimeter. Dimensional variations of +/- 2% are possible.
ART NOVA reserves the right to modify the products and the components in this catalogue, without any prior notice.*

Struttura portante: in legno massello e multistrato monoscocca con inserti strutturali in acciaio, molleggio garantito da cinghie elastiche ad alta componente di caucciù.

Preparazione della struttura: in poliuretano espanso a quote differenziate ad alta densità e resilienza. Ulteriore rivestimento della struttura con fibra di poliestere termolegata di forte spessore, accoppiata con vellutino.

Cuscinatura: imbottitura cuscino di seduta in poliuretano espanso a densità differenziate. Layer superiore di seduta in poliuretano espanso speciale ad alta traspirabilità MEMOSOFF. Rivestimento in ovatta di poliestere siliconata ad alto spessore, accoppiata con tela di cotone bianca. In alternativa, su richiesta: imbottitura cuscino in "Memofill" canalizzato (particelle di poliuretano viscoelastico termosensibile e innovativa microfibr "Hi-tex") con inserto centrale in poliuretano ad alta resilienza. Ulteriore rivestimento del cuscino con fibra di poliestere termolegata accoppiata con tela di cotone bianca.

Cuscini schienale: in piuma d'oca canalizzata certificata "Assopiuma etichetta Oro".

Cuscini ornamentali: in piuma d'oca canalizzata certificata "Assopiuma".

Sfoderabilità: rivestimento sfoderabile nella versione in tessuto, fisso nella versione in pelle. La sfoderabilità della base è attuabile previo smontaggio dle basamento. I poggiatesta e le strutture metalliche dei braccioli sono fisse. Cuscini seduta, rullo bracciolo e schienale sempre sfoderabili.

Basamenti: piedi a disegno speciale in metallo pressofuso e tubolare di cornice in alluminio estruso, disponibile nelle versioni: Peltro, Alluminio spazzolato lucido, Nichel nero con tubolare rivestito in pelle.

Poggiatesta opzionali: schienalini indipendenti e spostabili in acciaio rivestito in pelle o in Tecnonabuk, disponibili nei colori in collezione.

Braccioli opzionali: braccioli indipendenti e spostabili in acciaio rivestito in pelle o in Tecnonabuk, disponibili nei colori in collezione. Rullo staccabile con imbottitura in poliuretano espanso e rivestimento in ovatta di poliestere siliconata ad alto spessore, accoppiata con vellutino.

Finiture basamento
Metal base finish

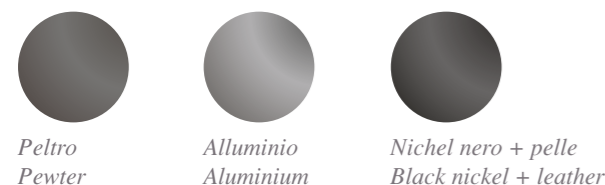

Structure: in solid wood and plywood, monocoque, with steel reinforcements. High natural rubber content elastic strap webbing.

Preparation of the seat: in high resilience variable-density polyurethane foam. Out covering with heat-bonded polyester fiber laminated to technical fiber.

Seat cushion: in high resilience variable-density polyurethane foam with MEMOSOFF (breathable polyurethane foam), covered with a high depth polyester silicon fiber heat-bonded to white cotton canvas.

In alternative, on request: "Memofill" quilt (heat-sensitive foam and innovative microfiber "Hi-tex" mixed) with high resilience polyurethane foam central insert with out covering with heat-bonded polyester fiber laminated to cotton.

Backrest cushions: channeled goose down, certified "Assopiuma", gold label.

Ornamental cushion: channeled goose down, certified "Assopiuma".

Covers: are completely removable in fabric version and fixed in leather version. The structure fabric cover is removable only after the metal base disassembling. Movable armrest and headrest are always fixed. Seat cushion, armrest bolster and backrest cushion covers are completely removable.

Base: special design die-cast metal feet and aluminium extruded tubular frame, available in these finishes: painted Peltro, Polished brushed aluminum or black Nichel feet with leather covered tubular frame.

Optional headrest: movable metal backrest covered with leather or Tecnonabuk as available colors.

Optional armrest: movable metal armrest covered with leather or Tecnonabuk as available colors. Bolster (removable) in high resilience polyurethane foam, covered with a polyester silicon fiber heat-bonded

BYRON

Dimensioni e altezze di seduta con base profondità 102 cm
Sitting depth and hight with base 102 cm

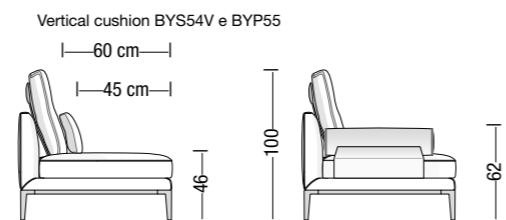
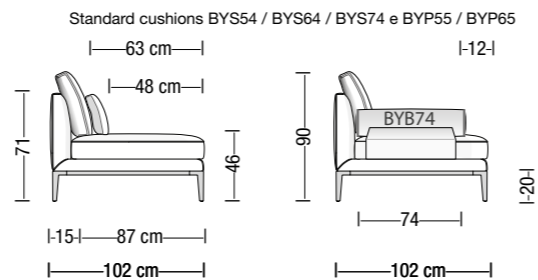

Dimensioni e altezze di seduta con base profondità 92 cm
Sitting depth and hight with base 92 cm

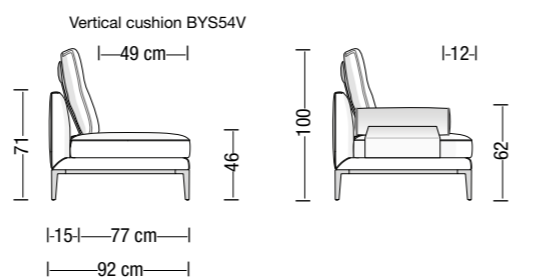
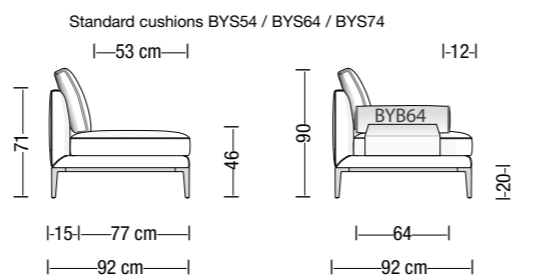

Divani con braccioli a rullo, profondità 92 cm
Sofas with roll armrests, 92 cm depth

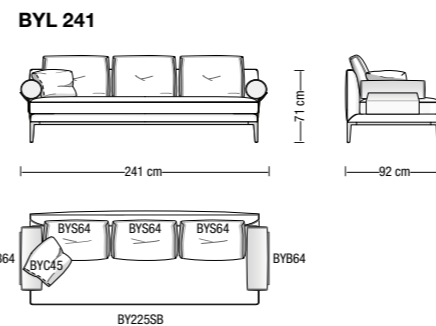
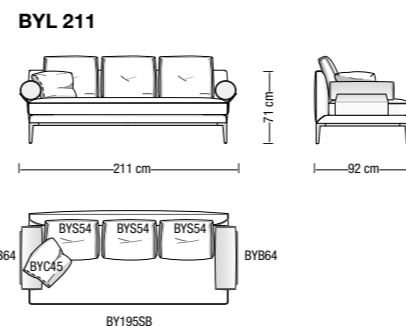
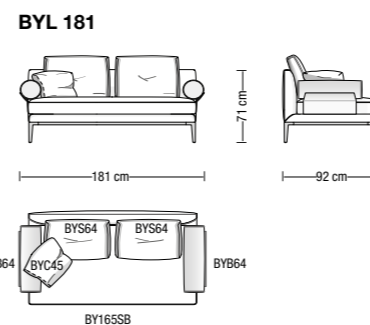

Disposizione alternativa schienali
Alternative backrest cushions layout

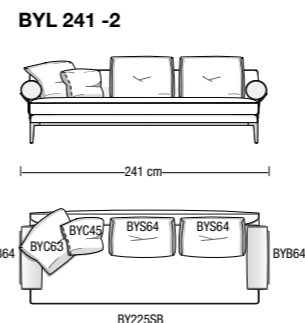

Divani con 1 bracciolo a rullo, profondità 92 cm
Sofas with 1 roll armrest, 92 cm depth

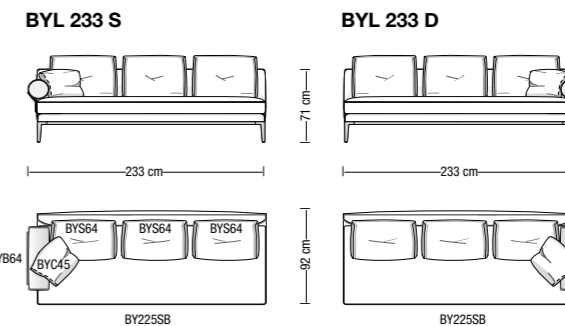
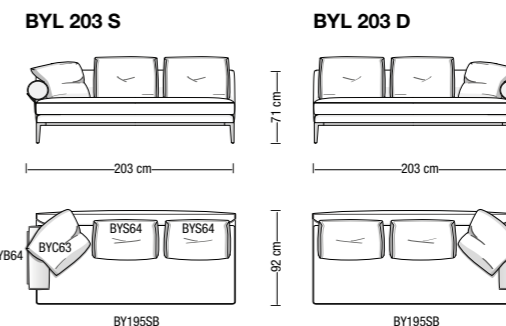
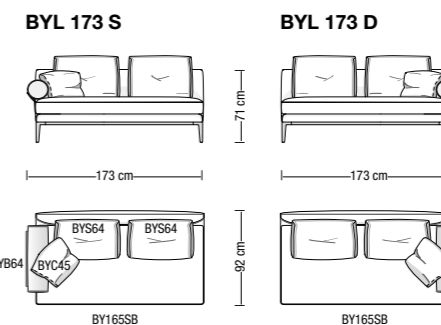

Elementi centrali, profondità 92 cm
Central elements, 92 cm depth

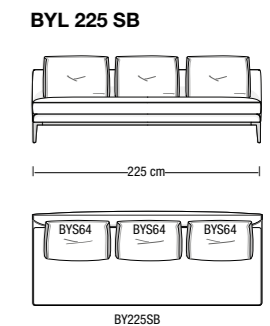
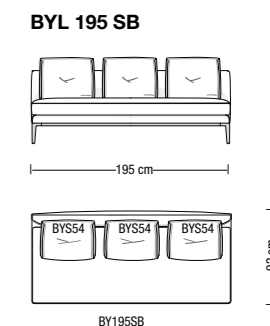
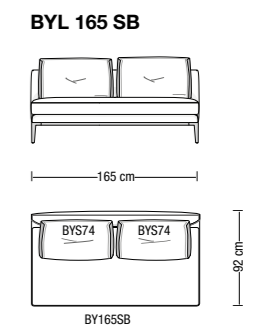

Divani con braccioli, profondità 92 cm
Sofas with armrests, 92 cm depth

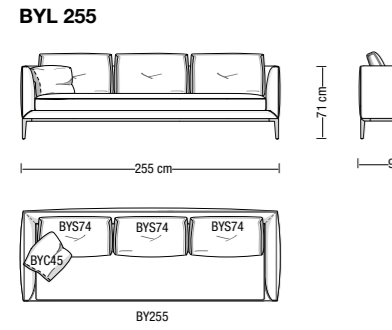
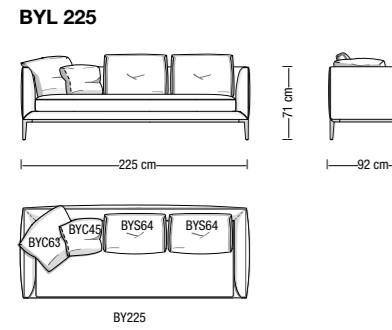
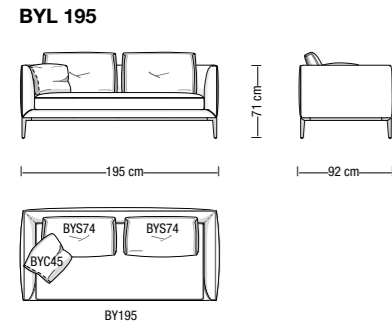

Disposizione alternativa schienali
Alternative backrest cushions layout

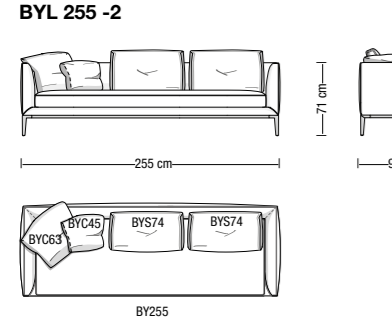

Divani con 1 bracciolo, profondità 92 cm
Sofas with 1 armrest, 92 cm depth

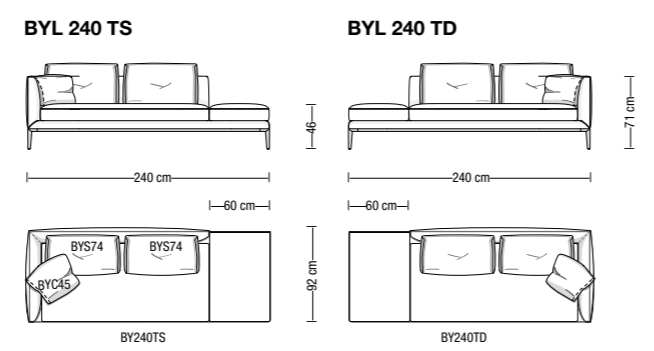
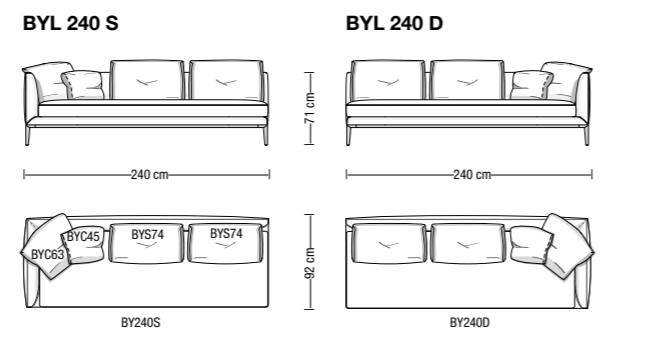
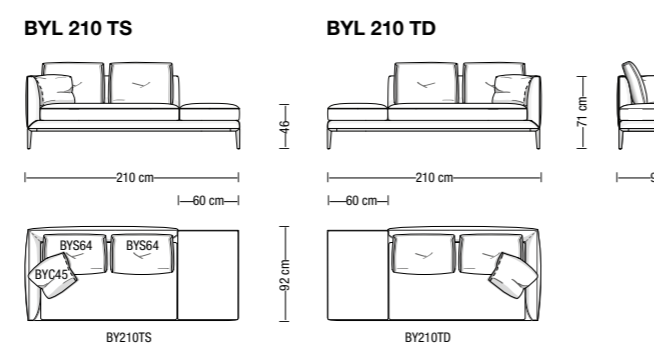
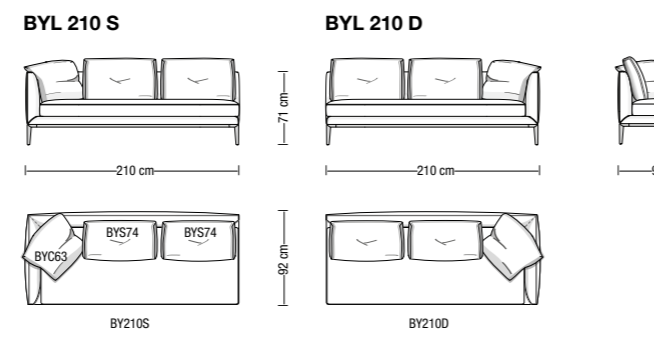
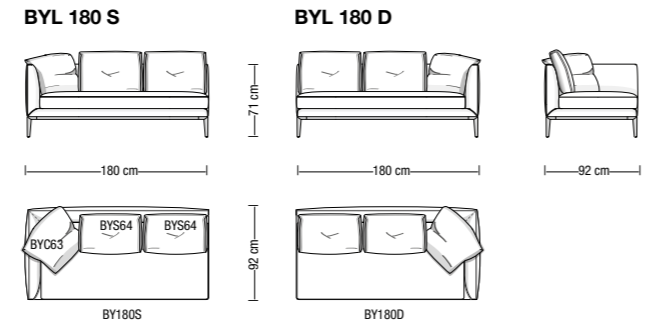

Terminali / angolari, profondità 92 cm
Terminal corner elements, 92 cm depth

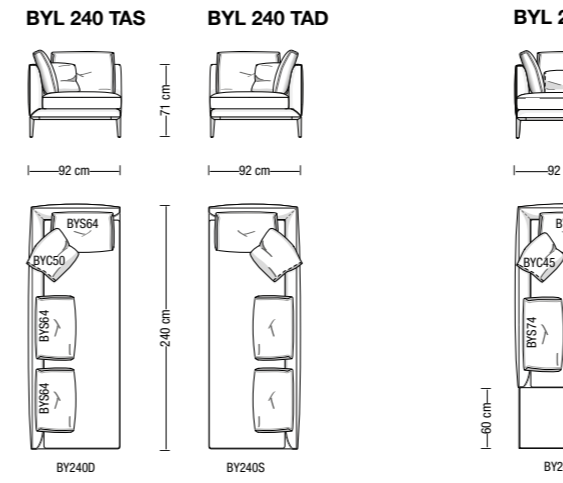
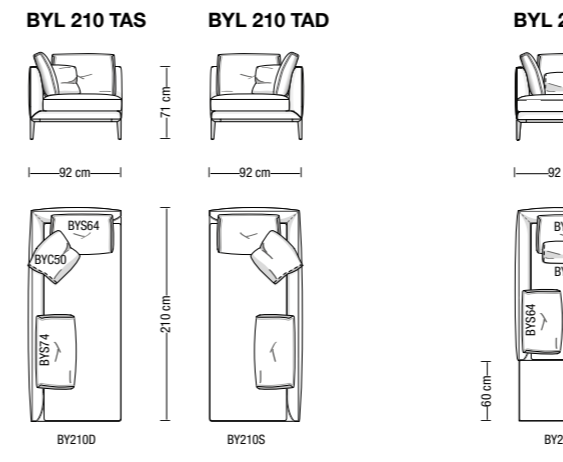
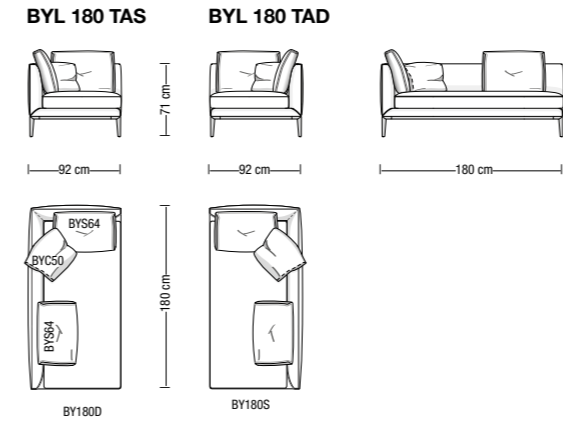

Terminali con penisola, profondità 92 cm
Open-end terminal elements, 92 cm depth

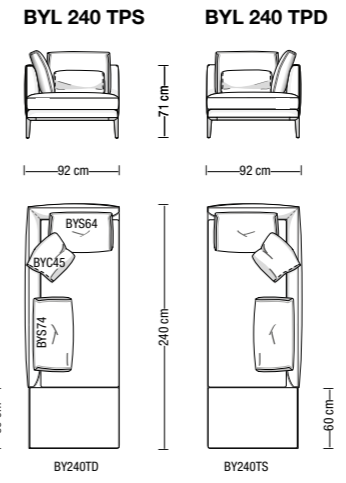
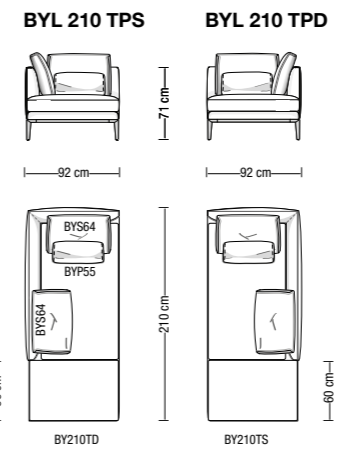

Terminali / angolari, profondità 92 cm
Terminal corner elements, 92 cm depth

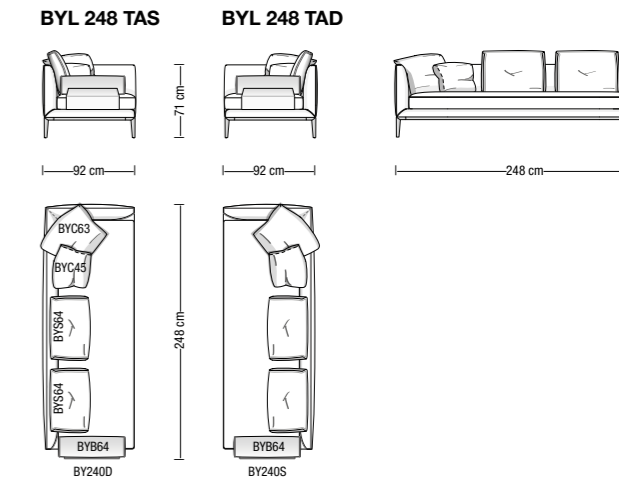
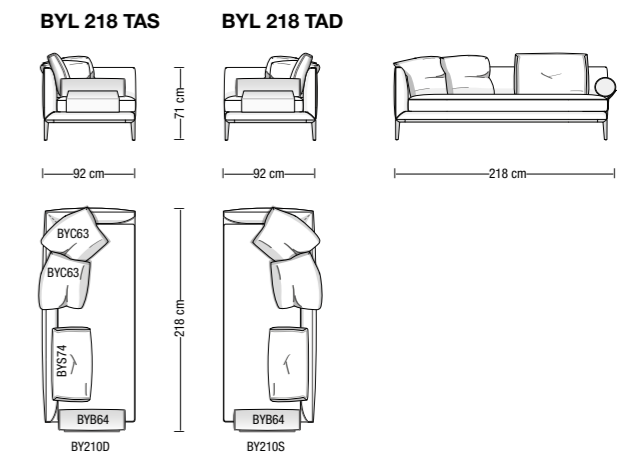
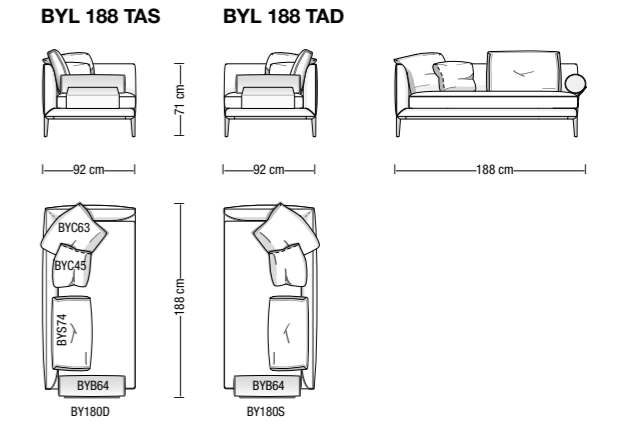

Chaise-longues
Chaise-longue

BYL 100X160 CLS **BYL 100X160 CLD**

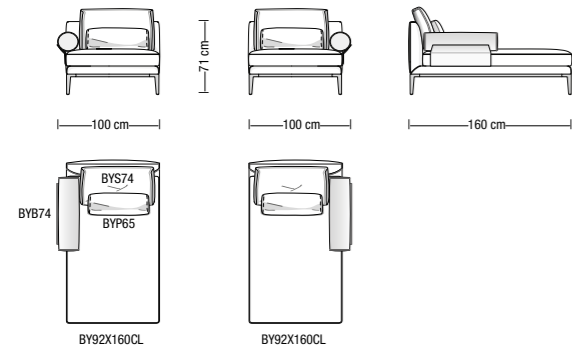

BYL 128X160 CLS **BYL 128X160 CLD**

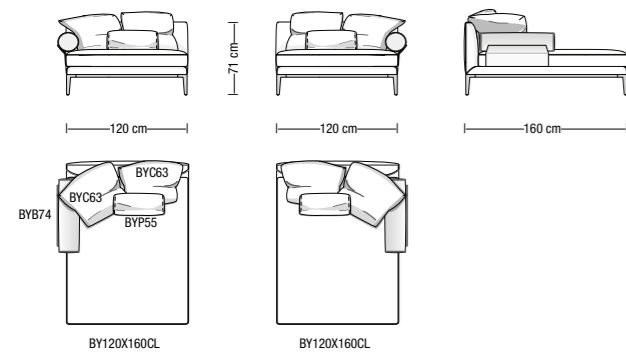

Pouf
Ottoman

BY 92X72 P

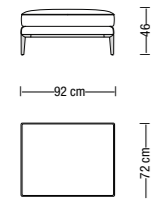

BY 92X92 P

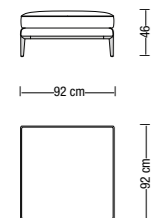

BY 165X92 P

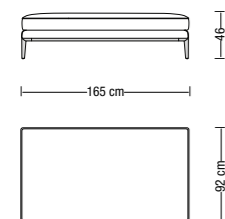

BY 58X48 P

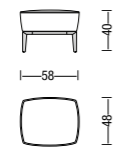

Braccioli mobili con rullo
Movable armrests with bolster

BYB 74

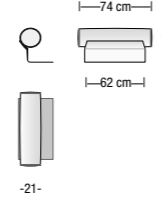

BYB 64

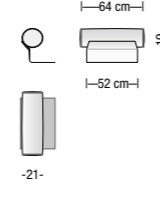

L'inserimento dei braccioli mobili nelle basi divano, aumenta la larghezza di 8 cm
Addition of movable armrests in sofa bases increases the width by 8 cm

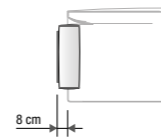

Cuscinerie
Cushions

BYS 54

Schienale da 54 cm
Backrest cushion 54 cm

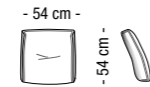

BYC 45

Cuscino 45x45 in piuma
Cushion 45x45 feather

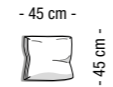

BYS 64

Schienale da 64 cm
Backrest cushion 64 cm



BYC 50

Cuscino 50x50 in piuma
Cushion 50x50 feather



BYS 74

Schienale da 74 cm
Backrest cushion 74 cm



BYC 63

Cuscino 63x63 in piuma
Cushion 63x63 feather



BYS 54V

Schienale verticale da 54 cm
Vertical backrest cushion 54 cm

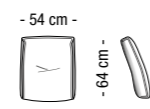

Da utilizzare in abbinata a BYSUP
To be used in combination with BYSUP

BYSUP

Schienale di supporto in metallo e pelle
Leather and steel backrest

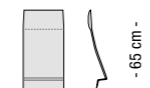

- 37 cm -

Da utilizzare in abbinata a BYS54V
To be used in combination with BYS54V

BYP 55

Poggiareni da 55 cm
lumbar rest 55 cm

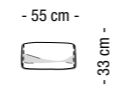

BYP 65

Poggiareni da 65 cm
lumbar rest 65 cm



Divani con braccioli a rullo, profondità 102 cm
Sofas with roll armrests, 102 cm depth

BYL 181 X

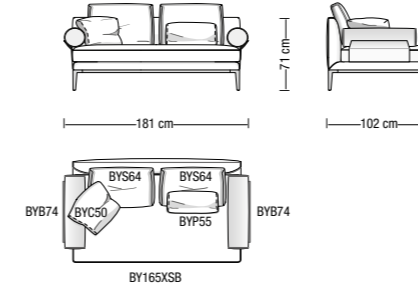

BYL 211 X

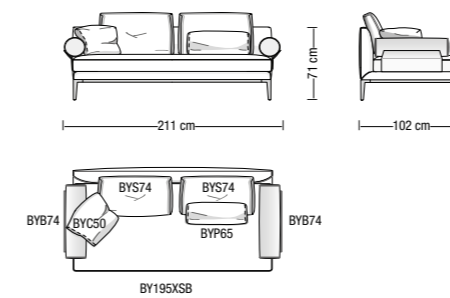

BYL 241 X

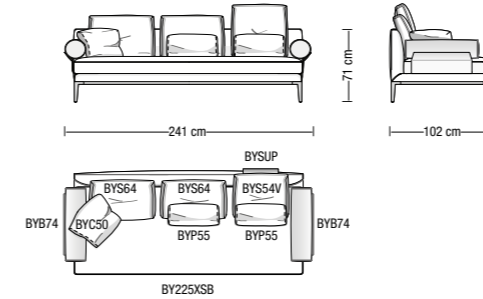

Disposizione alternativa schienali
Alternative backrest cushions layout

BYL 241 X -2

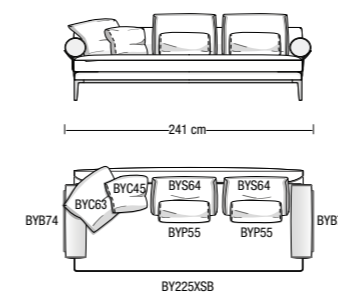

Divani con 1 bracciolo a rullo, profondità 102 cm
Sofas with 1 roll armrest, 102 cm depth

BYL 173 X S

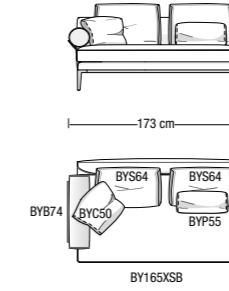

BYL 173 X D

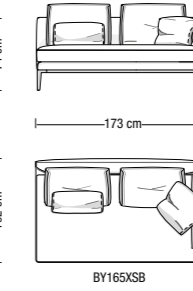

BYL 203 X S

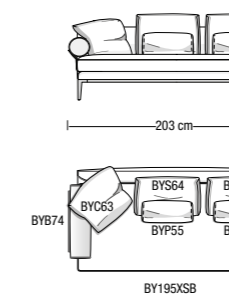

BYL 203 X D

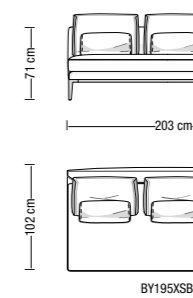

BYL 233 X S

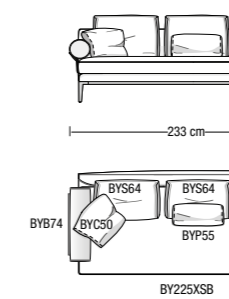

BYL 233 X D

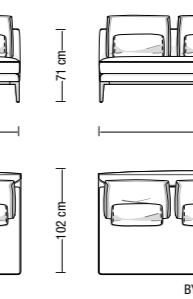

Divani centrali, profondità 102 cm
Central elements, 102 cm depth

BYL 165 X SB

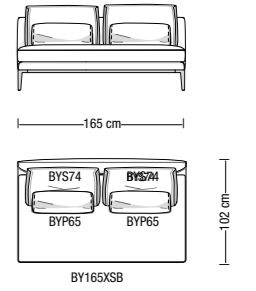

BYL 195 X SB

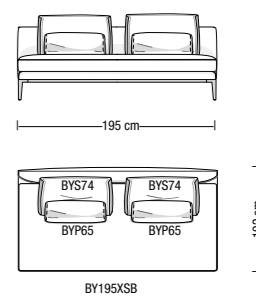

BYL 225 X SB

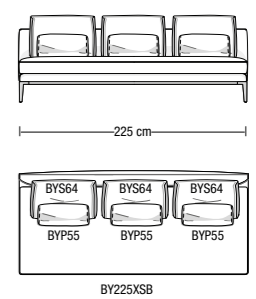

Divani con braccioli, profondità 102 cm
Sofas with armrests, 102 cm depth

BYL 195 X

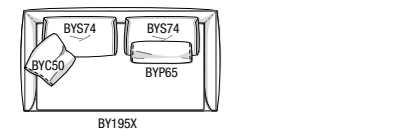
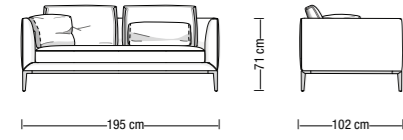

BYL 225 X

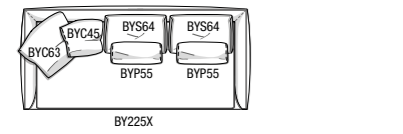
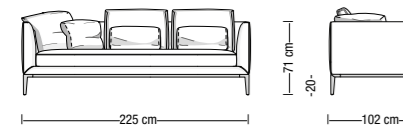

BYL 255 X

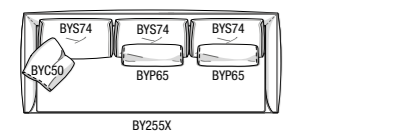
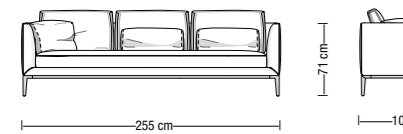

Disposizione alternativa schienali
Alternative backrest cushions layout

BYL 255 X -2

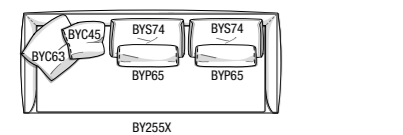
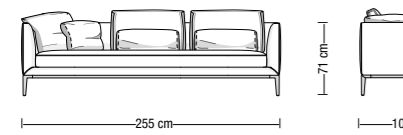

Divani con 1 bracciolo, profondità 102 cm
Sofas with 1 armrest, 102 cm depth

BYL 180 X S

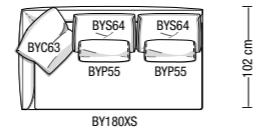
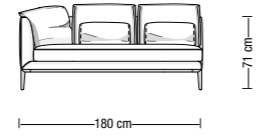

BYL 180 X D

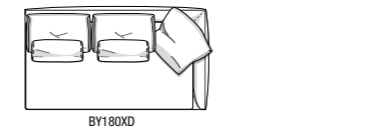
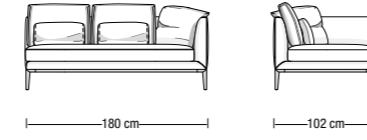

BYL 210 X S

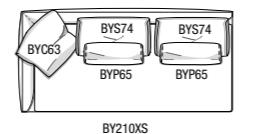
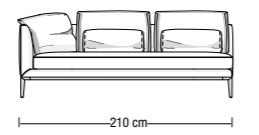

BYL 210 X D

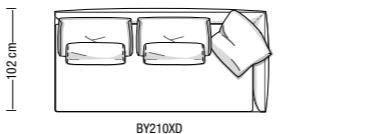
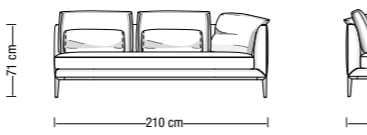

BYL 210 X TS

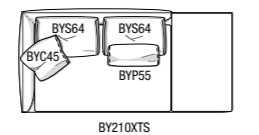
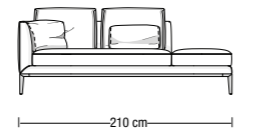

BYL 210 X TD

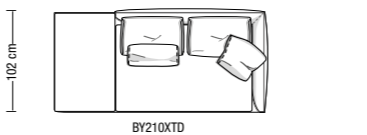
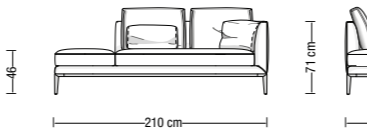

BYL 240 X S

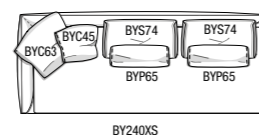
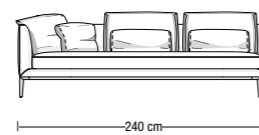

BYL 240 X D

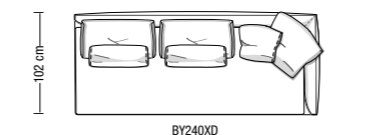
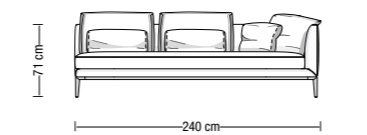

BYL 240 X TS

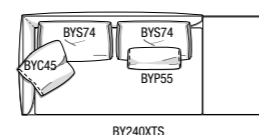
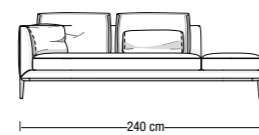

BYL 240 X TD

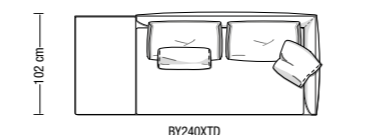
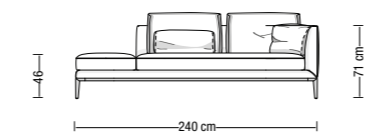

Terminali / angolari, profondità 102 cm
Terminal corner elements, 102 cm depth

BYL 180 X TAS

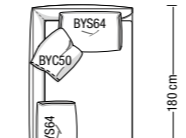
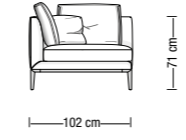

BYL180XTAD

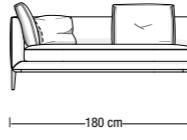
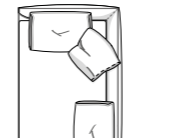
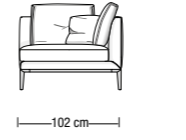

BYL 210 X TAS

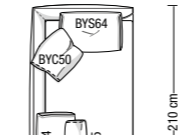
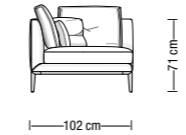

BYL 210 X TAD

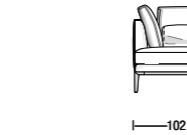
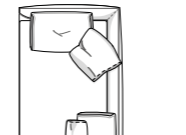
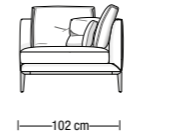

Terminali con penisola, profondità 102 cm
Open-end terminal elements, 102 cm depth

BYL 210 X TPS

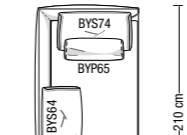
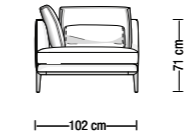

BYL 210 X TPD

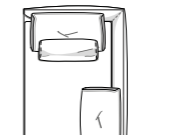
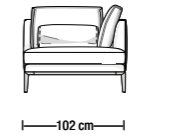

Terminali / angolari, profondità 102 cm
Terminal corner elements, 102 cm depth

BYL 188 X TAS

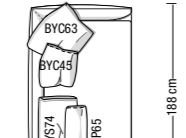
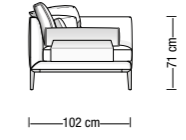

BYL 188 X TAD

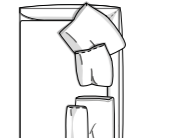
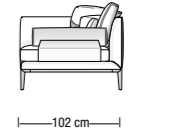

BYL 218 X TAS

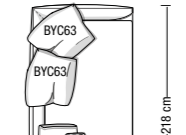
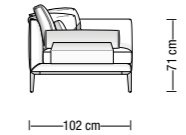

BYL 218 X TAD

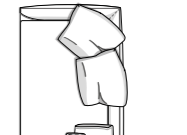
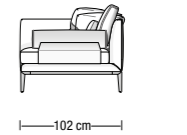

BYL 240 X TAS

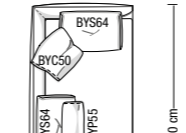
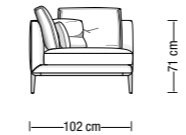

BYL 240 X TAD

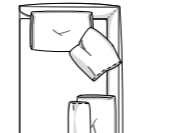
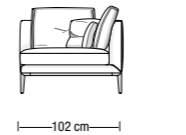

BYL 240 X TPS

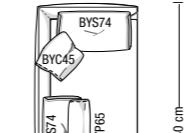
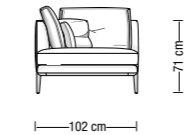

BYL 240 X TPD

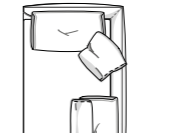
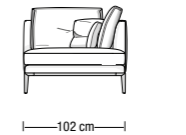

BYL 248 X TAS

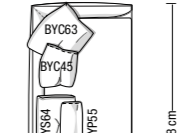
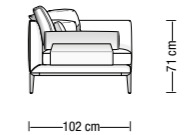

BYL 248 X TAD

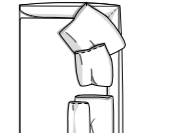
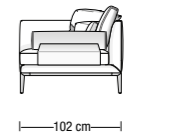

Chaise-longues
Chaise-longue

BYL 100X160 CLS **BYL 100X160 CLD**

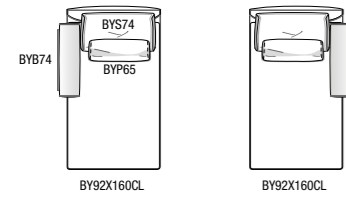
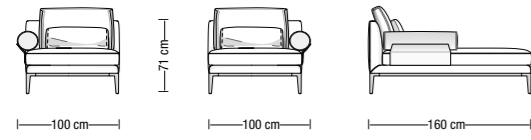

BYL 128X160 CLS **BYL 128X160 CLD**

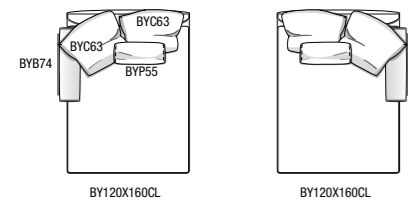
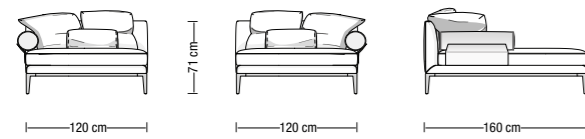

Pouf
Ottoman

BY 92X72 P

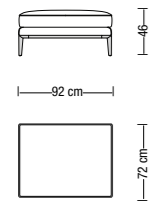

BY 58X48 P

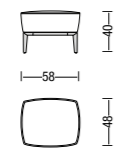

BY 92X92 P

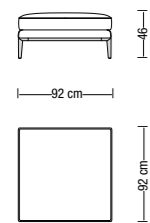

BY 165X92 P

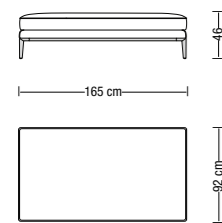

Braccioli mobili con rullo
Movable armrests with bolster

BYB 74

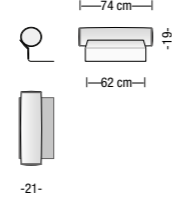

BYB 64

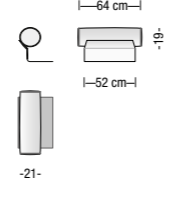

L'inserimento dei braccioli mobili nelle basi divano, aumenta la larghezza di 8 cm
Addition of movable armrests in sofa bases increases the width by 8 cm

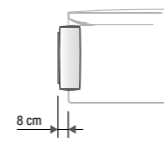

Cuscinerie
Cushions

BYS 54

Schienale da 54 cm
Backrest cushion 54 cm

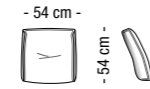

BYC 45

Cuscino 45x45 in piuma
Cushion 45x45 feather

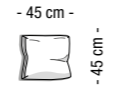

BYS 64

Schienale da 64 cm
Backrest cushion 64 cm

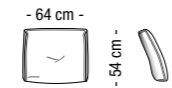

BYC 50

Cuscino 50x50 in piuma
Cushion 50x50 feather

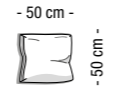

BYS 74

Schienale da 74 cm
Backrest cushion 74 cm

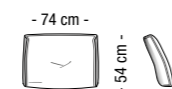

BYC 63

Cuscino 63x63 in piuma
Cushion 63x63 feather



BYS 54V

Schienale verticale da 54 cm
Vertical backrest cushion 54 cm



Da utilizzare in abbinata a BYSUP
To be used in combination with BYSUP

BYSUP

Schienale di supporto in metallo e pelle
Leather and steel backrest

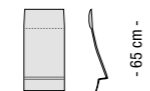

- 37 cm -

Da utilizzare in abbinata a BYSS4V
To be used in combination with BYSS4V

BYP 55

Poggiareni da 55 cm
lumbar rest 55 cm

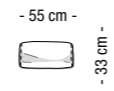

BYP 65

Poggiareni da 65 cm
lumbar rest 65 cm



Composizioni suggerite
Suggested Compositions

BY 1

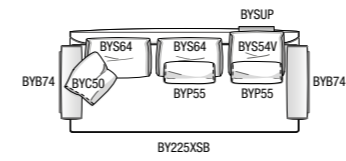
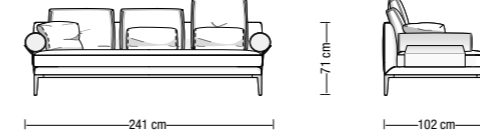

BY 3

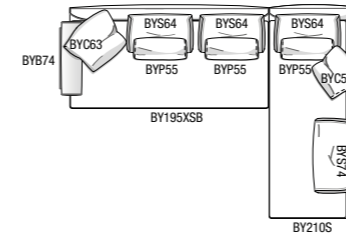
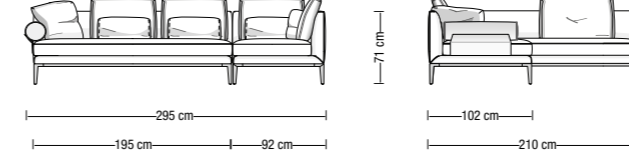

BY 5

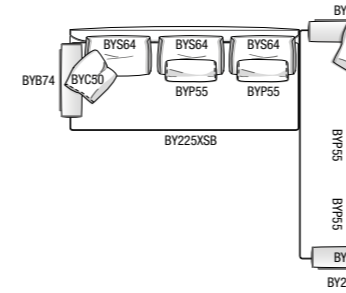
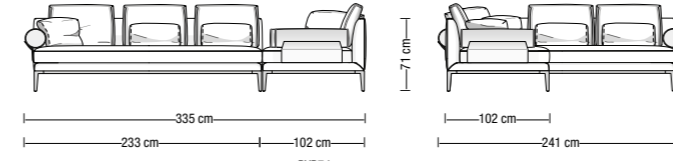

BY 2

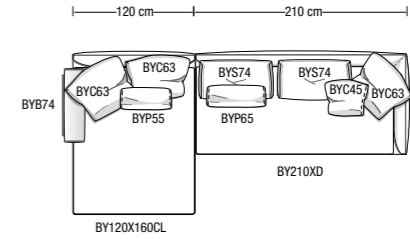
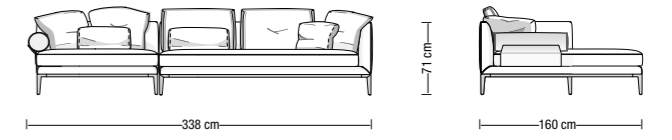

BY 4

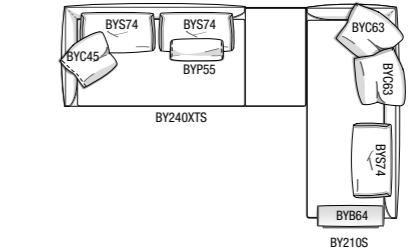
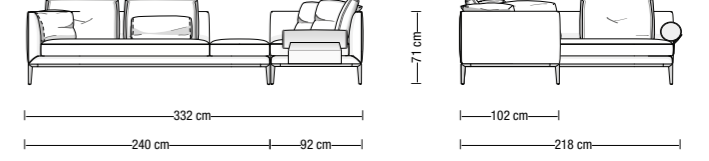

BY 6

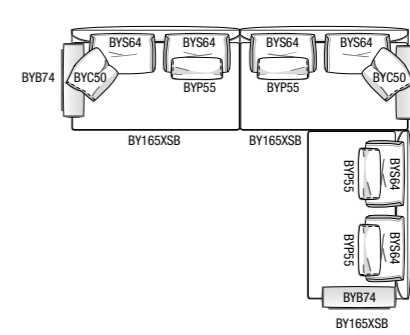
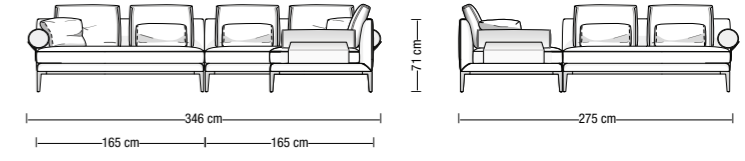

Struttura portante: in acciaio e legno multistrato. Dotato di sistema a binario per il fissaggio degli schienali.

Preparazione della struttura di seduta: in poliuretano espanso a quote differenziate ad alta densità e resilienza. Layer superiore di seduta in poliuretano espanso speciale ad alta traspirabilità MEMOSOFF e microfibra "Hi-tex": imbottitura di ultima generazione ad alto fattore di comfort, certificata OEKOTEX STANDARD 100, ignifuga, ecocompatibile, 100% riciclabile.

Schienali: struttura in acciaio con molleggio garantito da cinghie elastiche ad alta componente di caucciù. Imbottitura della struttura in poliuretano espanso a quote differenziate. Ulteriore rivestimento della struttura con fibra di poliestere termolegata di forte spessore, termolegata con cotone. Gli schienali sono dotati di un sistema di aggancio flessibile alla struttura delle basi.

Cuscini schienale: totalmente imbottiti in microfibra "Hi-tex" canalizzata, di ultima generazione. Cuscini schienali poggiatesta con inserto ergonomico in poliuretano espanso sagomato a controllo numerico.

Sfoderabilità: rivestimento sfoderabile nella versione in tessuto e pelle.

Basamento: esclusivi basamenti in metallo pressofuso, disponibili nella finitura Petrol o Bronzo.

Structure: in metal and plywood. Equipped with a rail system for fixing backrests.

Preparation of the base frame: In high resilience variable-density polyurethane foam. Upper layer with special breathable polyurethane foam MEMOSOFF and "Hi-tex": a last generation microfiber certificated OEKO-TEX STANDARD 100, fire resistant, 100% recyclable. Out covering with heat-bonded polyester fiber laminated to technical fiber.

Backrests: metal frame with high natural rubber content elastic strap webbing. Preparation of the frame in high resilience variable-density polyurethane foam. Out covering with heat-bonded polyester fiber laminated to cotton. The backrests are equipped with a flexible coupling system to the base structure.

Back cushion: channeled "Hi-tex", a last generation microfiber certificated OEKO-TEX STANDARD 100, fire resistant, 100% recyclable. Backrest cushion with headrest has ergonomic insert in polyurethane foam shaped under numerical control.

Covers: are completely removable in fabric and leather version.

Base: special design die-cast metal feet, painted Pewter or Bronze.

COSY

Dimensioni e altezze di seduta
Sitting depth and sofa back height

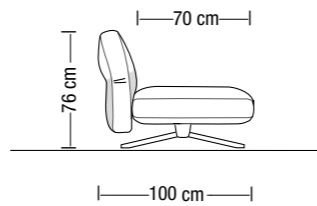
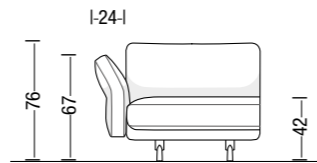

Dimensioni e altezze di seduta con cuscini
Sitting depth and sofa height with cushions

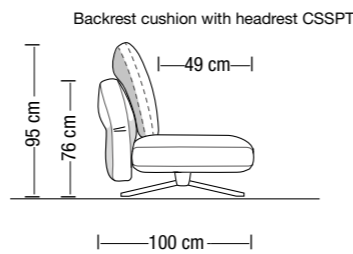
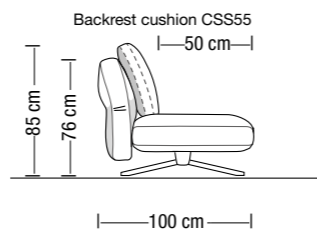

**Poltrona
Armchair**
CS139

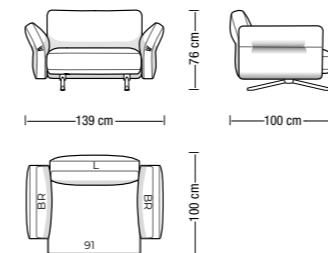

**Divani
Sofas**
CS200

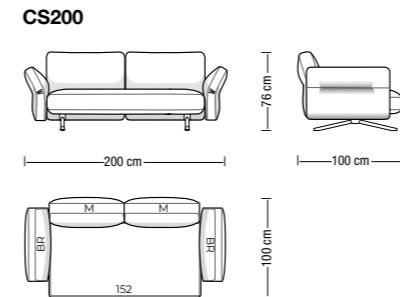

CS230

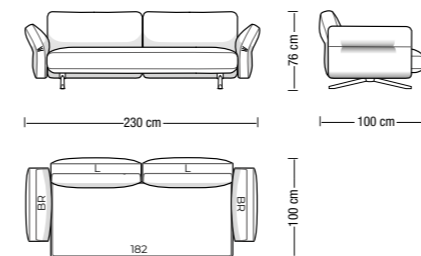

CS276

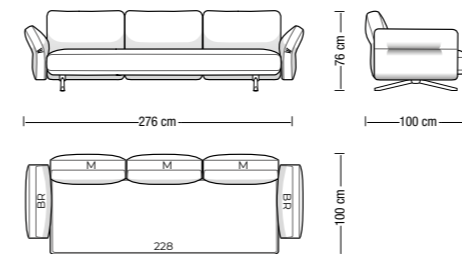

**Divani con penisola
Open-end sofas**

CS176SLB

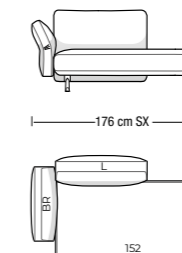

CS176DLB

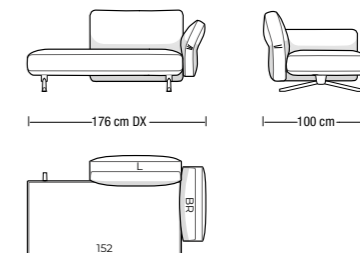

CS206S2MB

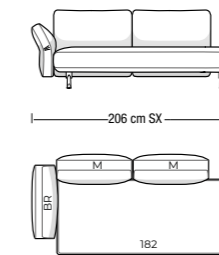

CS206D2MB

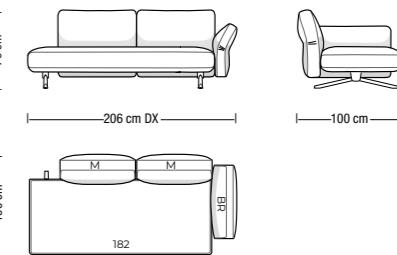

CS252S2LB

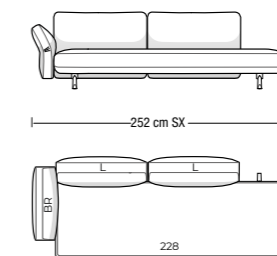

CS252D2LB

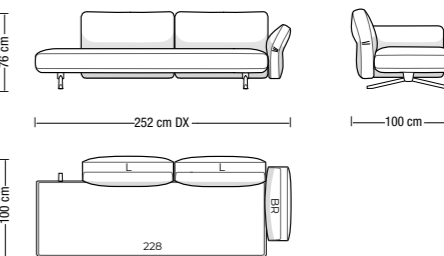

**Finiture basamento
Metal base finish**



Petro
Pewter



Bronzo
Bronze



Divani 1 bracciolo
Elements with 1 armrest

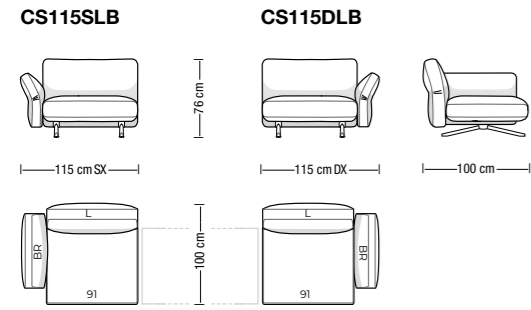

Terminali con penisola
Open-end terminal elements

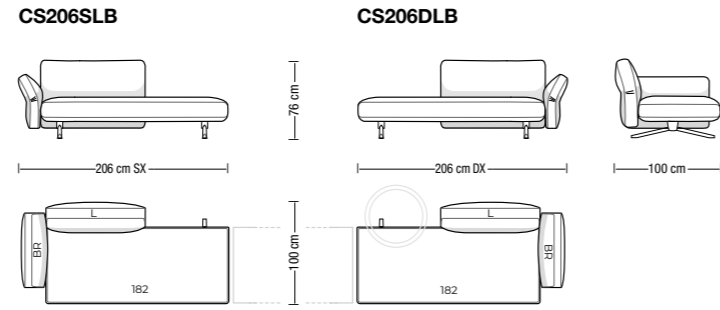

Terminali angolari con bracciolo
Corner elements with armrest

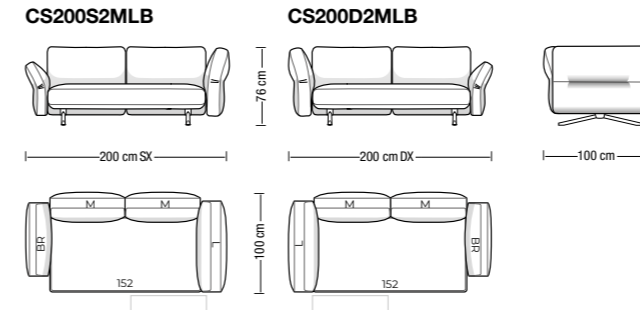

Terminali penisola
Open-end terminal elements

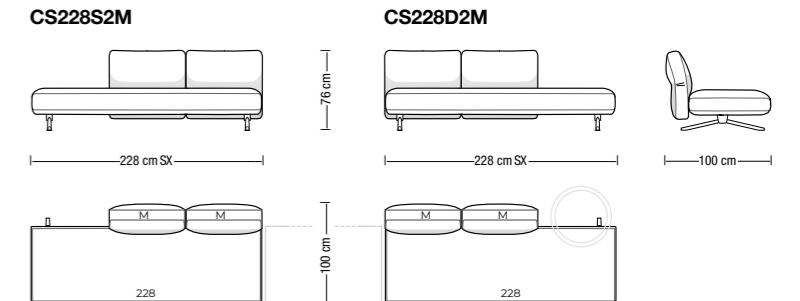
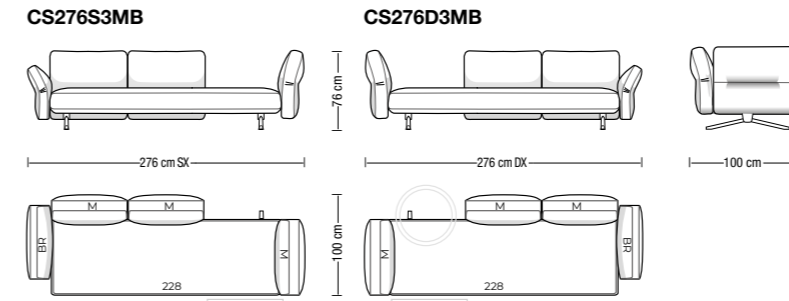
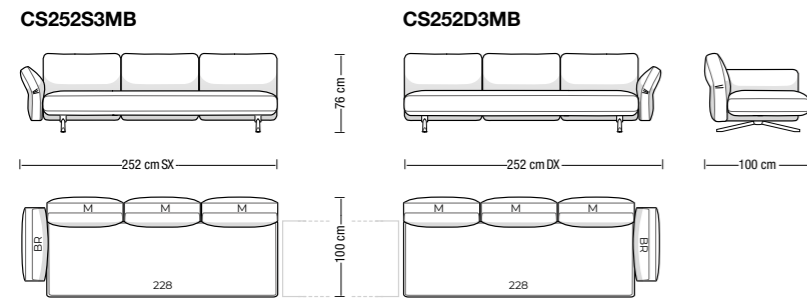
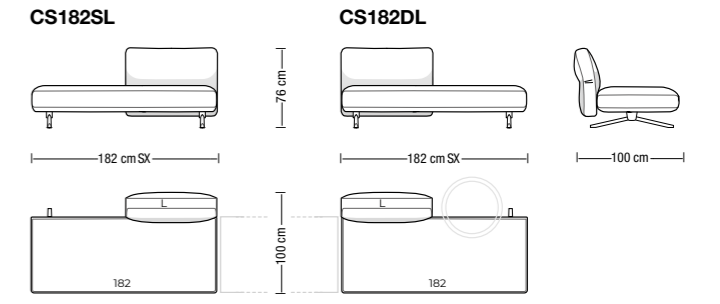
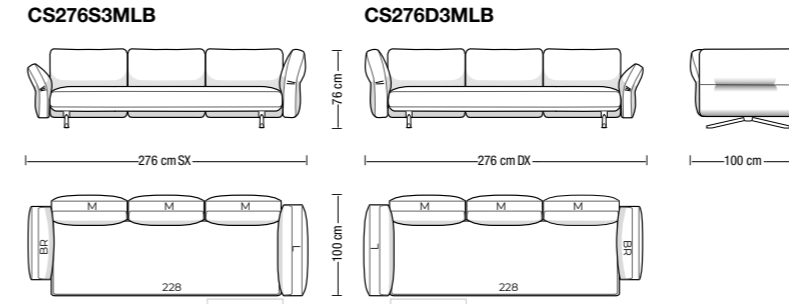
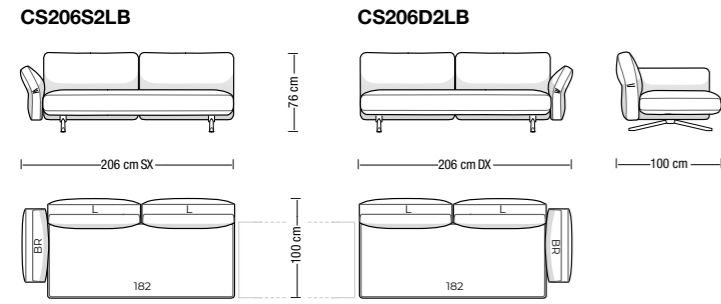
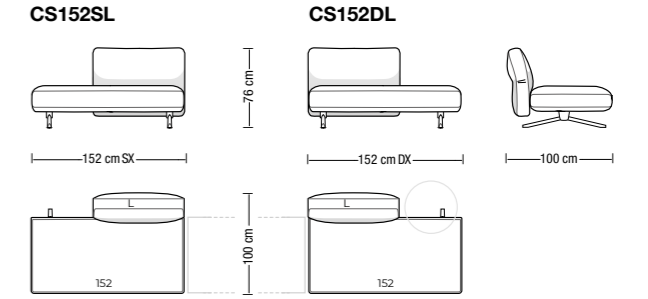
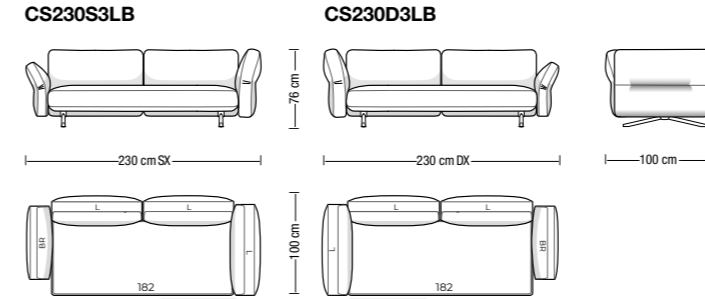
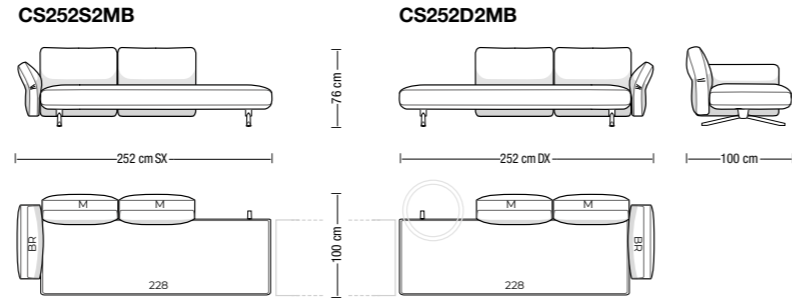
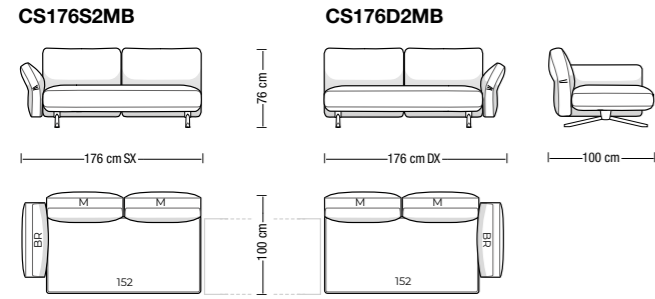
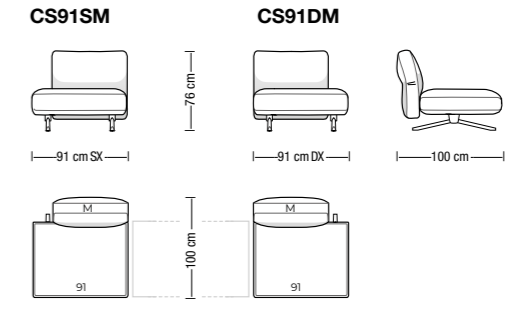

Angolari e terminali penisola da 176 cm
Corner and terminal elements 176 cm

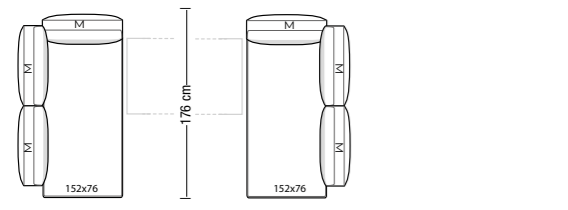
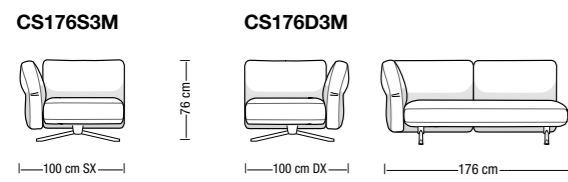
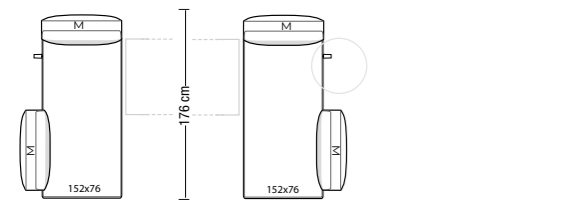
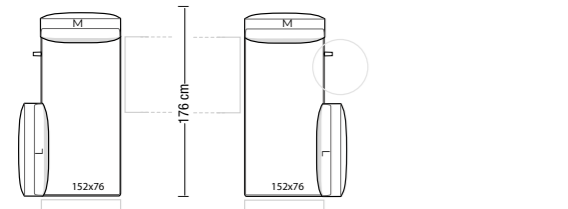
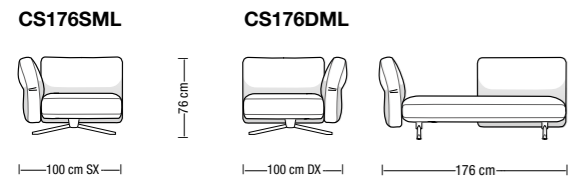
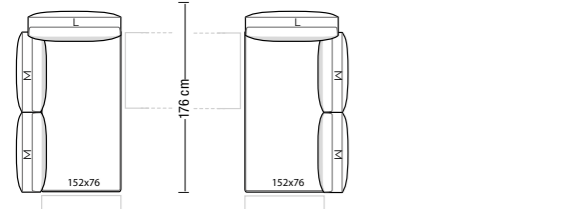

Terminali angolari e penisole da 206 cm
Corner and terminal elements 206 cm

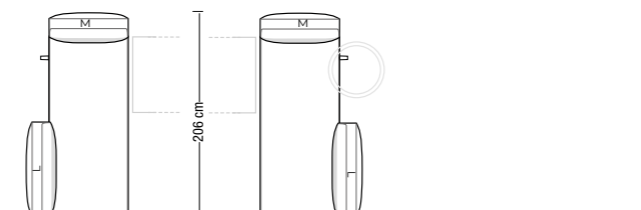
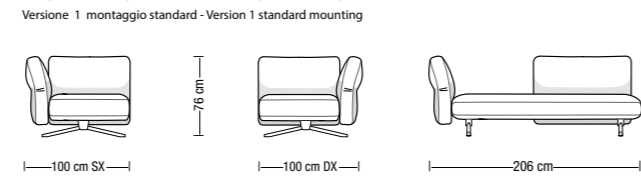
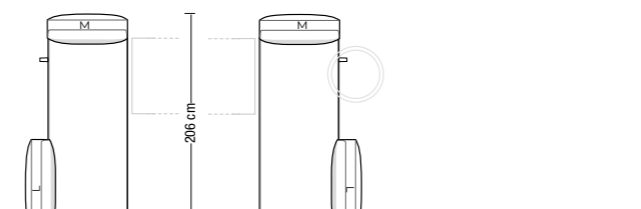
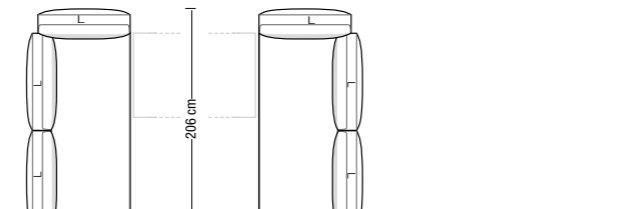

Versione - Version 2

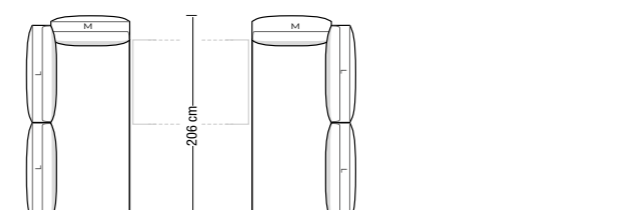

Terminali angolari e penisole da 252 cm
Corner and terminal elements 252 cm

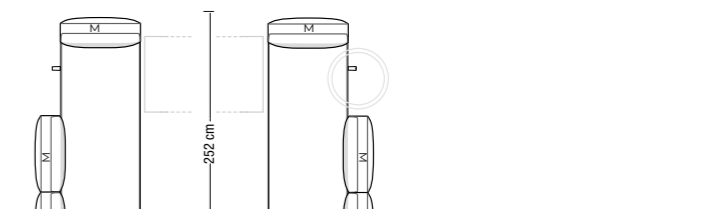
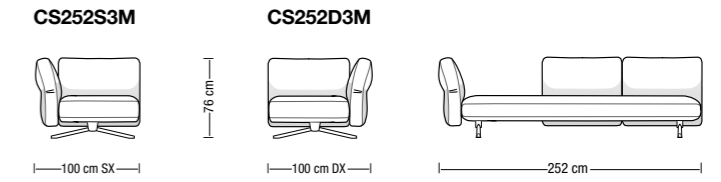
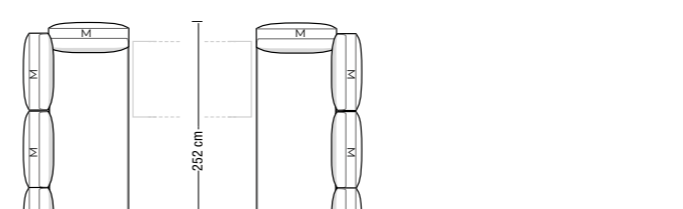
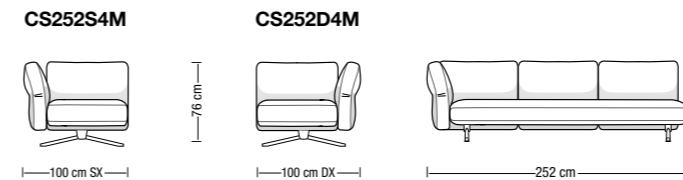
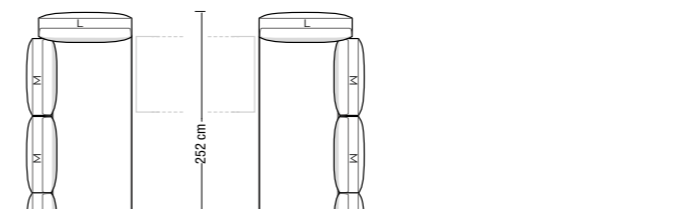
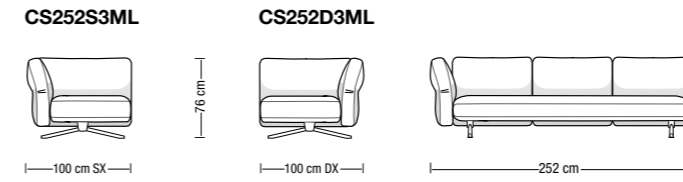

Versione 1 montaggio standard - Version 1 standard mounting

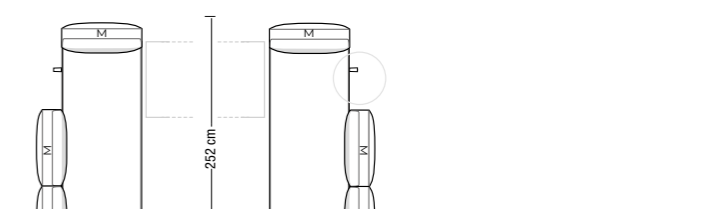
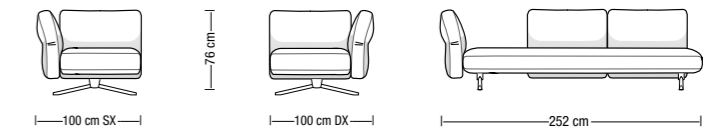

Versione - Version 2

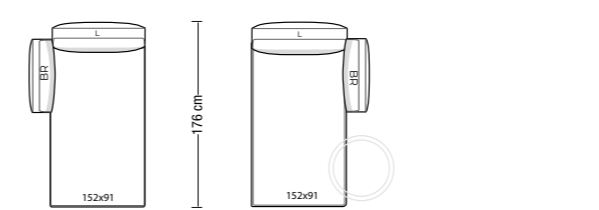
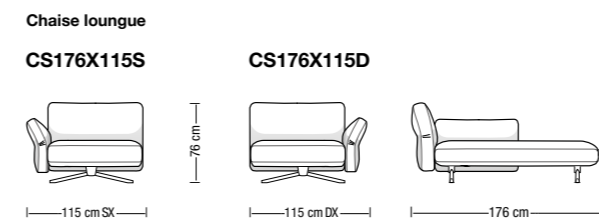

Divani senza braccioli ed elementi centrali
Central elements

CS91L

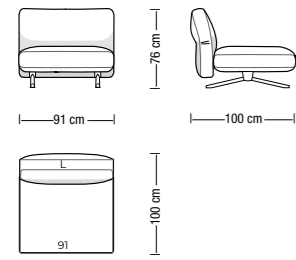

CS1822L

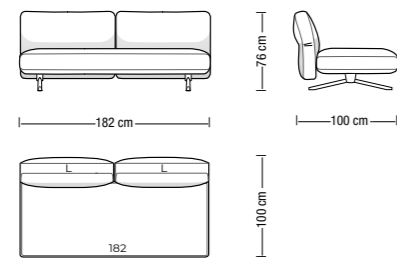

CS1522M

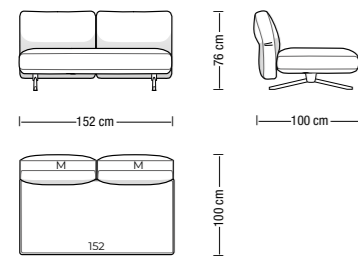

CS1822M

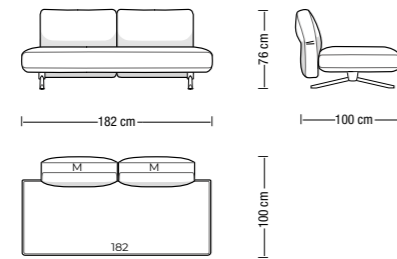

CS2283M

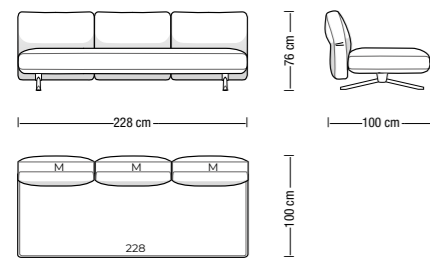

CS2282M

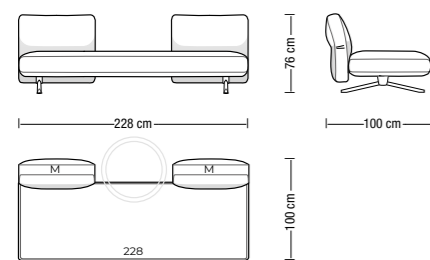

Versione 1 montaggio standard - Version 1 standard mounting

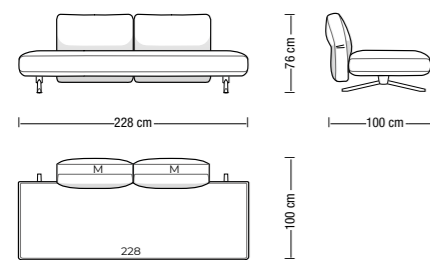

Versione - Version 2

Moduli pentagonali
Pentagonal elements

CS5S3M

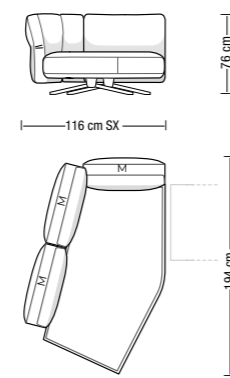

CS5D3M

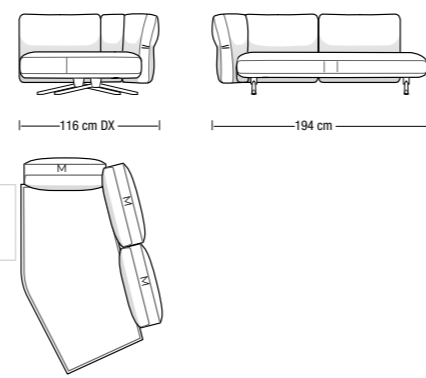

CS5S2M

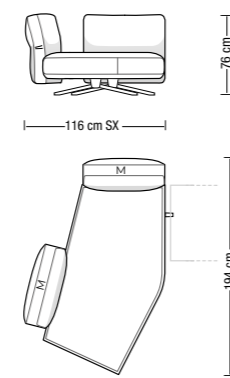

CS5D2M

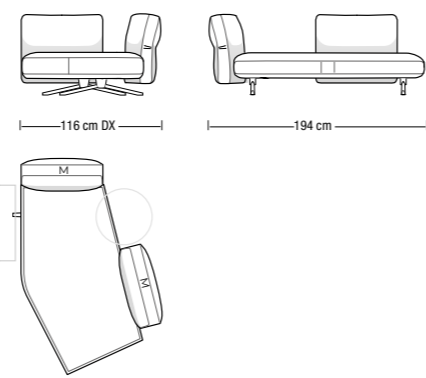

CS5S2L

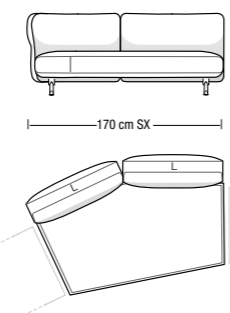

CS5D2L

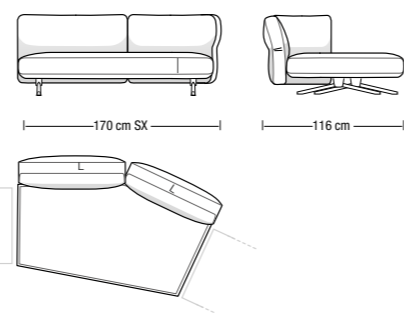

CS5SML

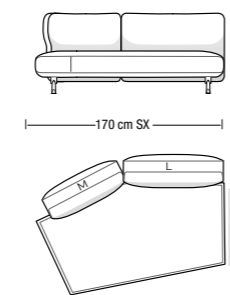

CS5DML

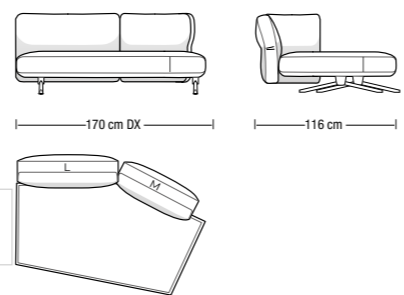

Composizioni suggerite
Suggested Compositions

CS1

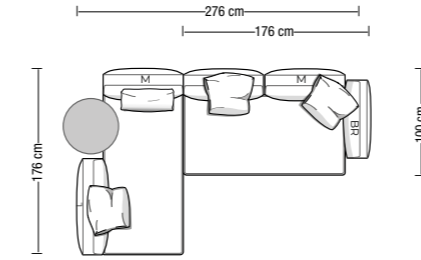

CS2

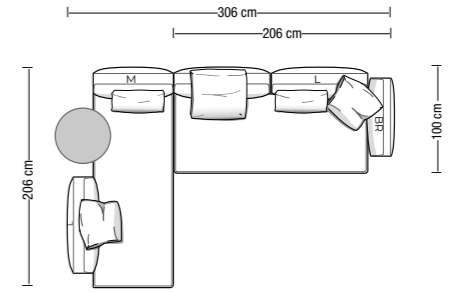

CS3

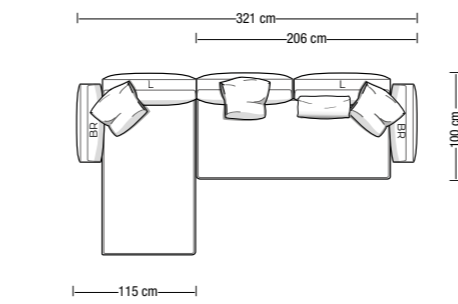

CS4

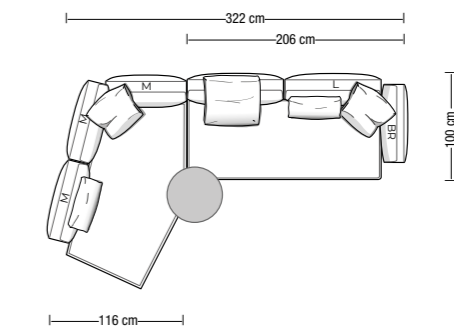

CS5

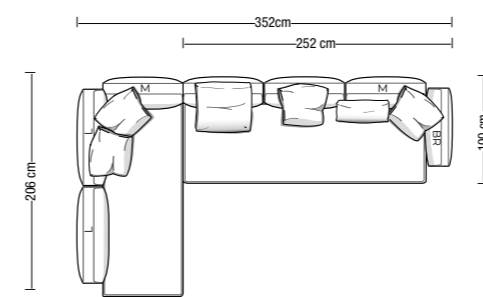

CS6

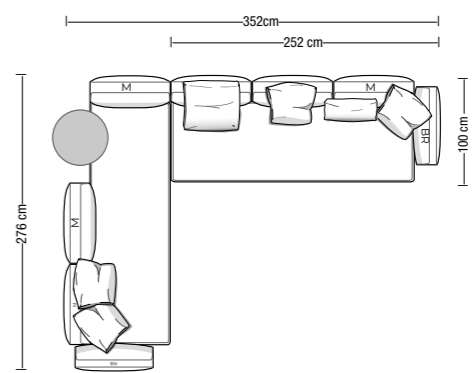

Struttura portante: in legno massello e multistrato monoscocca con molleggio garantito da cinghie elastiche ad alta componente di caucciù.

Preparazione della struttura: in poliuretano espanso a quote differenziate ad alta densità e resilienza. Ulteriore rivestimento della struttura con fibra di poliestere termolegata di forte spessore, accoppiata con vellutino.

Preparazione della struttura di seduta: in poliuretano espanso a quote differenziate ad alta densità e resilienza.

Layer superiore di seduta in poliuretano espanso speciale ad alta traspirabilità MEMOSOFF e microfibra "Hi-tex": imbottitura di ultima generazione ad alto fattore di comfort, certificata OEKO-TEX STANDARD 100, ignifuga, ecocompatibile, 100% riciclabile.

Ulteriore rivestimento della struttura con fibra di poliestere termolegata di forte spessore, accoppiata con vellutino.

Cuscineria di seduta: imbottitura cuscino di seduta in poliuretano espanso a densità differenziate. Layer superiore di seduta in poliuretano espanso speciale ad alta traspirabilità MEMOSOFF. Rivestimento in ovatta di poliestere siliconata ad alto spessore, accoppiata con tela di cotone bianca.

Cuscini schienale: totalmente imbottiti in microfibra "Hi-tex" canalizzata, di ultima generazione. Cuscini schienali poggiatesta con inserto ergonomico in poliuretano espanso sagomato a controllo numerico.

Cuscini ornamentali: in piuma d'oca canalizzata certificata "Assopiuma".

Sfoderabilità: rivestimento sfoderabile nella versione in tessuto, fisso nella versione in pelle. Cuscini seduta e schienale sempre sfoderabili.

Basamento: speciali piedi arretrati in ABS con gomma antiscivolo che permettono il posizionamento delle composizioni divani senza ganci o connessioni fra gli elementi.

Structure: in solid wood and plywood, monocoque, with high natural rubber content elastic strap webbing.

Preparation of the frame: in high resilience variable-density polyurethane foam. Out covering with heat-bonded polyester fiber laminated to technical fiber.

Preparation of the seat: in high resilience variable-density polyurethane foam. Upper layer with special breathable polyurethane foam MEMOSOFF and "Hi-tex": a last generation microfiber certificated OEKO-TEX STANDARD 100, fire resistant, 100% recyclable. Out covering with heat-bonded polyester fiber laminated to technical fiber.

Seat cushion: in high resilience variable-density polyurethane foam with MEMOSOFF (breathable polyurethane foam), covered with a high depth polyester silicon fiber heat-bonded to white cotton canvas.

Back cushion: channeled "Hi-tex", a last generation microfiber certificated OEKO-TEX STANDARD 100, fire resistant, 100% recyclable. Backrest cushion with headrest has ergonomic insert in polyurethane foam shaped under numerical control.

Ornamental cushion: channeled goose down, certified "Assopiuma".

Covers: are completely removable in fabric version and fixed in leather version. Seat cushion and backrest cushion covers are completely removable.

Base: specials half-hidden ABS feet, non-slip rubber allows to join sofa without junction hook.

GLAM

Dimensioni e altezze di seduta
Sitting depth and sofa height

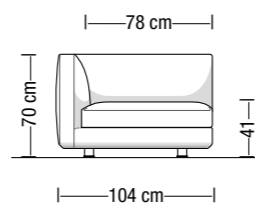

Dimensioni e altezze di seduta con cuscini
Sitting depth and sofa height with cushions

Backrest cushion with headrest GLS60PT

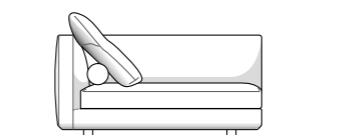
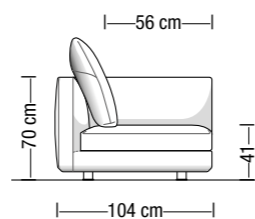

Backrest cushion GLS65 e GLS80

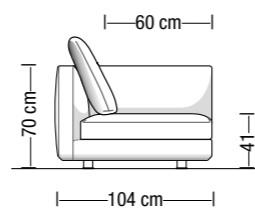

Sono disponibili misure speciali su richiesta. I disegni a catalogo sono da considerarsi suggerimenti di configurazione: schienali e cuscini sono elementi liberamente abbinabili.

Custom-made elements are available on request. Drawings are configuration suggestions: backrests and cushions are freely combinable elements.



Divano da 196 cm
Sofa 196 cm

GL196

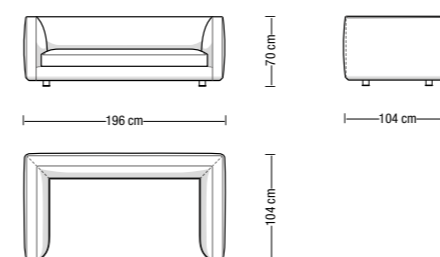

Divano da 226 cm
Sofa 226 cm

GL226

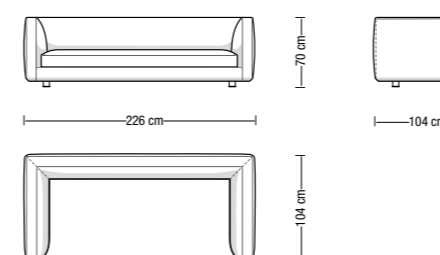

Divano da 262 cm
Sofa 262 cm

GL262

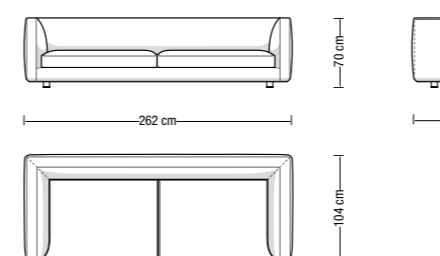

Divano da 344 cm (2 x 172 cm)
Sofa 344 cm (2 x 172 cm)

GL344

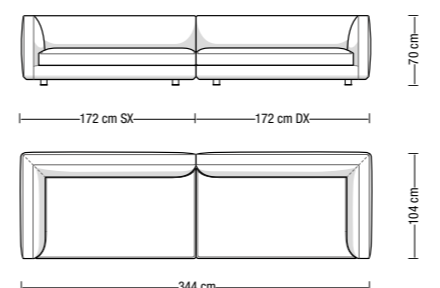

Divano a 1 bracciolo da 132 cm
Element with 1 armrest 132 cm

GL132S

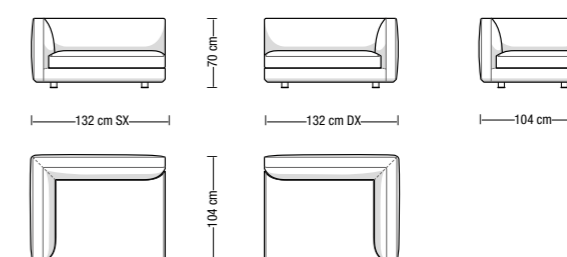

Divano a 1 bracciolo da 172 cm
Element with 1 armrest 172 cm

GL172S

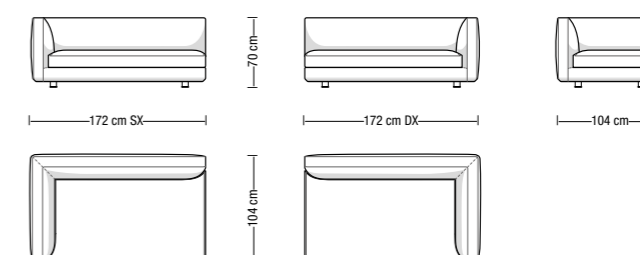

Divano a 1 bracciolo da 202 cm
Element with 1 armrest 202 cm

GL202S

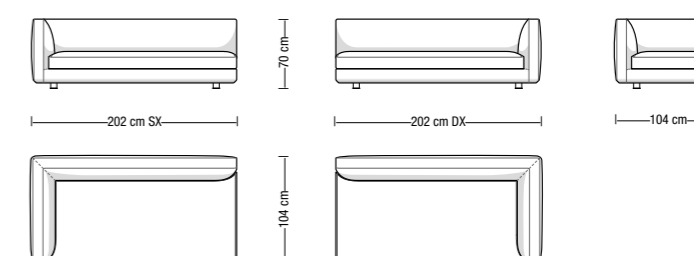

Divano a 1 bracciolo da 238 cm
Element with 1 armrest 238 cm

GL238S

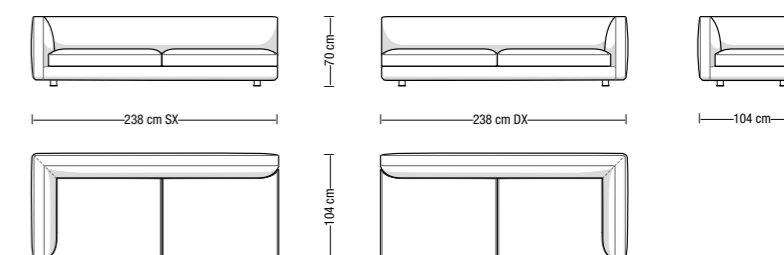

Angolare da 132 cm
Corner element 132 cm

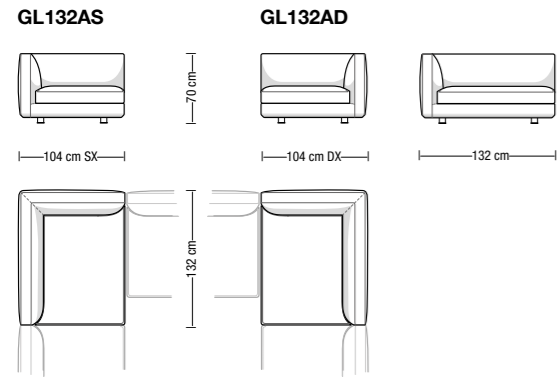

Terminale/Angolare da 172 cm
Terminal/Corner element 172 cm

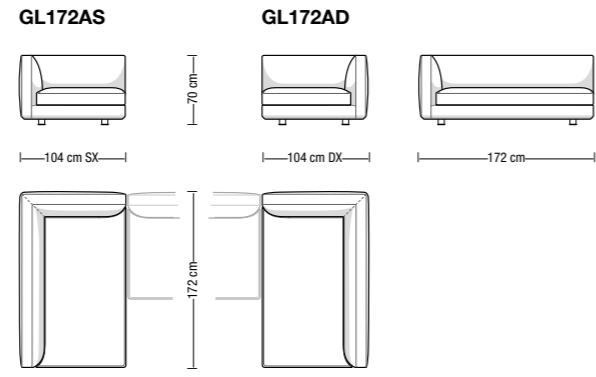

Terminale/Angolare da 202 cm
Terminal/Corner element 202 cm

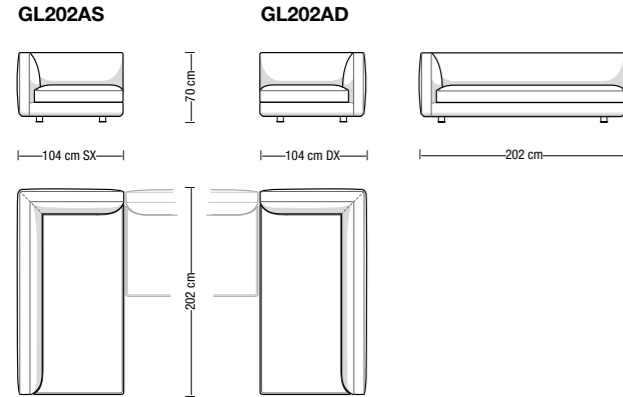

Terminale/Angolare da 238 cm
Terminal/Corner element 238 cm

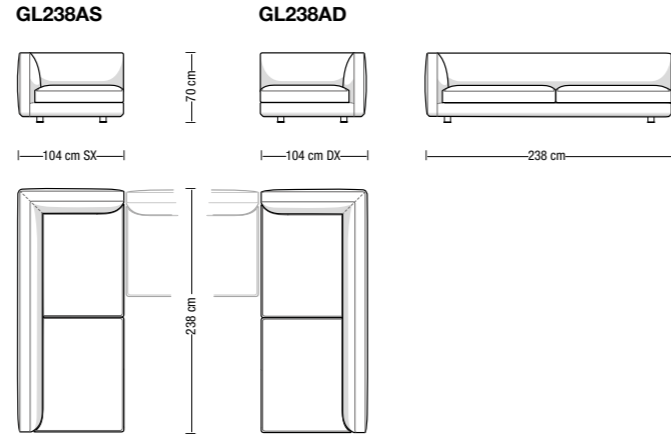

Elemento centrale da 104 cm
Central element 104 cm

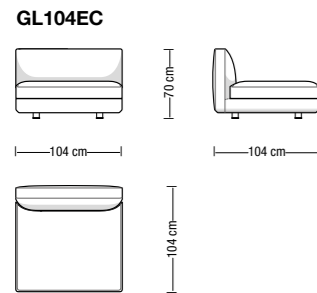

Elemento centrale da 146 cm
Central element 146 cm

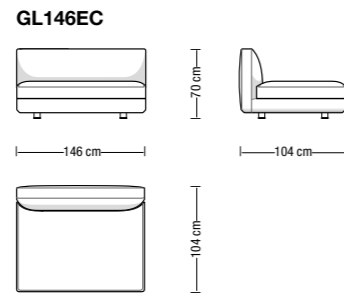

Elemento centrale da 176 cm
Central element 176 cm

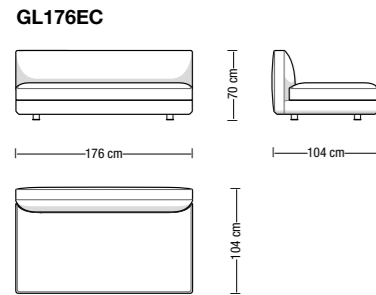

Elemento centrale da 212 cm
Central element 212 cm

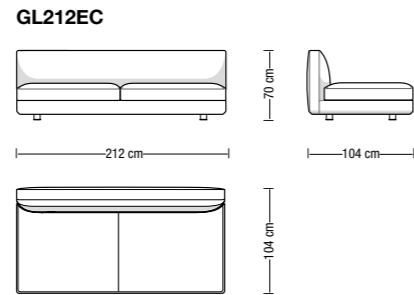

Terminale/Angolare aperto da 132 cm
Open terminal element 132 cm

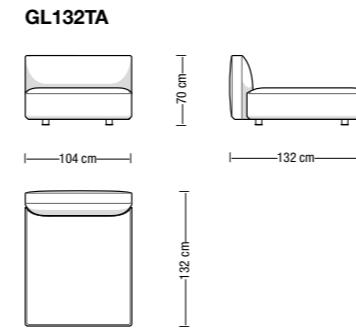

Elemento aperto da 104x104 cm
Open element 104x104 cm

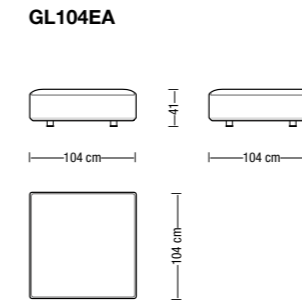

Elemento aperto da 132 cm
Open element 132 cm

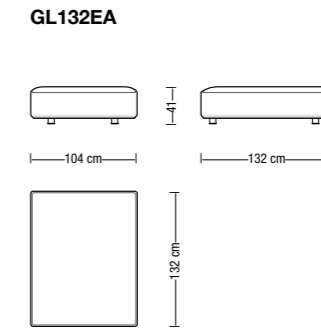

Pouff da 104x53 cm
Ottoman 104x53 cm

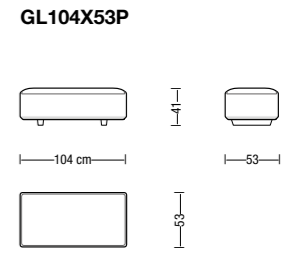

Chaise longue/Terminale aperto da 172 cm
Chaise longue/Open terminal element 172 cm

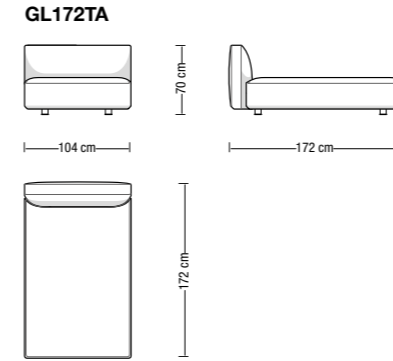

Elemento aperto da 172 cm
Open element 172 cm

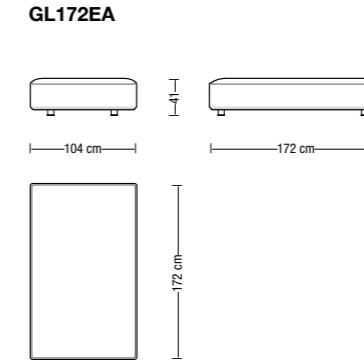

Elemento aperto da 202 cm
Open element 202 cm

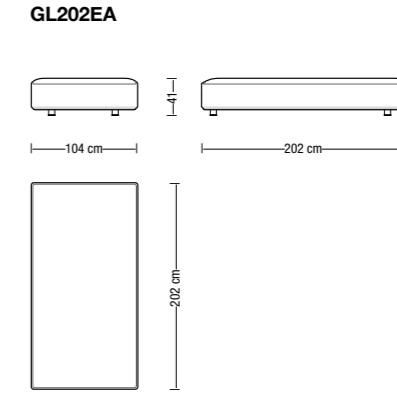

Chaise longue/Terminale aperto da 202 cm
Chaise longue/Open terminal element 202 cm

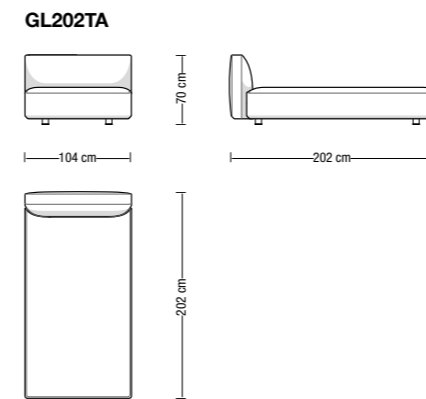

Cuscino schienale poggiatesta
Backrest cushion headrest

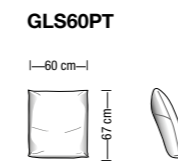

Cuscino 45x45 piuma
Cushion 45x45 feather

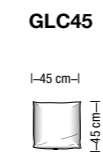

Schienale mobile
Movable backrest

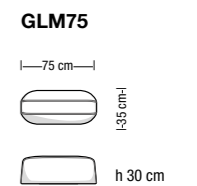

Cuscino schienale da 65 cm
Backrest cushion 65 cm



Cuscino 58x58 piuma
Cushion 58x58 feather

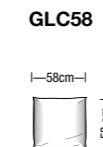

Cuscino schienale da 80 cm
Backrest cushion 80 cm

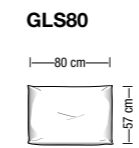

Poggiareni
Lumbar rest

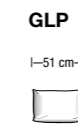

Rullo
Bolster



Composizioni suggerite
Compositions suggested

CG1 304x104 cm + bench

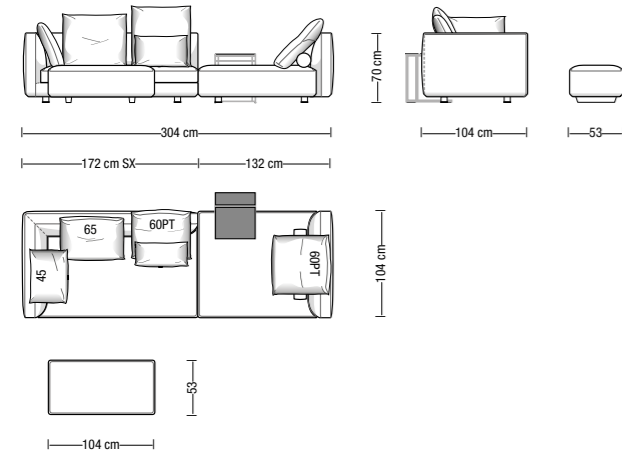

CG5 374x321 cm

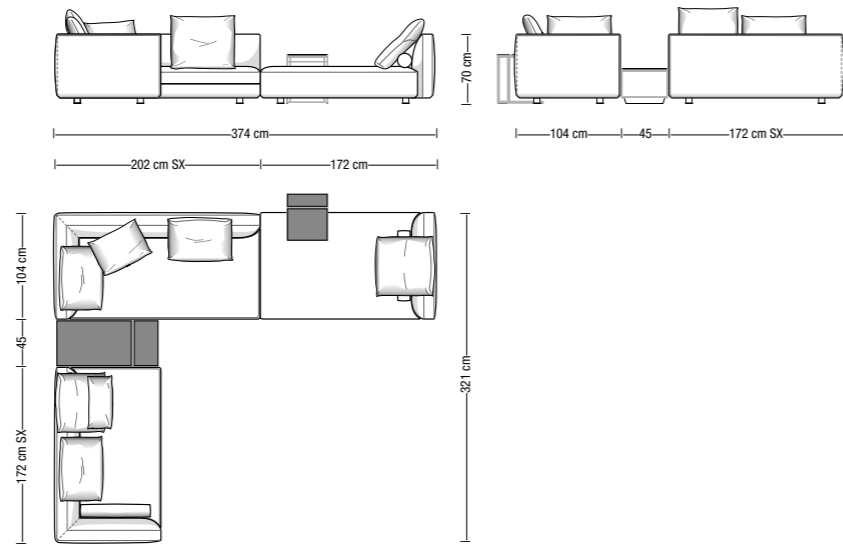

Composizioni suggerite
Compositions suggested

CG3 351x202 cm + bench

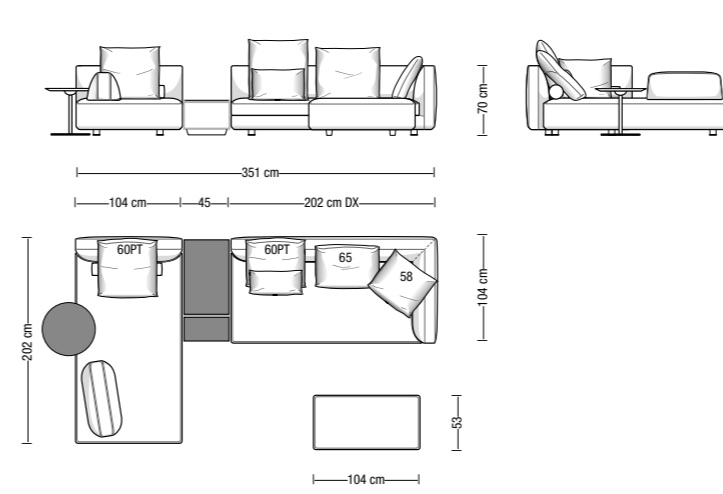

CG7 389x104 cm + bench

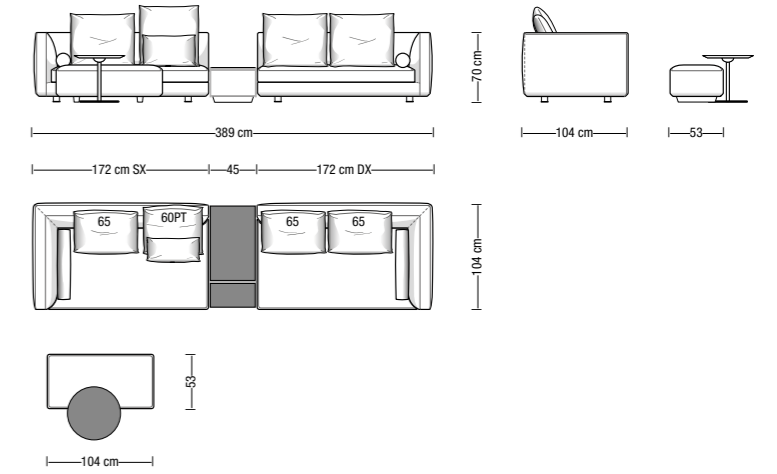

CG2 276x172 cm

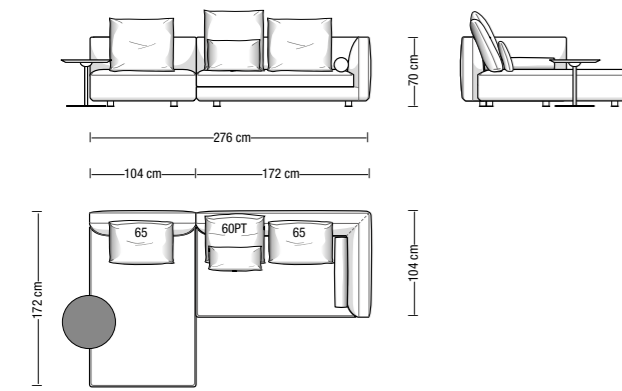

CG6 306x264 cm

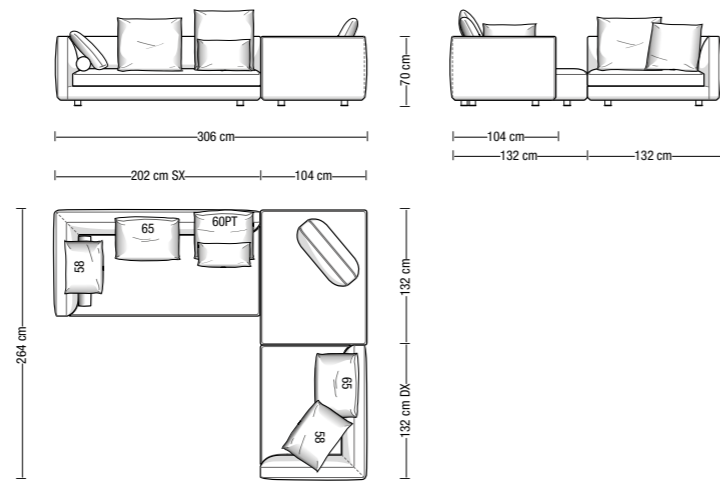

CG4 344x261 cm

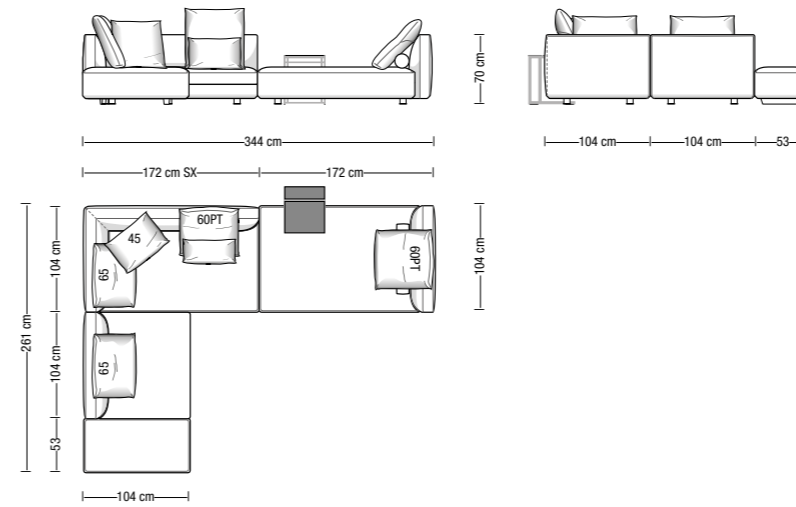

CG8 334x306 cm

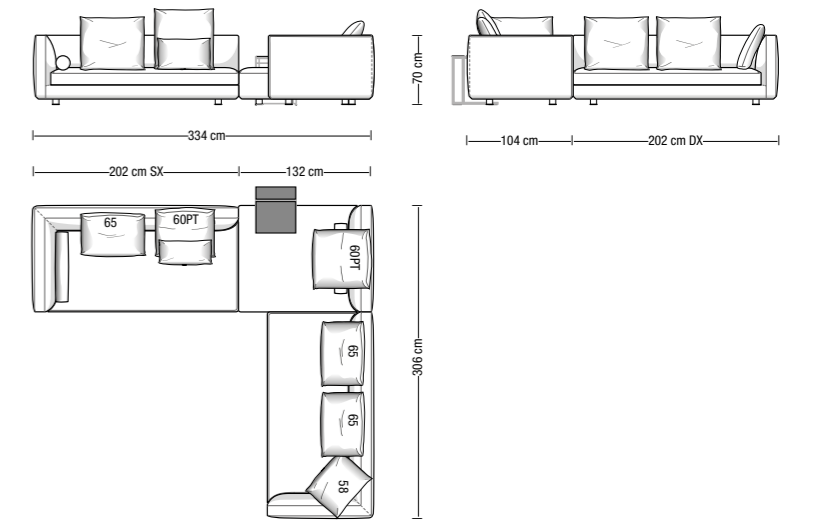

Struttura portante: in legno massello e multistrato monoscocca con molleggio garantito da cinghie elastiche ad alta componente di caucciù.

Preparazione della struttura: in poliuretano espanso a quote differenziate ad alta densità e resilienza. Layer superiore di seduta in poliuretano espanso speciale MEMOSOFF. Ulteriore rivestimento della struttura in microfibra "Hi-tex", accoppiata con vellutino.

Schienali mobili: realizzati con 3 differenti parti in poliuretano sagomate a controllo numerico, a densità differenziata, ad alta resilienza. All'interno dell'assemblaggio delle imbottiture è predisposta una lastra d'acciaio che equilibra il manufatto. Ulteriore rivestimento dello schienale con fibra di poliestere termolegata, accoppiata con vellutino. Alla base dello schienale è predisposto, unito al rivestimento, uno speciale elastomero di derivazione nautica che permette l'ancoraggio per attrito.

Braccioli mobili: realizzati in poliuretano a densità differenziata. All'interno dell'assemblaggio delle imbottiture è predisposta una lastra d'acciaio che equilibra il manufatto. Ulteriore rivestimento del bracciolo con fibra di poliestere termolegata accoppiata con vellutino. Alla base del bracciolo è predisposto, unito al rivestimento, uno speciale elastomero di derivazione nautica che permette l'ancoraggio per attrito.

Cuscini schienale: totalmente imbottiti in microfibra "Hi-tex" canalizzata, di ultima generazione. Cuscini schienali poggiatesta con inserto ergonomico in poliuretano espanso sagomato a controllo numerico.

Sfoderabilità: rivestimento sfoderabile in tutte le versioni (tessuto e pelli soft touch).

Basamento: esclusivi basamenti in alluminio e acciaio. Il piede in estruso d'alluminio dona leggerezza mentre la slitta a terra in acciaio speciale ad alta componente di carbonio garantisce resistenza, stabilità ed elasticità. Disponibile nella finitura Peltro.

Structure: in solid wood and plywood, monocoque with high natural rubber content elastic strap webbing.

Preparation of the seat: in high resilience variable-density polyurethane foam. Upper layer with special polyurethane foam MEMOSOFF. Outer covering with "Hi-tex" microfiber laminated to technical fiber.

Movable backrest: made with 3 different high resilience polyurethane parts shaped under numerical control. Backrest construction has inside a metal plate. Additional cover in heat-bonded polyester fiber laminated to technical fiber. Thanks to a special nautical elastomer fixed with the cover, backrest attach on the base.

Movable armrest: in variable-density polyurethane foam. Armrest construction has inside a metal plate. An additional cover in heat-bonded polyester fiber laminated to technical fiber. Thanks to a special nautical elastomer fixed with the cover, armrest attach on the base.

Back cushion: channeled "Hi-tex", a last generation microfiber certificated OEKO-TEX STANDARD 100, fire resistant, 100% recyclable. Backrest cushion with headrest has ergonomic insert in polyurethane foam shaped under numerical control.

Covers: completely removable in all version (fabric and leather soft touch).

Base: exclusive extruded aluminum and carbon steel bases. Available painted Pewter.

FILIPH AIR

Dimensioni e altezze di seduta
Sitting depth and sofa height

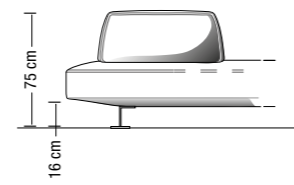

Altezza cuscino orizzontale
Horizontal backrest cushion

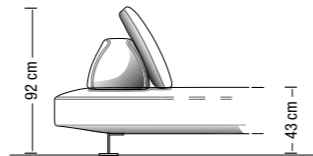

Altezza cuscino poggiatesta
Backrest cushion with headrest

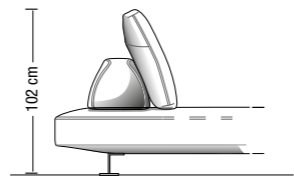

reddot design award
winner 2018

Sono disponibili misure speciali su richiesta.
I disegni a catalogo sono da considerarsi suggerimenti di configurazione:
schienali e cuscini sono elementi liberamente abbinabili.

Custom-made elements are available on request.
Drawings are configuration suggestions:
backrests and cushions are freely combinable elements.

Divano da 125 cm
Sofa 125 cm

FA125

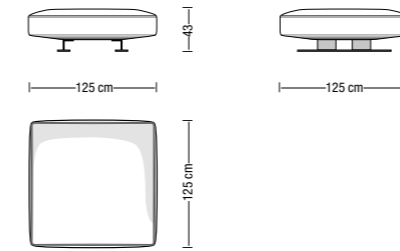

Esempio di disposizione di schienale mobile
Movable backrest placement example

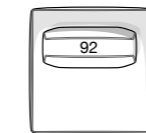

Divano da 175 cm
Sofa 175 cm

FA175

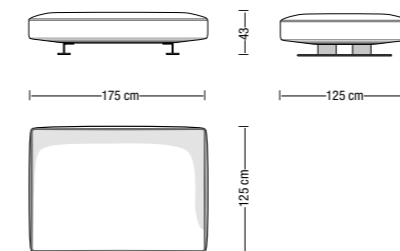

Esempi di disposizione di schienali mobili
Movable backrests placement examples

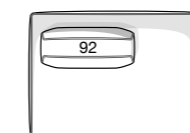
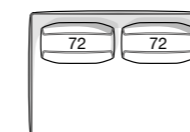

Divano da 195 cm
Sofa 195 cm

FA195

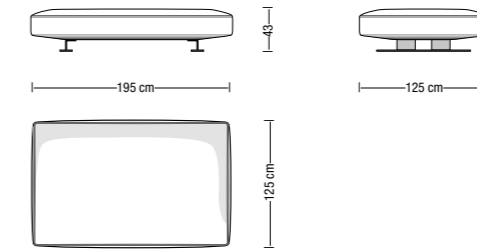

Esempi di disposizione di schienali mobili
Movable backrests placement examples

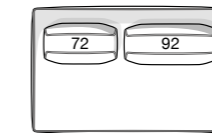

Divano da 225 cm
Sofa 225 cm

FA225

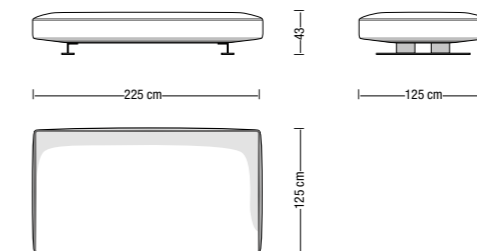

Esempio di disposizione di schienali mobili
Movable backrests placement example

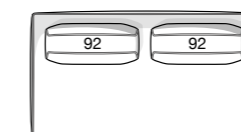

Divano da 255 cm
Sofa 255 cm

FA255

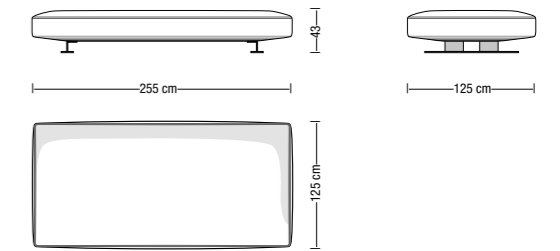

Esempi di disposizione di schienali mobili
Movable backrests placement examples



Divano da 285 cm
Sofa 285 cm

FA285

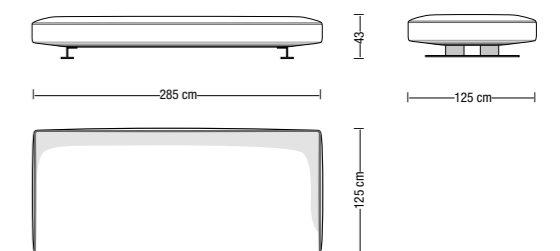

Esempi di disposizione di schienali mobili
Movable backrests placement examples



Divano da 110x110 cm
Sofa 110x110 cm

FA110X

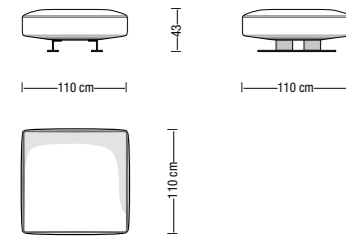

Esempio di disposizione di schienale mobile
Movable backrest placement example

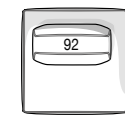

Divano da 175x110 cm
Sofa 175x110 cm

FA175X

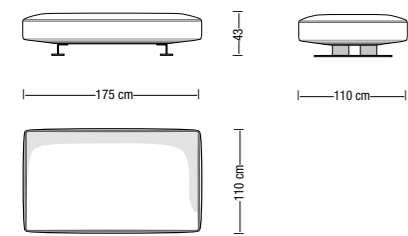

Esempi di disposizione di schienali mobili
Movable backrests placement examples

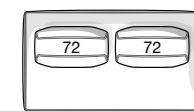

Divano da 195x110 cm
Sofa 195x110 cm

FA195X

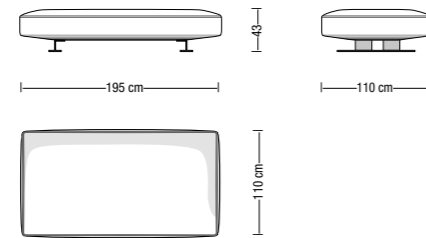

Esempi di disposizione di schienali mobili
Movable backrests placement examples

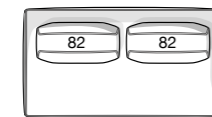
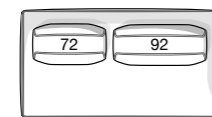

Divano da 225x110 cm
Sofa 225x110 cm

FA225X

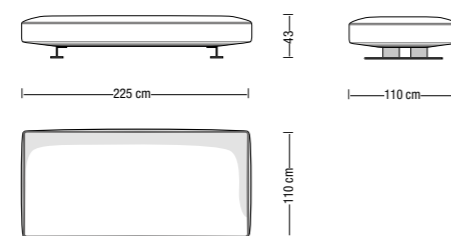

Esempio di disposizione di schienali mobili
Movable backrests placement example

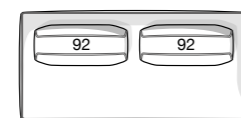

Divano da 255x110 cm
Sofa 255x110 cm

FA255X

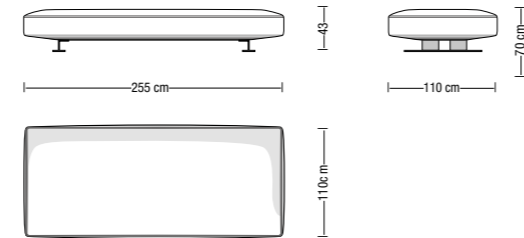

Esempi di disposizione di schienali mobili
Movable backrests placement examples

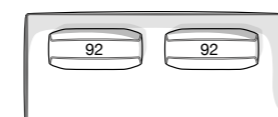
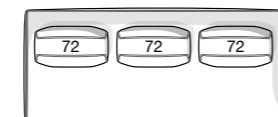

Divano trapezoidale da 210x122 cm
Trapezoidal sofa 210x122 cm

FA210W

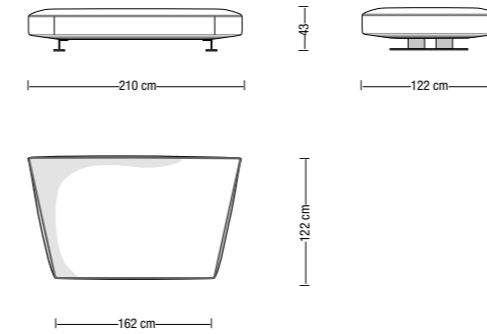

Chaise-longue trapezoidale da 138x175 cm
Trapezoidal chaise-longue 138x175 cm

FA138CLW

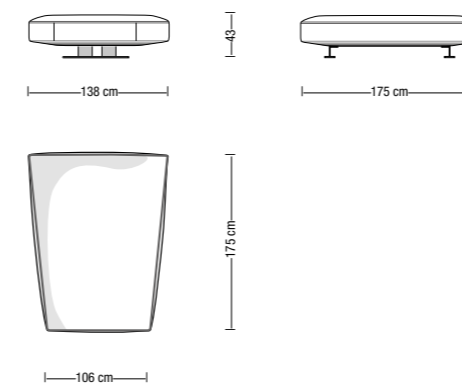

Esempio di disposizioni schienale mobile
movable backrest placement example

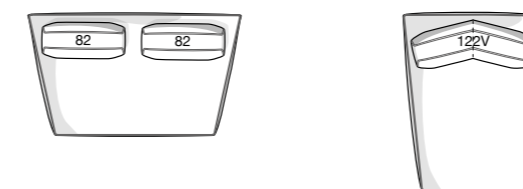

Divano Pentagonale
Pentagonal Sofa

FA5

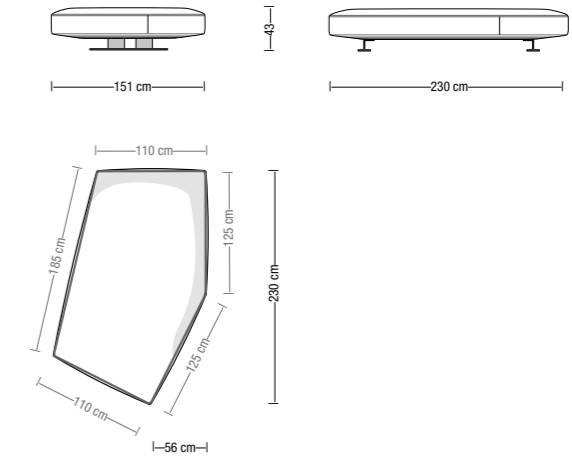

Configurazioni divano pentagonale ed esempi di disposizioni schienale mobile
Pentagonal sofa layouts and movable backrest placement example

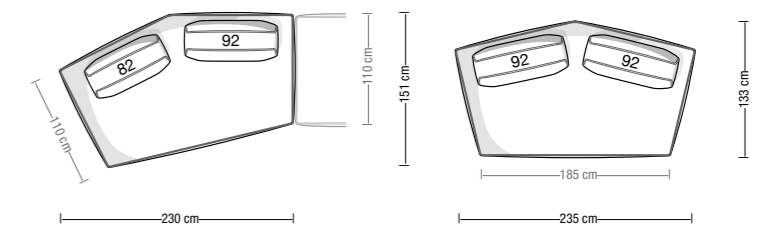
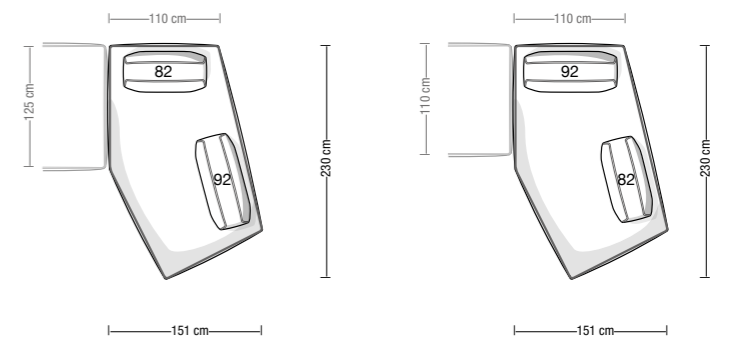

Schienali mobili
Movable backrests

Schienale mobile 72
Movable backrest 72

FLM72

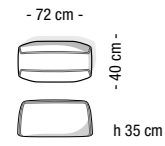

Schienale mobile 82
Movable backrest 82

FLM82

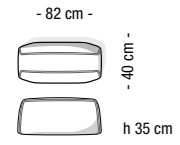

Schienale mobile 92
Movable backrest 92

FLM92

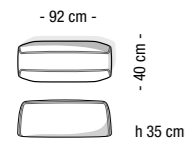

Schienale mobile 122V
Movable backrest 122V

FLM122V

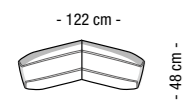

Cuscini - Schienali
Backrests

Cuscino schienale poggiatesta
Backrest cushion headrest

FLSPT

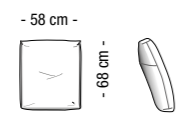

Bracciolo mobile
Movable armrest

FLB

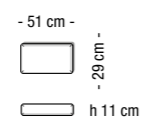

Cuscino schienale orizzontale
Horizontal backrest

FLSO

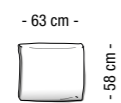

Cuscino schienale verticale
Vertical backrest

FLSV

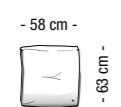

Poggiareni
Lumbar rest

FLP

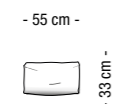

Pouf Filiph Air
Filiph Air ottomans

Pouf da 63x53 cm
Ottoman 63x53 cm

FA63X53

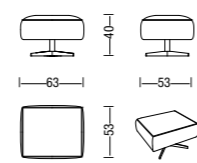

Pouf abbinabili a Filiph Air
Ottomans matchable with Filiph Air

Pouf Love 63 cm
Ottoman Love 63 cm

LV63P

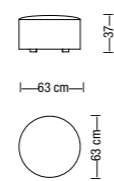

Pouf Love 83 cm
Ottoman Love 83 cm

LV83P

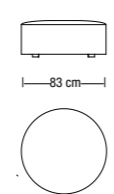

Composizioni suggerite
Compositions suggested

FA1 255 x 125 cm

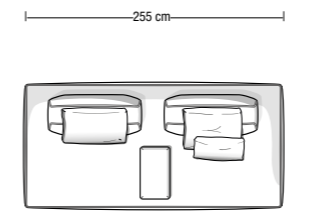

FA2 320 x 195 cm

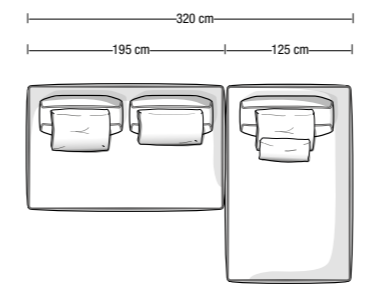

FA3 350 x 225 cm

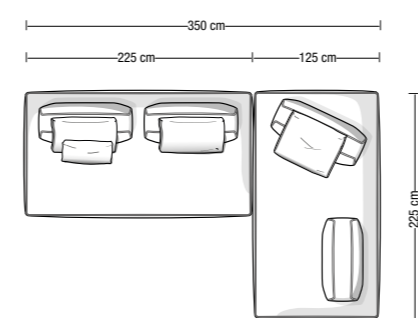

FA4 350 x 350 cm

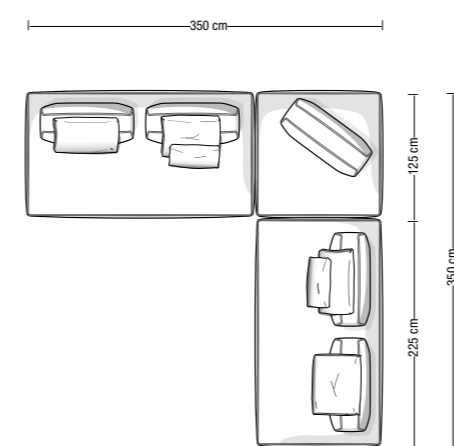

FA5 256-346 x 175-204 cm

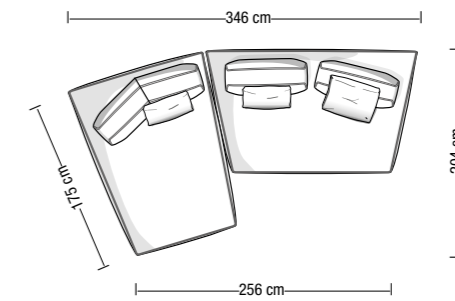

FA6 335-376 x 230 cm

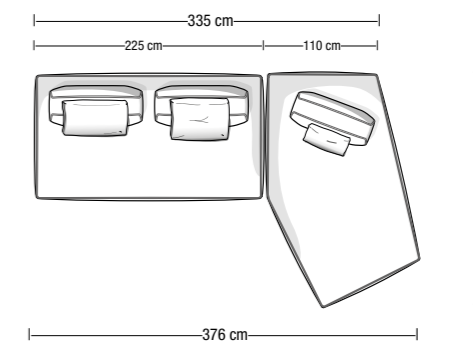

FA7 359 x 230 cm

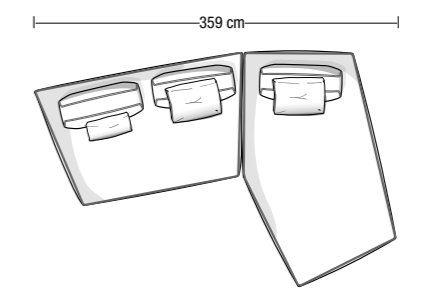

FAB 414 x 156 cm

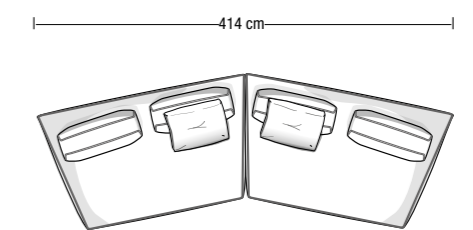

Struttura portante: in legno massello e multistrato monoscocca con molleggio garantito da cinghie elastiche ad alta componente di caucciù.

Preparazione della struttura: seduta in poliuretano espanso a quote differenziate ad alta densità e resilienza. Layer superiore di seduta in poliuretano espanso speciale MEMOSOFF. Ulteriore rivestimento della struttura in microfibra "Hi-tex", accoppiata con vellutino. Hi-tex è un imbottitura di ultima generazione ad alto fattore di comfort, certificata OEKO-TEX STANDARD 100, ignifuga, 100% riciclabile. Struttura schienale in poliuretano a quote differenziate ad alta densità e resilienza e poliuretano speciale ad alta traspirabilità "Polilatex Soft". Ulteriore rivestimento della struttura con fibra di poliestere accoppiata con vellutino.

Cuscini schienale: totalmente imbottiti in microfibra "Hi-tex" canalizzata, di ultima generazione. Cuscini schienali poggiatesta con inserto ergonomico in poliuretano espanso sagomato a controllo numerico.

Sfoderabilità: rivestimento sfoderabile nella versione in tessuto, previo smontaggio degli schienali. Fisso nella versione in pelle.

Basamento: esclusivi basamenti in estruso di alluminio lavorato a controllo numerico, con distanziali in MDF che integrano il sistema di unione degli elementi e degli schienali.

Structure: in solid wood and plywood with high natural rubber content elastic strap webbing.

Structure preparation: seat structure in high resilience variable-density polyurethane foam. Upper layer with special polyurethane foam MEMOSOFF. Outer covering with "Hi-tex" microfiber laminated to technical fiber. Hi-tex is an innovative padding, certificated OEKO-TEX STANDARD 100, fire resistant, 100% recyclable. Backrest structure in high resilience variable density polyurethane foam and "Polilatex soft" (special high breathable Polyurethane) covered with a high depth polyester fiber laminated to technical fiber.

Back cushion: channeled "Hi-tex", a last generation microfiber certificated OEKO-TEX STANDARD 100, fire resistant, 100% recyclable. Backrest cushion with headrest has ergonomic insert in polyurethane foam shaped under numerical control.

Covers: completely removable in fabric version, after disassembly of the backrest structure. Fixed in leather version.

Base: exclusives extruded aluminum bases, cutted under numerical control, with MDF spacers that integrate coupling system of elements and backrest structure.

CLOUD

Profondità e altezza di seduta con struttura schienale bassa
Sitting depth with low backrest

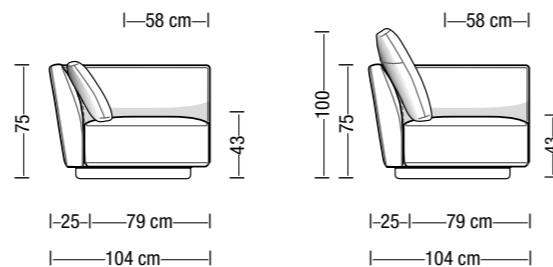

Profondità e altezza di seduta con struttura schienale alta
Sitting depth with hight backrest

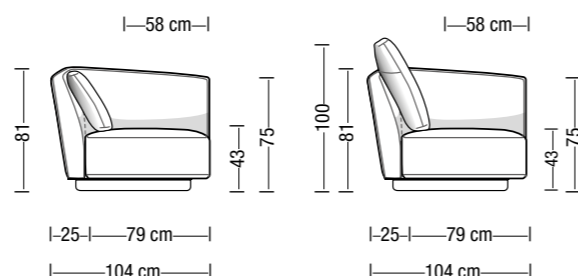

Sono disponibili misure speciali su richiesta. I disegni a catalogo sono da considerarsi suggerimenti di configurazione: schienali e cuscini sono elementi liberamente abbinabili.

Custom-made elements are available on request. Drawings are configuration suggestions: backrests and cushions are freely combinable elements.

CLOUD Limited Edition

La collezione CLOUD LE è caratterizzata dall'abbinamento, sulla medesima struttura, di 2 materiali di rivestimento diversi tra loro. L'interno dello schienale è realizzato con tessuto o pellame differente rispetto al resto del divano.

The CLOUD LE collection is characterised by the matching of two different cover materials on the same structure. The inner back features a fabric or leather which is different from the one used on the rest of the sofa.



Divano da 208 cm
Sofa 208 cm

CL208

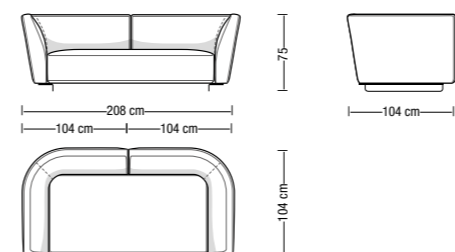

Divano da 253 cm Alto SX
Sofa 253 cm High left

CL253AS

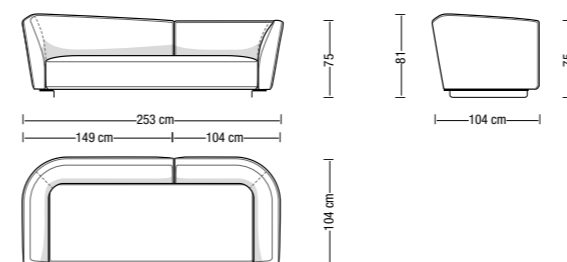

Divano da 253 cm Alto DX
Sofa 253 cm High right

CL253AD

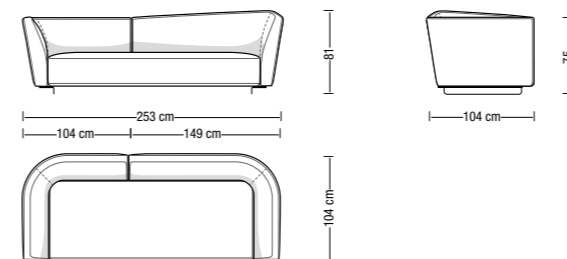

Divano da 298 cm
Sofa 298 cm

CL298

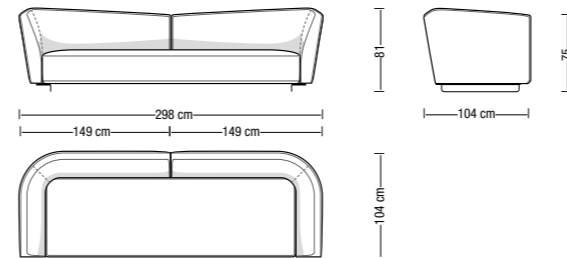

Terminale/Angolare da 149 cm
Terminal/Corner element 149 cm

CL149S

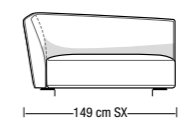

CL149D

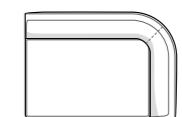
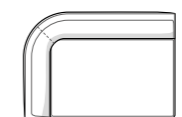
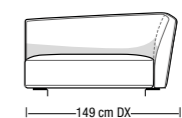

Terminale da 183 cm
Terminal element 183 cm

CL183S

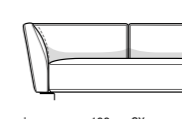

CL183D

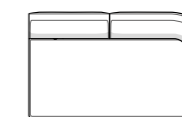
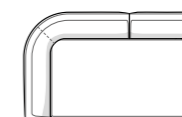
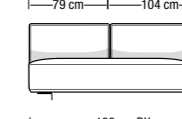

Terminale da 205 cm
Terminal element 205 cm

CL205S

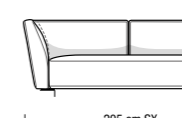

CL205D

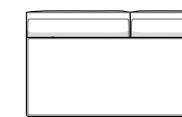
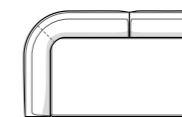

Terminale da 228 cm schienale Basso
Terminal element 228 cm Low backrest

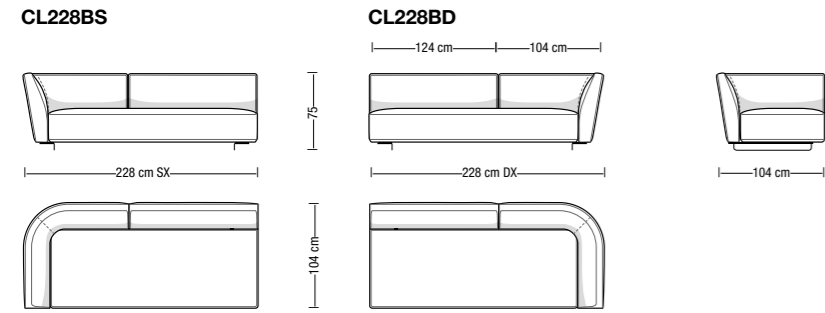

Terminale da 228 cm schienale Alto
Terminal element 228 cm High backrest

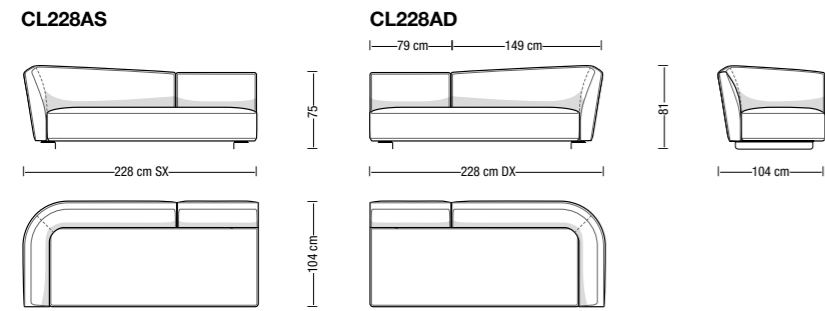

Terminale da 273 cm
Terminal element 273 cm

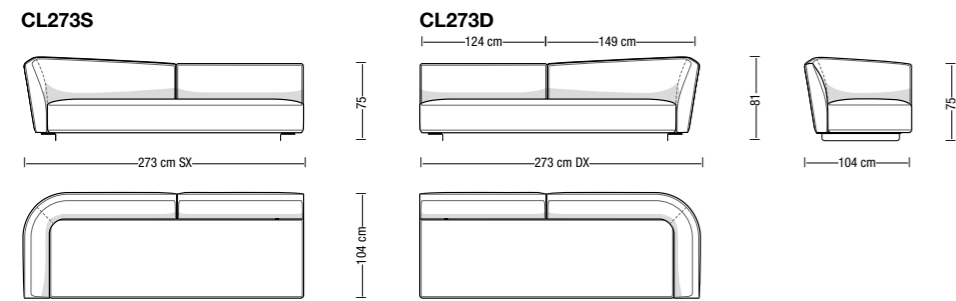

Terminale con penisola da 183 cm
Open-end element 183 cm

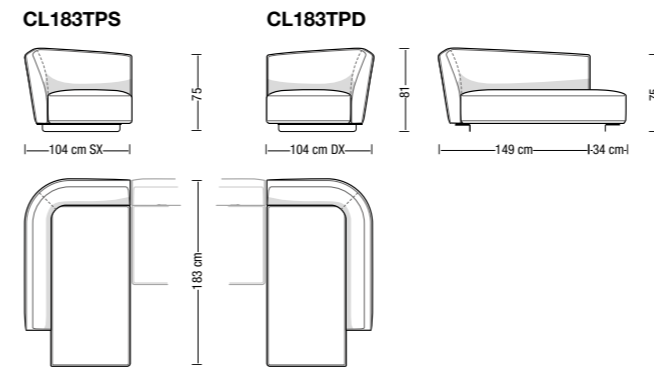

Terminale con penisola da 273 cm
Open-end element 273 cm

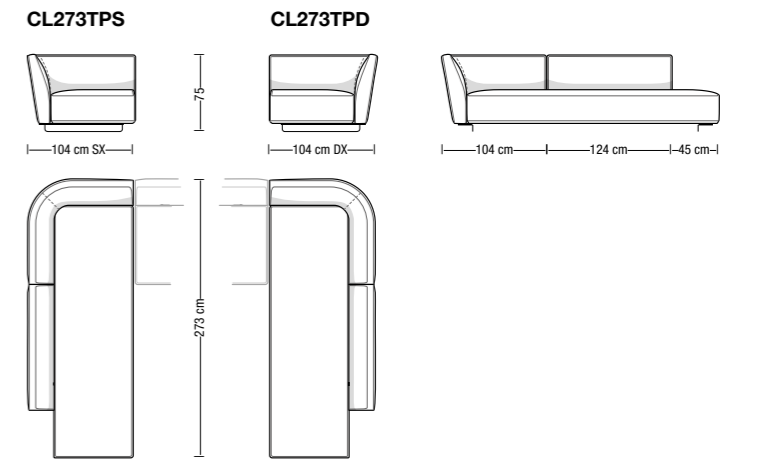

Terminale con penisola da 205 cm
Open-end element 205 cm

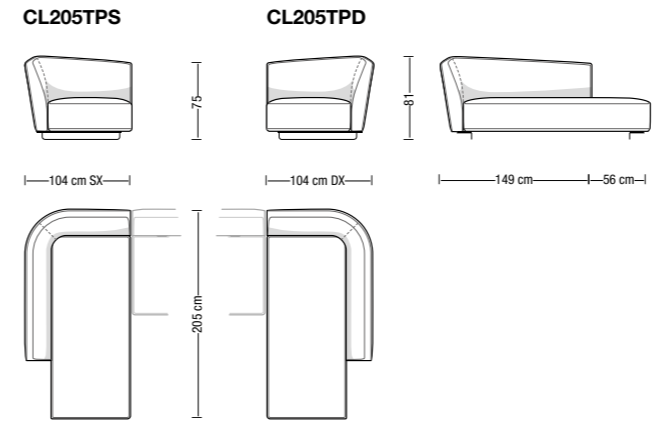

Chaise longue da 149x164 cm
Chaise longue 149x164 cm

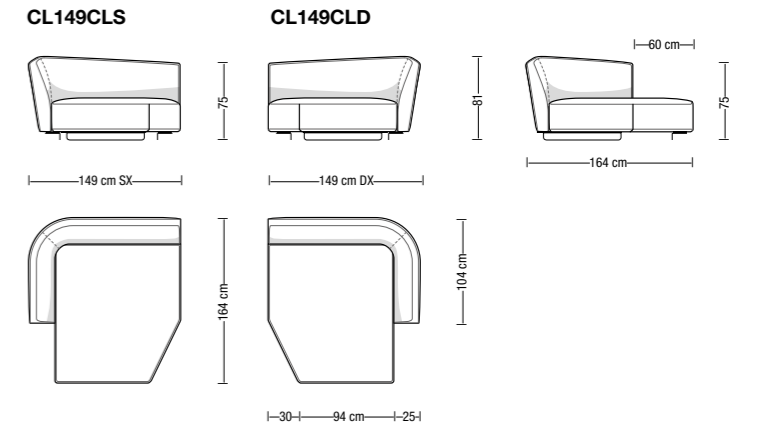

Terminale con penisola da 228 cm
Open-end element 228 cm

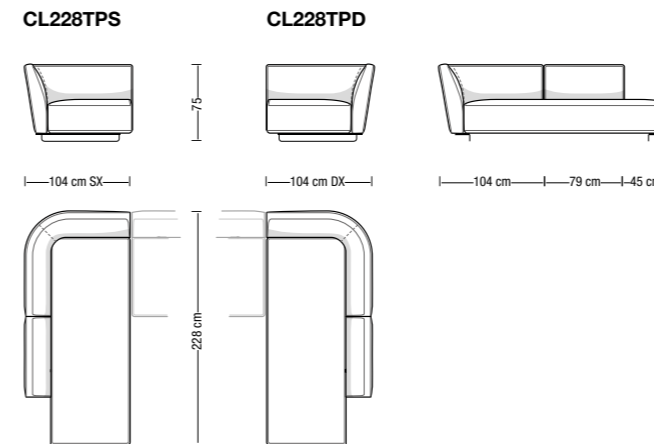

Angolare da 104x104 cm
Corner element 104x104 cm

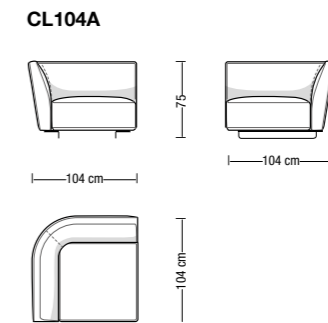

Elemento centrale da 101 cm
Central element 101 cm

CL101EC

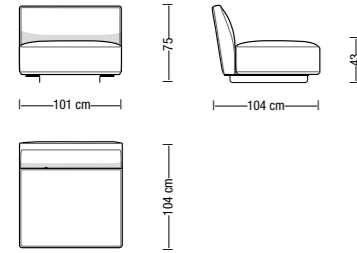

Elemento centrale da 124 cm
Central element 124 cm

CL124EC

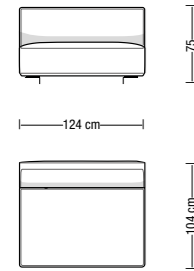

Elemento centrale da 158 cm
Central element 158 cm

CL158EC

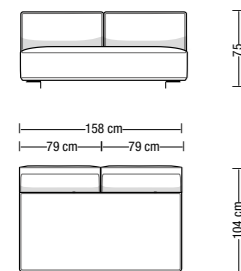

Elemento centrale da 202 cm
Central element 202 cm

CL202EC

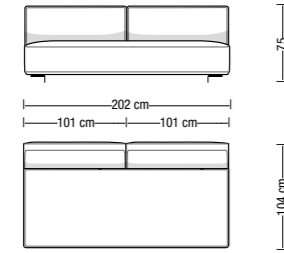

Elemento centrale da 248 cm
Central element 248 cm

CL248EC

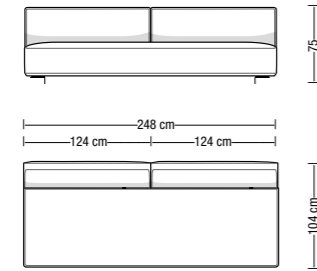

Pouf Cloud
Cloud ottomans

Pouf da 79x79 cm
Ottoman 79x79 cm

CL79X79P

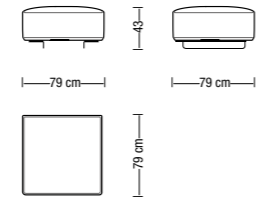

Pouf da 79x101 cm
Ottoman 79x101 cm

CL79X101P

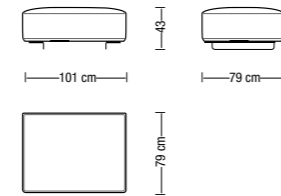

Pouf abbinabili a Cloud
Ottomans matchable with Cloud

Pouf Love 63 cm
Ottoman Love 63 cm

LV63P

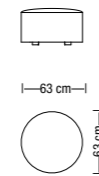

Pouf Love 83 cm
Ottoman Love 83 cm

LV83P

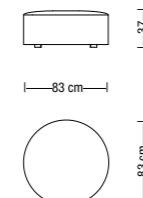

Cuscini - Schienali
Backrest Cushions

Cuscino schienale poggiatesta
Backrest cushion with headrest

CLS58PT

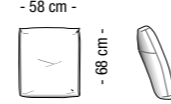

Cuscino schienale
Backrest cushion

CLS63

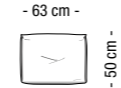

Cuscino 45x45
Cushion 45x45

CLC45

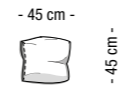

Poggiareni
Lumbar rest

CLP

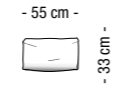

Composizioni suggerite
Compositions suggested

CL1 253x104 cm

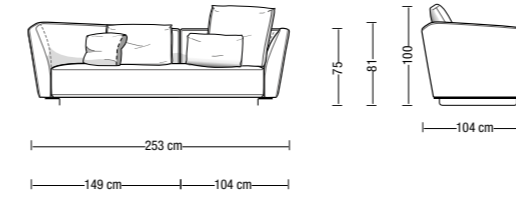

CL3 287x183 cm

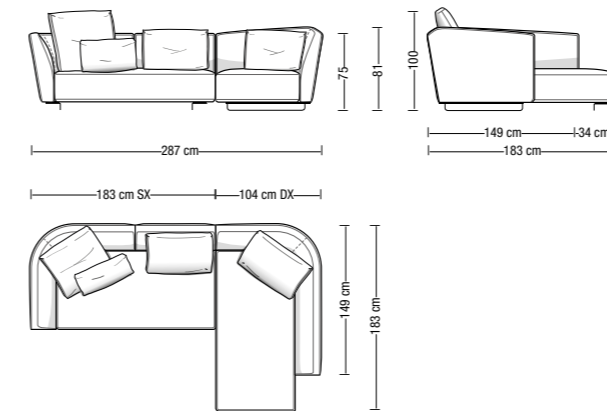

CL5 354x164 cm

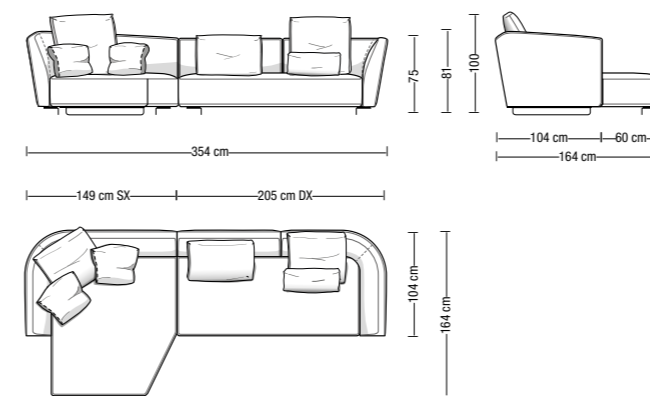

CL2 298x104 cm

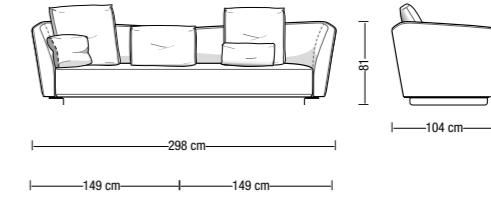

CL4 309x205 cm

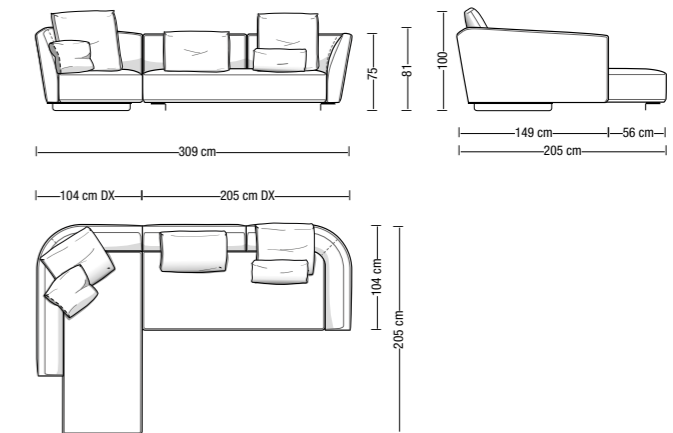

CL6 377x228 cm

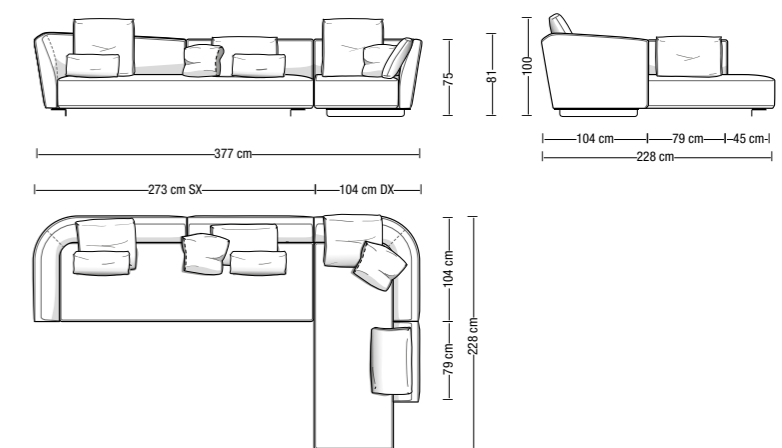

Struttura portante: in legno massello e multistrato monoscocca con molleggio garantito da cinghie elastiche ad alta componente di caucciù.

Preparazione della struttura, versione HI-TEX: in poliuretano espanso a quote differenziate ad alta densità e resilienza. Ulteriore rivestimento della struttura in microfibra "Hi-tex", imbottitura di ultima generazione, ad alto fattore di comfort, certificata OEKO-TEX STANDARD 100, ignifuga, 100% riciclabile.

Preparazione della struttura, versione MEMOSOFF: in poliuretano espanso a quote differenziate ad alta densità e resilienza. Layer superiore di seduta in poliuretano espanso speciale MEMOSOFF. Ulteriore rivestimento della struttura in microfibra "Hi-tex", accoppiata con vellutino.

Schienali mobili: realizzati con 3 differenti parti in poliuretano sagomate a controllo numerico, a densità differenziata, ad alta resilienza. All'interno dell'assemblaggio delle imbottiture è predisposta una lastra d'acciaio che equilibra il manufatto. Ulteriore rivestimento dello schienale con fibra di poliestere termolegata, accoppiata con vellutino. Alla base dello schienale è predisposto, unito al rivestimento, uno speciale elastomero di derivazione nautica che permette l'ancoraggio per attrito.

Braccioli mobili: realizzati in poliuretano a densità differenziata. All'interno dell'assemblaggio delle imbottiture è predisposta una lastra d'acciaio che equilibra il manufatto. Ulteriore rivestimento del bracciolo con fibra di poliestere termolegata accoppiata con vellutino. Alla base del bracciolo è predisposto, unito al rivestimento, uno speciale elastomero di derivazione nautica che permette l'ancoraggio per attrito.

Cuscini schienale: totalmente imbottiti in microfibra "Hi-tex" canalizzata di ultima generazione.

Sfoderabilità: rivestimento sfoderabile in tutte le versioni (tessuto e nabuk).

Basamento: speciali piedi arretrati in ABS con gomma antiscivolo che permettono il posizionamento delle composizioni divani senza ganci o connessioni fra gli elementi.

Structure: in solid wood and plywood, monocoque with high natural rubber content elastic strap webbing.

Preparation of the seat HI-TEX version: in high resilience variable-density polyurethane foam. Outer covering with "Hi-tex" microfiber, innovative padding, certificated OEKO-TEX STANDARD 100, fire resistant, 100% recyclable.

Preparation of the seat, MEMOSOFF version: in high resilience variable-density polyurethane foam. Upper layer with special polyurethane foam MEMOSOFF. Outer covering with "Hi-TEX" microfiber laminated to technical fiber.

Movable backrest: made with 3 different high resilience polyurethane parts shaped under numerical control. Backrest construction has inside a metal plate. Additional cover in heat-bonded polyester fiber laminated to technical fiber. Thanks to a special nautical elastomer fixed with the cover, backrest attach on the base.

Movable armrest: in variable-density polyurethane foam. Armrest construction has inside a metal plate. An additional cover in heat-bonded polyester fiber laminated to technical fiber. Thanks to a special nautical elastomer fixed with the cover, armrest attach on the base.

Back cushion: channeled "Hi-tex", a last generation microfiber.

Covers: completely removable in all version (fabric and leather)

Base: specials half-hidden ABS feet, non-slip rubber allows to join sofa without junction hook.

FILIPH

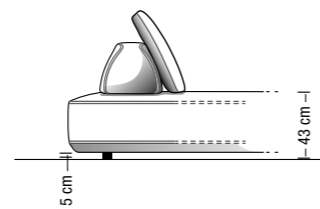
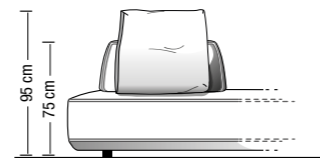

FILIPH HS 45

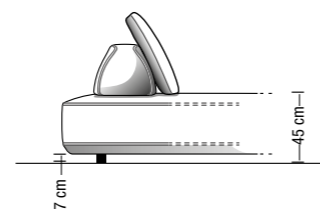
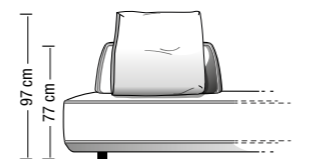

Altezza cuscino orizzontale
Horizontal backrest cushion

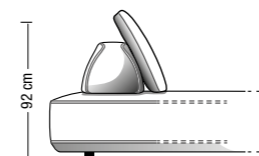

Altezza cuscino poggiatesta
Backrest cushion with headrest

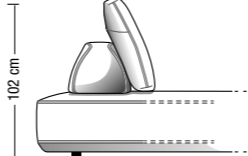

Sono disponibili misure speciali su richiesta. I disegni a catalogo sono da considerarsi suggerimenti di configurazione: schienali e cuscini sono elementi liberamente abbinabili.

Custom-made elements are available on request. Drawings are configuration suggestions: backrests and cushions are freely combinable elements.

Divano da 125 cm
Sofa 125 cm

FL125

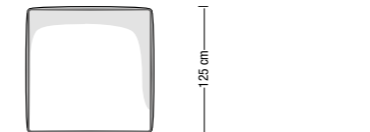
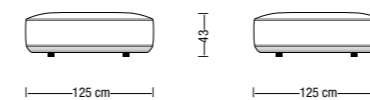

Esempio di disposizione di schienale mobile
Movable backrest placement example

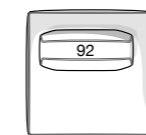

Divano da 175 cm
Sofa 175 cm

FL175

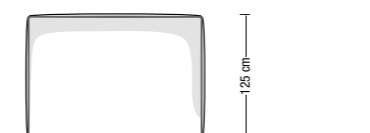

Esempi di disposizione di schienali mobili
Movable backrests placement examples

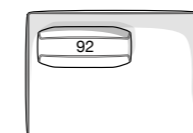
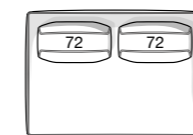

Divano da 195 cm
Sofa 195 cm

FL195

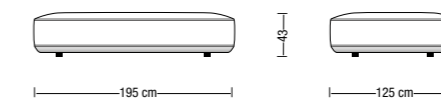

Esempi di disposizione di schienali mobili
Movable backrests placement examples

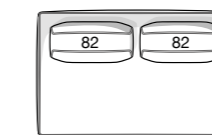
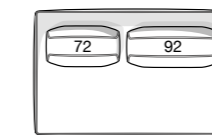

Divano da 225 cm
Sofa 225 cm

FL225



Esempio di disposizione di schienali mobili
Movable backrests placement example



Divano da 255 cm
Sofa 255 cm

FL255

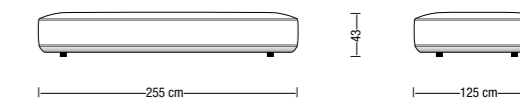

Esempi di disposizione di schienali mobili
Movable backrests placement examples

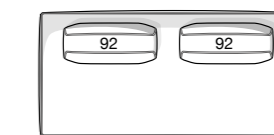
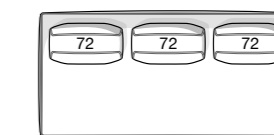

Divano da 285 cm
Sofa 285 cm

FL285

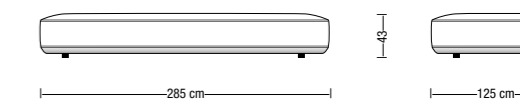

Esempi di disposizione di schienali mobili
Movable backrests placement examples



Pouf / Divano da 125x85 cm
Ottoman / Sofa 125x85 cm

FL85

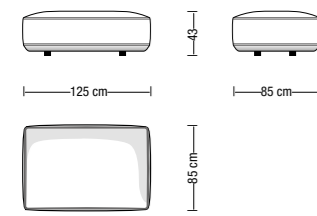

Esempio di disposizione di schienale mobile
Movable backrest placement example



Divano da 110x110 cm
Sofa 110x110 cm

FL110X

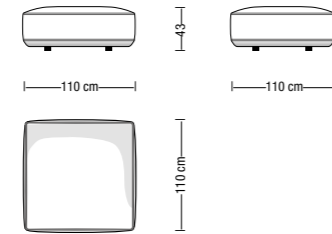

Esempio di disposizione di schienale mobile
Movable backrest placement example

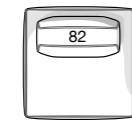

Divano da 175x110 cm
Sofa 175x110 cm

FL175X

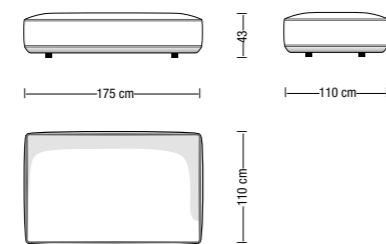

Esempi di disposizione di schienali mobili
Movable backrests placement examples

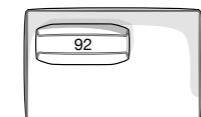
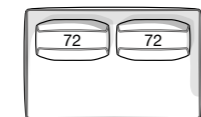

Divano da 195x110 cm
Sofa 195x110 cm

FL195X

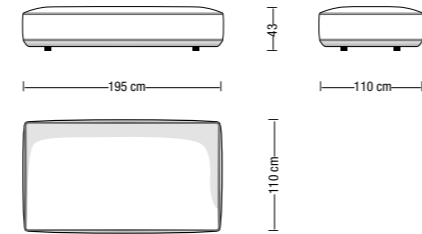

Esempi di disposizione di schienali mobili
Movable backrests placement examples

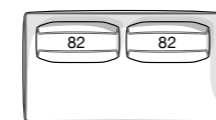
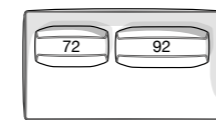

Divano da 225x110 cm
Sofa 225x110 cm

FL225X

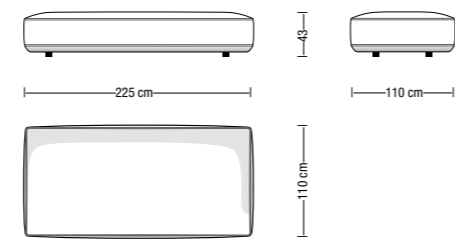

Esempio di disposizione di schienali mobili
Movable backrests placement example



Divano da 255x110 cm
Sofa 255x110 cm

FL255X

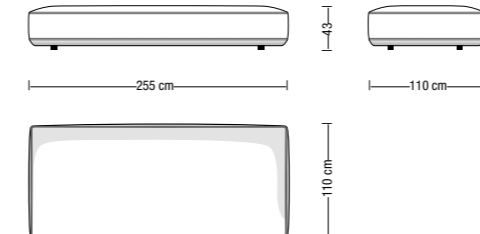

Esempi di disposizione di schienali mobili
Movable backrests placement examples



Pouf / Divano da 110x85 cm
Ottoman / Sofa 110x85 cm

FL85X

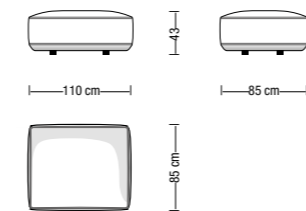

Esempio di disposizione di schienale mobile
Movable backrest placement example



Divano Pentagonale
Pentagonal Sofa

FL5

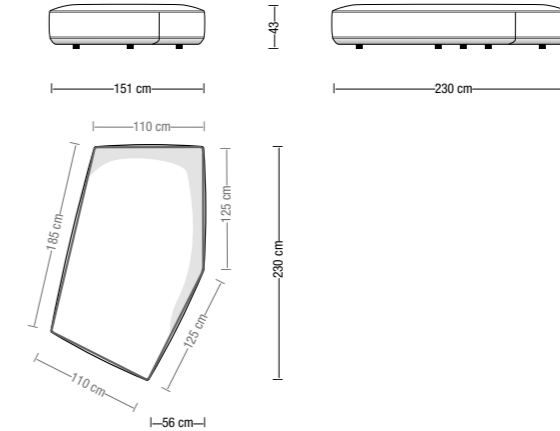

Configurazioni divano pentagonale ed esempi di disposizioni schienale mobile
Pentagonal sofa layouts and movable backrest placement example

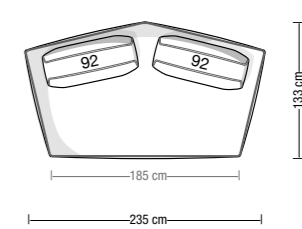
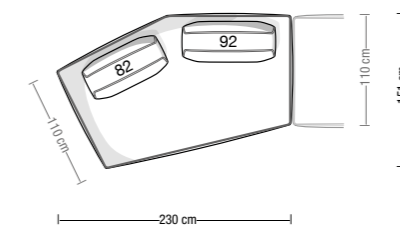
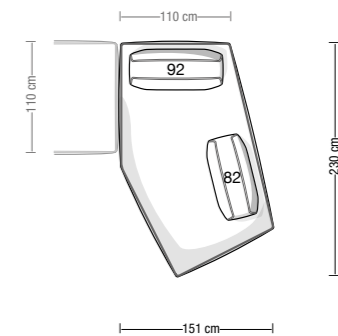
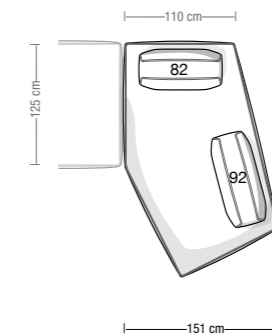

Schienali mobili
Movable backrests

Schienale mobile 72
Movable backrest 72

FLM72

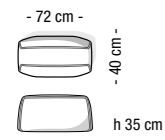

Schienale mobile 82
Movable backrest 82

FLM82

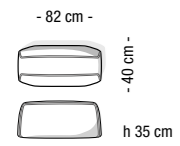

Schienale mobile 92
Movable backrest 92

FLM92

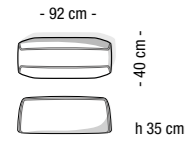

Schienale mobile 122V
Movable backrest 122V

FLM122V

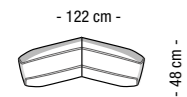

Cuscini - Schienali
Backrest cushions

Cuscino schienale poggiatesta
Backrest cushion headrest

FLSPT

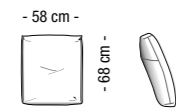

Cuscino schienale orizzontale
Horizontal backrest

FLSO

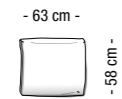

Cuscino schienale verticale
Vertical backrest

FLSV

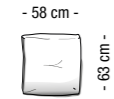

Cuscino schienale verticale con rullo
Vertical backrest with headrest bolster

FLSVR

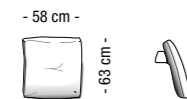

Poggiareni
Lumbar rest

FLP

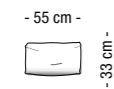

Accessori ergonomici
Ergonomics accessories

Bracciolo mobile
Movable armrest

FLB

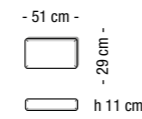

Rullo indipendente per schienale verticale
Headrest bolster for vertical cushion

FLR

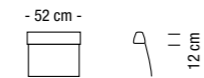

Rullo abbinabile con FLSV
Bolster matchable with FLSV

Pouf abbinabili a Filiph
Ottomans matchable with Filiph

Pouf Love 63 cm
Ottoman Love 63 cm

LV63P

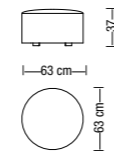

Pouf Love 83 cm
Ottoman Love 83 cm

LV83P

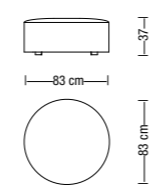

Pouf Filiph Air da 63x53 cm
Ottoman Filiph Air 63x53 cm

FA63X53

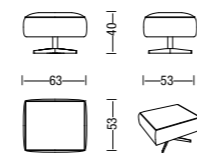

Composizioni suggerite
Compositions suggested

C1 da 300x175 cm

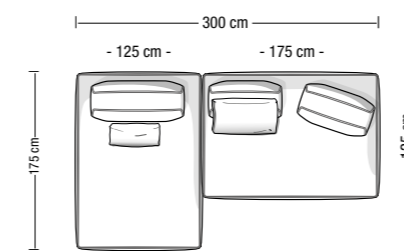

C3 da 225x125 cm

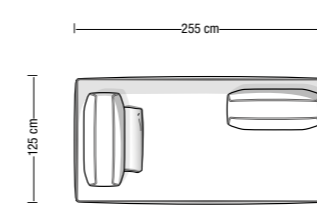

C5 da 320x225 cm

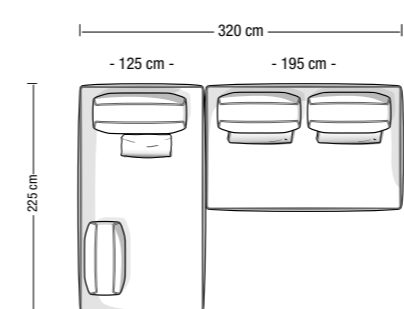

C7 da 225X125 cm + 225X125 cm

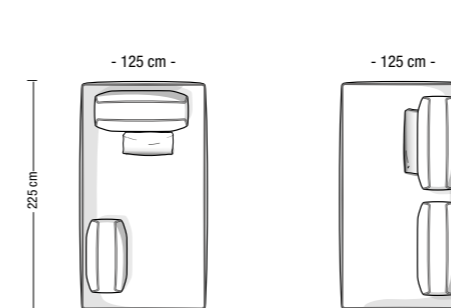

C2 da 320x195 cm

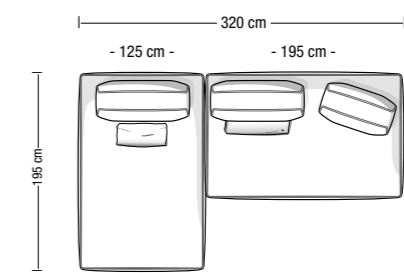

C4 da 285x210 cm

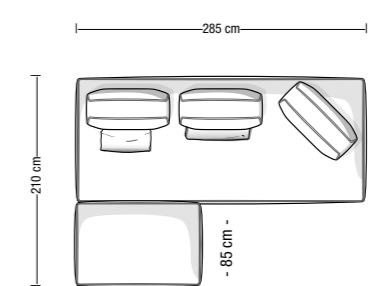

C6 da 350x225 cm

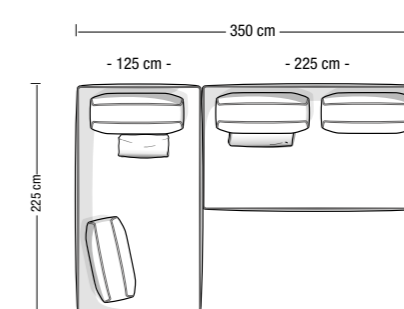

C8 da 350x320 cm

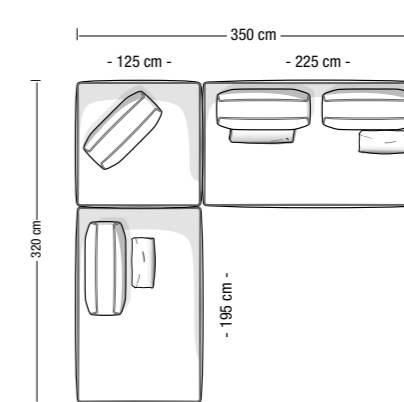

Composizioni suggerite con elementi a profondità 110cm
 Compositions suggested with 110cm depth elements

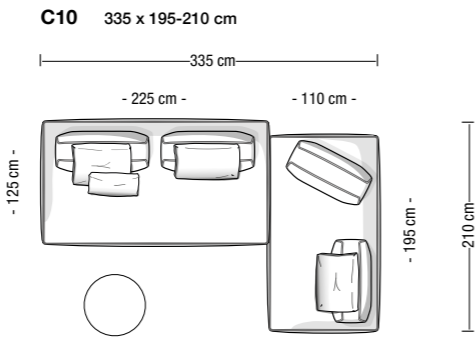
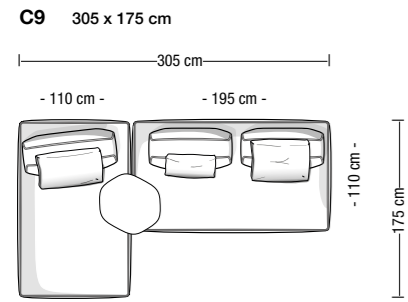

Composizioni suggerite con elemento pentagonale
 Compositions suggested with pentagonal sofa

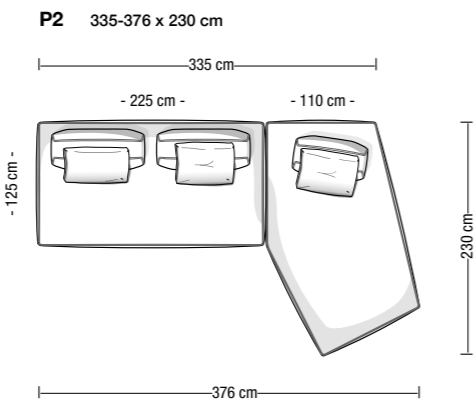
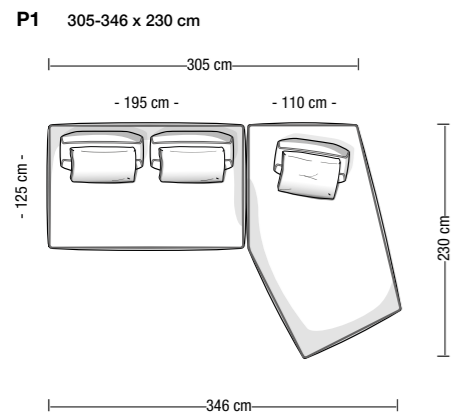

Composizioni suggerite con elemento pentagonale
 Compositions suggested with pentagonal sofa

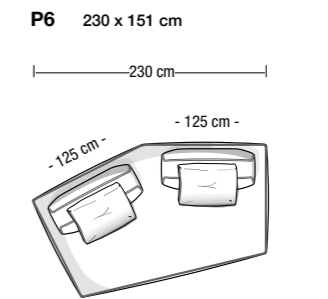
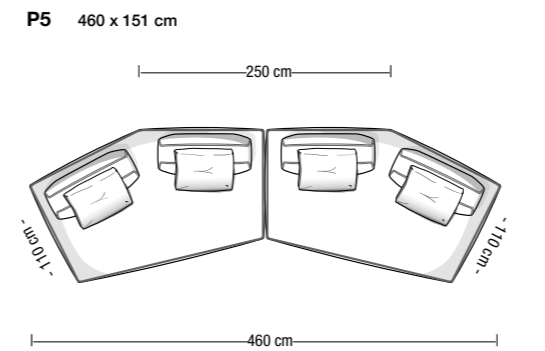
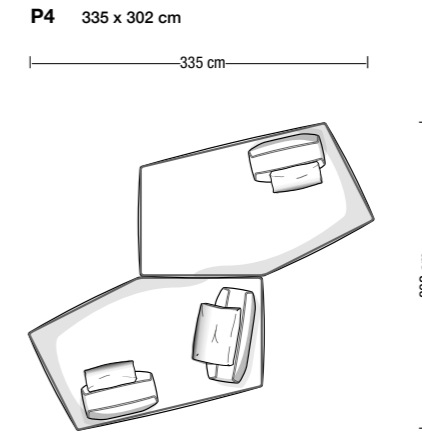
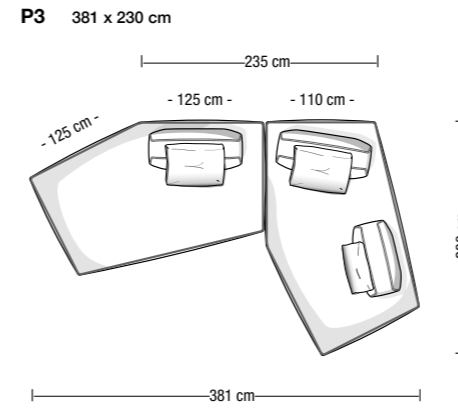

Struttura portante: in legno multistrato marino monoscocca con molleggio garantito da cinghie elastiche ad alta componente di caucciù.

Preparazione della struttura: in poliuretano espanso ad alta densità e resilienza ignifugo e anti muffa. Rivestimento della struttura con falda di microfibra "Hi-tex" di ultima generazione, ad alto fattore di comfort, certificata OEKO-TEX STANDARD 100, ignifuga, 100% riciclabile. Ulteriore rivestimento con tessuto elasticizzato impermeabile, anallergico, con trattamento anti batterico, anti funghi e anti muffe. Il fondo della struttura è rivestito con una membrana traspirante e impermeabile, e fissato con punti in acciaio inox.

Schienali mobili: realizzati con 3 differenti parti in poliuretano sagomate a controllo numerico, a densità differenziata, ad alta resilienza: il fondo è realizzato in una speciale schiuma microcellulare a cellula aperta che non permette la risalita dell'acqua. All'interno dell'assemblaggio delle imbottiture è predisposta una lastra d'acciaio verniciata a polvere che equilibra il manufatto. Ulteriore rivestimento con tessuto elasticizzato impermeabile, anallergico, con trattamento anti batterico, anti funghi e anti muffe abbinato ad una membrana traspirante e impermeabile sul fondo. Alla base dello schienale è predisposto, unito al rivestimento, uno speciale elastomero di derivazione nautica che permette l'ancoraggio per attrito.

Cuscini schienale: totalmente imbottiti in microfibra "Hi-tex" canalizzata di ultima generazione con rivestimento in tessuto impermeabile per esterno.

Sfoderabilità: rivestimento completamente sfoderabile.

Basamento: speciali piedi arretrati in ABS con gomma antiscivolo che permettono il posizionamento delle composizioni divani senza ganci o connessioni fra gli elementi.

Rivestimenti: per un utilizzo open-air ed outdoor dei divani si consigliano tessuti specificamente studiati per l'esterno.

Structure: in marine plywood mono-coque with high natural rubber content elastic strap webbing.

Preparation of the seat: in high resilience polyurethane foam, fireproof and anti-mold. Outer covering with "Hi-tex" microfiber, innovative padding certificated OEKO-TEX STANDARD 100, fire resistant, 100% recyclable. Additional covering made by waterproof elastic fabric, antifungal, anti-mold and with antibacterial treatment. The bottom side of the structure is close by a water repellent and breathable membrane fixed with stainless steel staples.

Movable backrest: made with 3 different high resilience polyurethane parts shaped under numerical control: the bottom is made in a special microcellular foam with open cells that doesn't allow capillary water rising. Backrest construction has inside a powder coating metal plate. Additional cover made by waterproof elastic fabric, antifungal, anti-mold and with antibacterial treatment. Thanks to a special nautical elastomer fixed with the cover, backrest attach on the base.

Back cushion: channeled "Hi-tex", a last generation microfiber, outer covered with water repellent outdoor fabric.

Covers: completely removable in all versions. For outdoor or open-air use of the sofas, it's advisable to choose outdoor fabrics.

Base: specials half-hidden ABS feet, non-slip rubber allows to join sofa without junction hook.

FILIPH OUTDOOR

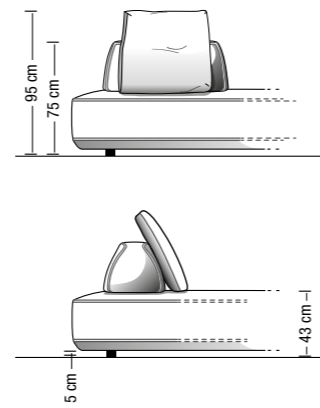

Divano da 125 cm Outdoor
Sofa 125 cm Outdoor

FO125

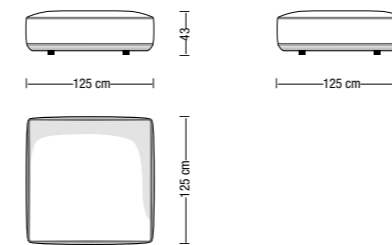

Esempio di disposizione di schienale mobile
Movable backrest placement example

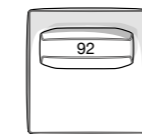

Divano da 225 cm Outdoor
Sofa 225 cm Outdoor

FO225

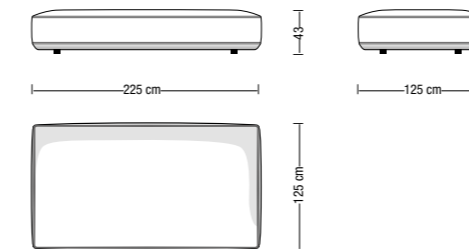

Esempio di disposizione di schienali mobili
Movable backrests placement example



Divano da 175 cm Outdoor
Sofa 175 cm Outdoor

FO175

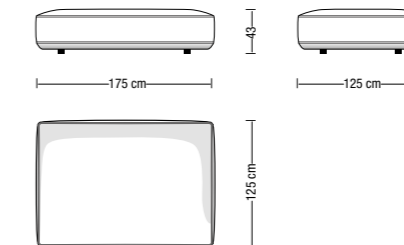

Esempi di disposizione di schienali mobili
Movable backrests placement examples

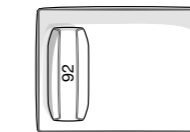
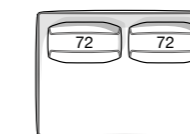

Schienali mobili per outdoor
Outdoor movable backrests

Schienale mobile 72 per outdoor
Outdoor movable backrest 72

FOM72

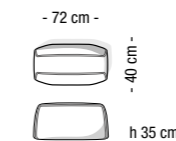

Schienale mobile 82 per outdoor
Outdoor movable backrest 82

FOM82

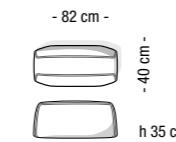

Schienale mobile 92 per outdoor
Outdoor movable backrest 92

FOM92

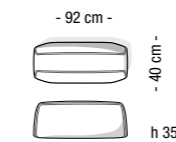

Divano da 195 cm Outdoor
Sofa 195 cm Outdoor

FO195

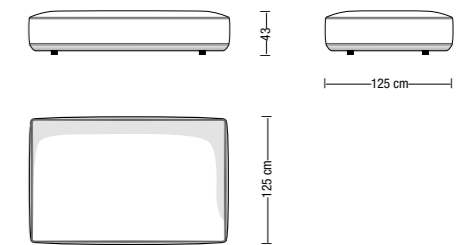

Esempi di disposizione di schienali mobili
Movable backrests placement examples

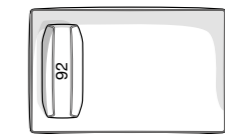

Cuscini schienale per outdoor
Outdoor backrest cushions

Cuscino schienale orizzontale per outdoor
Outdoor horizontal backrest

FOSO

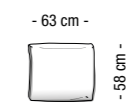

Cuscino schienale verticale per outdoor
Outdoor vertical backrest

FOSV

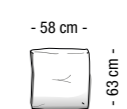

Poggiareni per outdoor
Outdoor lumbar rest

FOP

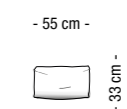

Struttura portante: in legno massello e multistrato con molleggio garantito da cinghie elastiche ad alta componente di caucciù.

Preparazione della struttura: in poliuretano espanso a quote differenziate ad alta densità e resilienza sagomate a controllo numerico. Seduta in poliuretano espanso ad alta densità e resilienza, con rivestimento in ovatta di poliestere siliconata ad alto spessore. Ulteriore rivestimento della struttura con fibra di poliestere termolegata accoppiata con vellutino.

Cuscini schienale: totalmente imbottiti in piuma d'oca canalizzata certificata "Assopiuma etichetta Oro". Cuscini ornamentali in piuma d'oca canalizzata certificata "Assopiuma".

Sfoderabilità: versione in tessuto, previo smontaggio degli schienali. Fisso nella versione in pelle. Cuscini di schienale sempre sfoderabili.

Basamenti: piedi arretrati in legno massello.

Poggiatesta opzionali: schienalini indipendenti e spostabili in acciaio rivestito in pelle o in cuoio ecologico disponibile nelle finiture a campionario.

Structure: in solid wood and plywood, with high natural rubber content elastic strap webbing.

Preparation of the seat: in high resilience variable-density polyurethane foam. Seat in high resilience polyurethane foam covered with a high depth polyester silicon fiber. Outer covering with heat-bonded polyester fiber laminated to technical fiber.

Backrest cushion: channeled goose down, (Certified Assopiuma, gold label). Ornamental cushion: channeled goose down, certified "Assopiuma"

Covers: completely removable in fabric version, after disassembly of the backrest structure. Fixed in leather version. Backrest cushion covers are completely removable.

Base: half-hidden solid wood feet painted.

Optional headrest: movable metal backrest covered with leather or ecologic leather as available colors.

OLTRE

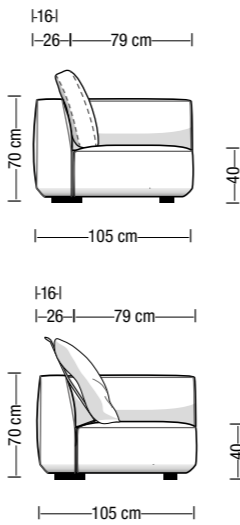

Esempi di disposizione alternativa cuscini schienale
Examples of alternative backrest cushions setup

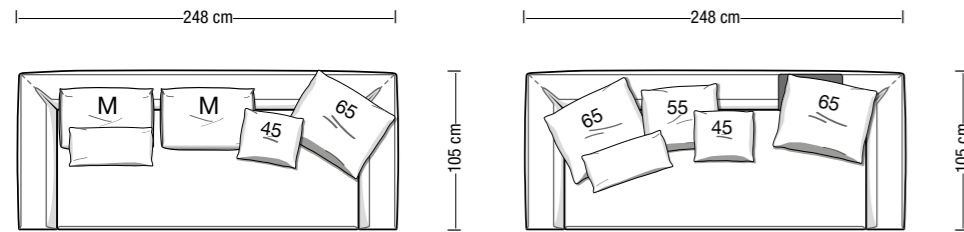

Schienale M Backrest M	Schienale L Backrest L	Cuscino 45x45 Cushion 45x45	Cuscino 55x55 Cushion 55x55	Cuscino 65x65 Cushion 65x65	Poggiareni Lumbar rest
OLSM	OLSL	OLC45	OLC55	OLC65	OLP

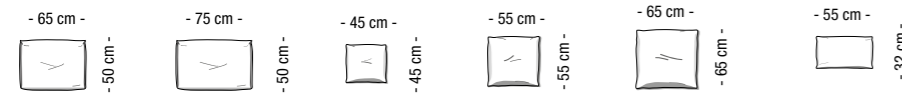

Schienalino di supporto
in metallo e pelle
Leather and steel backrest
SUP



Sono disponibili misure speciali su richiesta.
I disegni a catalogo sono da considerarsi suggerimenti di configurazione:
schienali e cuscini sono elementi liberamente abbinabili.

Custom-made elements are available on request.
Drawings are configuration suggestions:
backrests and cushions are freely combinable elements.

Divano a 1 bracciolo da 145 cm
Element with 1 armrest 145 cm

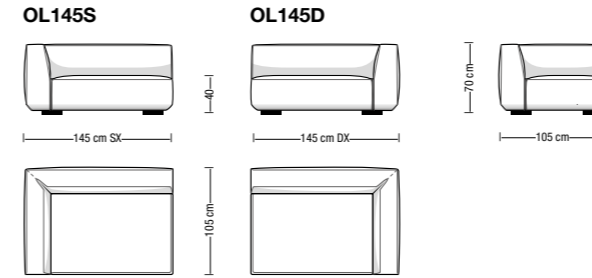

Divano a 1 bracciolo da 165 cm
Element with 1 armrest 165 cm

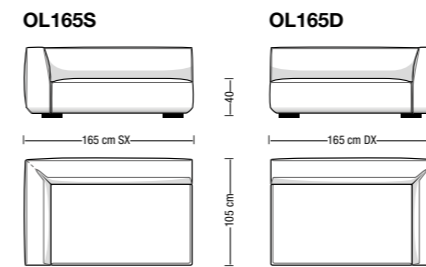

Divano a 1 bracciolo da 185 cm
Element with 1 armrest 185 cm

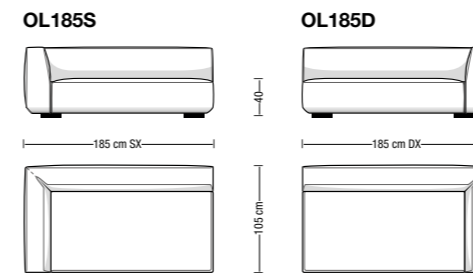

Divano a 1 bracciolo da 205 cm
Element with 1 armrest 205 cm

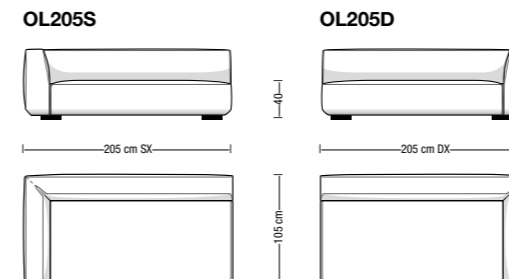

Divano a 1 bracciolo da 225 cm
Element with 1 armrest 225 cm

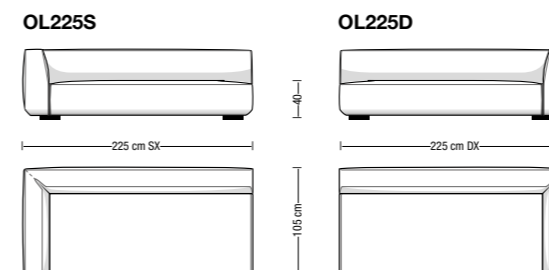

Divano da 188 cm
Sofa 188 cm

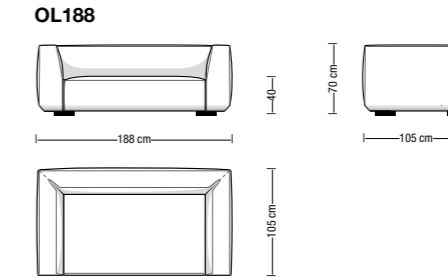

Divano da 208 cm
Sofa 208 cm

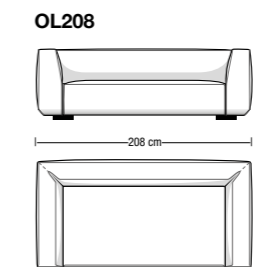

Divano da 228 cm
Sofa 228 cm

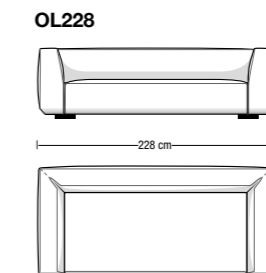

Divano da 248 cm
Sofa 248 cm

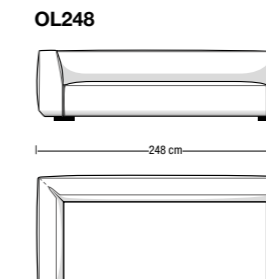

Poltrona/Elemento centrale da 105 cm
Armchair/Central element 105 cm

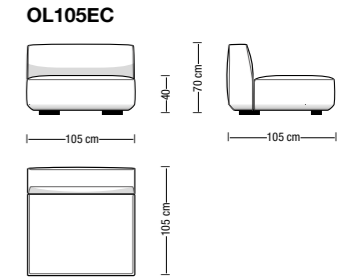

Poltrona/Elemento centrale da 143 cm
Armchair/Central element 143 cm

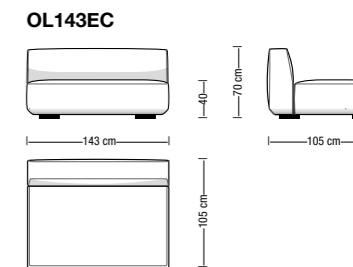

Pouff da 105x105 cm
Ottoman 105x105 cm

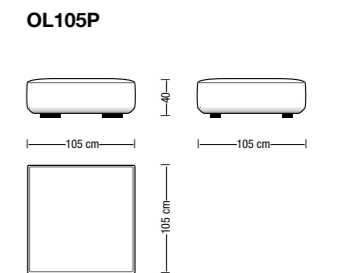

Pouff da 143x83 cm
Ottoman 143x83 cm

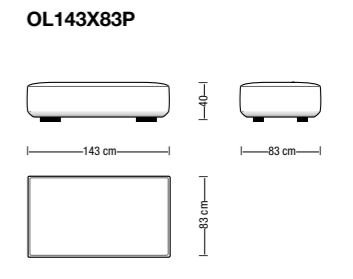

Pouff da 163x83 cm
Ottoman 163x83 cm

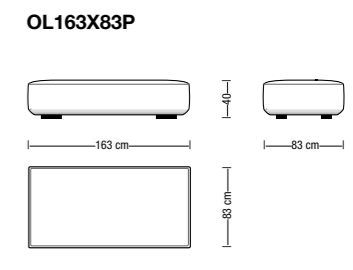

Struttura portante: in legno massello e multistrato con molleggio garantito da cinghie elastiche ad alta componente di caucciù.

Preparazione della struttura: in poliuretano espanso a quote differenziate ad alta densità e resilienza. Ulteriore rivestimento della struttura con fibra di poliestere termolegata di forte spessore, accoppiata con vellutino.

Cuscineria: imbottitura cuscino in "Memofill" canalizzato (particelle di poliuretano viscoelastico termosensibile e innovativa microfibra "Hi-tex") con inserto centrale in poliuretano ad alta resilienza. In alternativa: sedile in poliuretano espanso speciale "Polilatex", con rivestimento in ovatta di poliestere siliconata ad alto spessore, accoppiata con tela di cotone bianca. In alternativa ulteriore: cuscino in piuma canalizzata con inserto centrale in poliuretano ad alta resilienza.

Cuscini schienale: totalmente imbottiti in piuma d'oca canalizzata certificata "Assopiuma etichetta oro" con poggiareni integrato in fiocchi di fibra di poliestere, rivestimento supplementare in ovatta di poliestere ad alto spessore accoppiata con tela di cotone bianca per nascondere i segni della piuma.

Sfoderabilità: rivestimento sfoderabile nella versione in tessuto, fisso nella versione in pelle. Cuscini di seduta e schienale sempre sfoderabili.

Basamenti: piedi arretrati in legno massello. Basamento opzionale in metallo pressofuso ed estruso, disponibile nelle versioni: cromo, satinato, antracite o colori speciali (versione SQUARE LINE STEEL).

Poggiatesta: supporto in poliuretano espanso ad alta densità rivestito con fibra di poliestere termolegata di forte spessore, accoppiata con vellutino.

In alternativa: schienalino indipendente e spostabile in acciaio rivestito in pelle o in cuoio ecologico disponibile in svariate colorazioni.

Tavolini opzionali: indipendenti e spostabili in acciaio rivestito in pelle o in cuoio ecologico, con scivolanti in nylon.

Structure: in solid wood and plywood with high natural rubber content elastic strap webbing.

Preparation of the seat: in high resilience variable-density polyurethane foam. Outer covering with heat-bonded polyester fiber laminated to technical fiber.

Seat Cushions: "Memofill" quilt (heat-sensitive foam and innovative microfiber "Hi-tex" mixed) with high resilience polyurethane foam central insert. Alternative option: "Polilatex" cushion, a special polyurethane high resilience foam covered with a high depth polyester fiber heat-bonded to white cotton canvas. Alternative option: quilted goose down padding cushion with "Polilatex" foam central insert.

Backrest cushion: channeled goose down, (Certified Assopiuma, gold label) complete with a polyester fiber lumbar support insert. Additional cover in polyester fiber and white cotton canvas in order to hide feather signs.

Covers: completely removable in fabric version and fixed in leather version. Seat cushion and backrest cushion covers are completely removable.

Base: half-hidden solid wood feet. Optional perimeter frame in extruded and die-cast metal available chrome, satin, painted anthracite or special edition colors (SQUARE LINE STEEL version).

Headrest: support in high density polyurethane, covered with heat-bonded polyester fiber laminated to technical fiber.

Headrest, alternative option: movable metal backrest covered with leather or ecologic leather.

Optional coffee tables: in steel covered with leather or ecologic leather, nylon protective glides.

SQUARE LINE VENTICINQUE SQUARE LINE con larghezza bracciolo/schienale da 25 cm 25 cm armrest/backrest SQUARE LINE version

Disponibile in due profondità: 104 cm o 111 cm
2 depths available: 104 cm or 111 cm

Disponibile in due altezze di seduta: 42 o 45 cm
2 sitting heights available: 42 or 45 cm

Disponibile con tre tipi di materiali di seduta:
"Memofill" (soffice), "Piuma" (soffice e mossata), "Polilatex" (rigida)
3 seat cushion material versions available:
"Memofill" (soft), "Feather" (soft and wavy), "Polilatex" (hard)

Profondità seduta con schienale (M / L / XL)
Sitting depth with backrest cushion (M / L / XL)

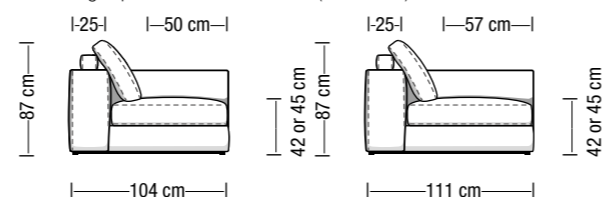

Profondità seduta indicative con cuscino da 60x60cm o 69x69cm
e schienalino di supporto in metallo e pelle
Sitting depth with 60x60cm or 69x69cm backrest cushion
and leather/steel headrest

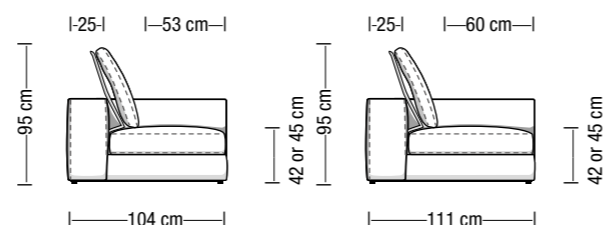

Divano da 220 cm Sofa 220 cm

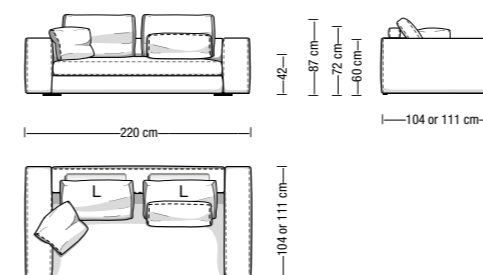

Divano da 256 cm Sofa 256 cm

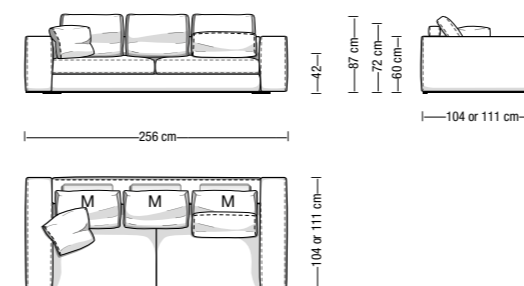

Disposizione alternativa schienali
Alternative backrest cushions layout

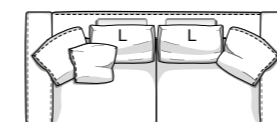

Versione divano a seduta unica
Cuscino di seduta disponibile solo in versione Polilatex
Disposizione alternativa schienali con cuscini morbidi

One-piece seat cushion version
Available only in Polilatex seat cushion version
Alternative backrest cushions layout

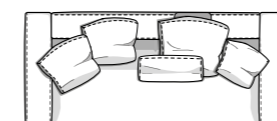

Divano da 294 cm Sofa 294 cm

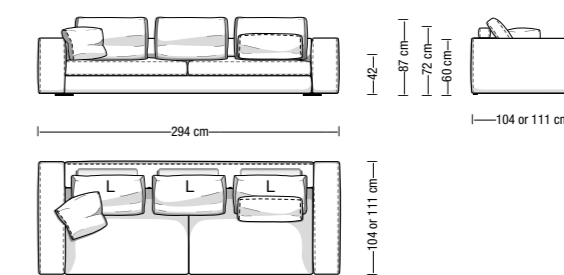

Disposizione alternativa schienali
Alternative backrest cushions layout

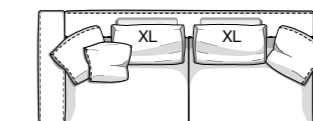

Disposizione alternativa schienali con cuscini morbidi
Alternative backrest cushions layout

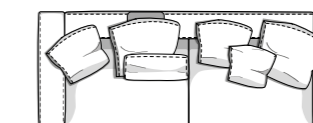

Versione divano a 3 sedute
Three seat cushions version

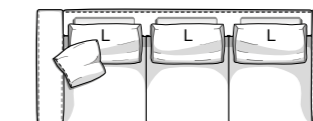

Sono disponibili misure speciali su richiesta.
I disegni a catalogo sono da considerarsi
suggerimenti di configurazione:
schienali e cuscini sono elementi liberamente abbinabili.

Custom-made elements are available on request.
Drawings are configuration suggestions:
backrests and cushions are freely combinable elements.



Divano a 1 bracciolo da 160 cm
Element with 1 armrest 160 cm

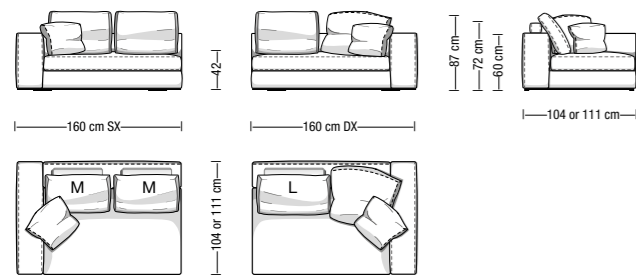

Divano a 1 bracciolo da 231 cm
Element with 1 armrest 231 cm

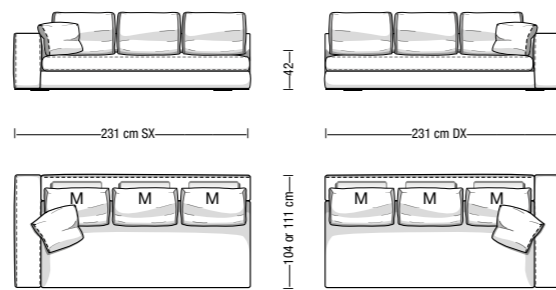

Versione divano a seduta unica, disponibile solo in versione Pollatex
One-piece seat cushion version, available only in Pollatex seat cushion

Versione divano a 2 sedute
Two seat cushions version

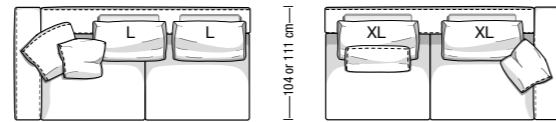

Divano a 1 bracciolo da 180 cm
Element with 1 armrest 180 cm

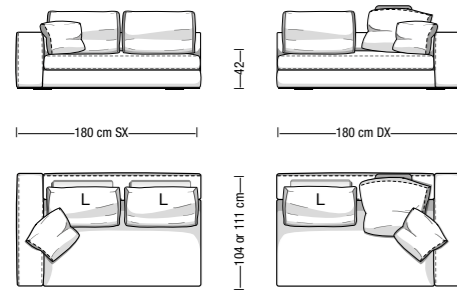

Divano a 1 bracciolo da 269 cm
Element with 1 armrest 269 cm

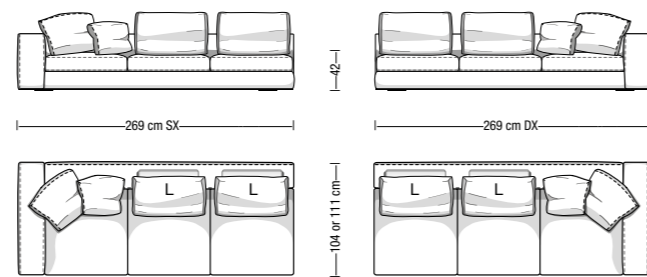

Versione divano a 2 sedute
Two seat cushions version

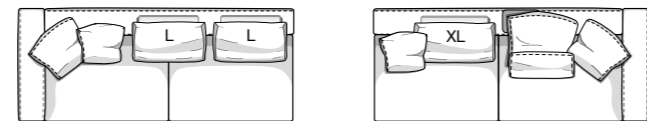

Divano a 1 bracciolo da 195 cm
Element with 1 armrest 195 cm

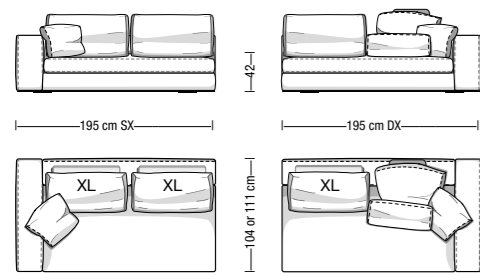

Angolare/Chaise longue da 160 cm
Corner element/Chaise longue 160 cm

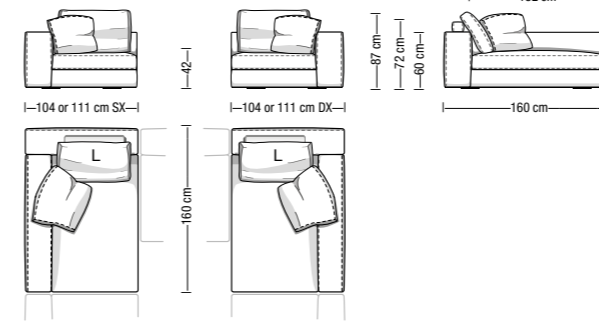

Angolare/Chaise longue da 160 cm
Corner element/Chaise longue 160 cm

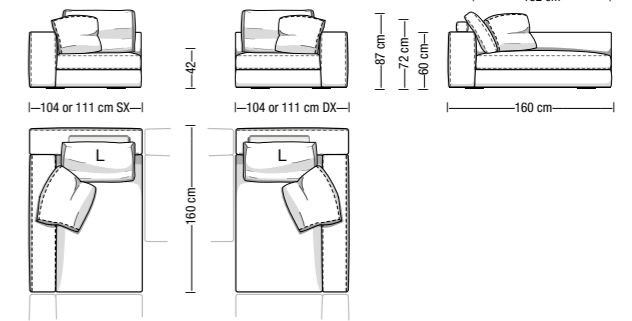

Angolare/Chaise longue da 180 cm
Corner element/Chaise longue 180 cm

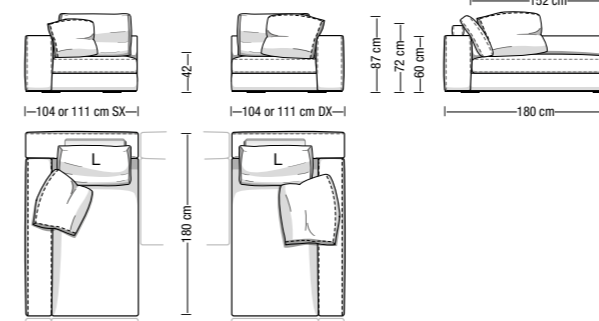

Angolare/Chaise longue da 180 cm
Corner element/Chaise longue 180 cm

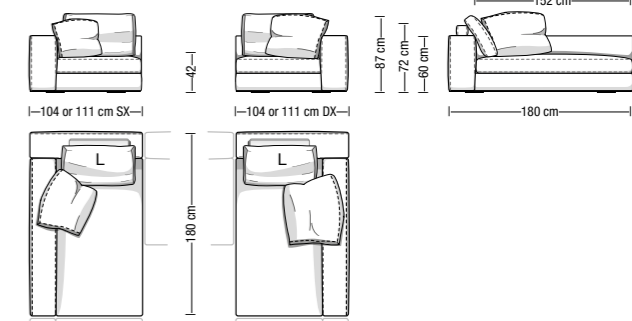

Angolare/Chaise longue da 195 cm
Corner element/Chaise longue 195 cm

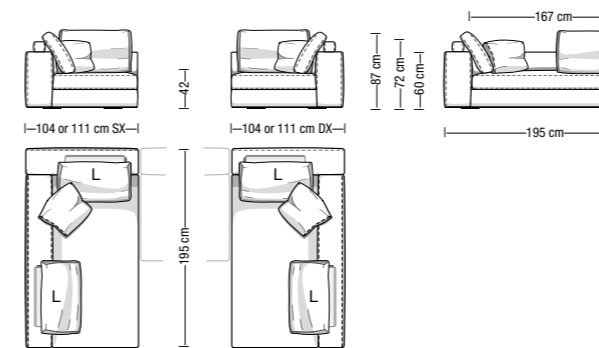

Angolare/Chaise longue da 195 cm
Corner element/Chaise longue 195 cm

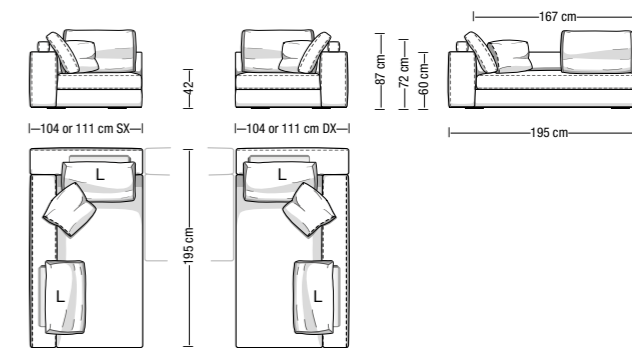

Poltrona terminale con penisola da 125 cm Open-end armchair 125 cm

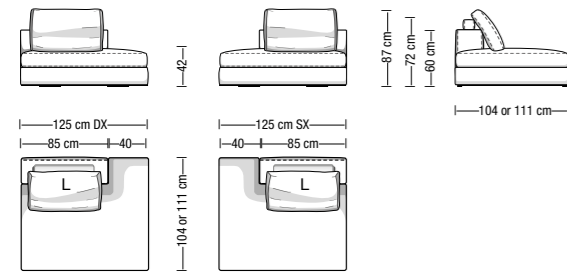

Divano terminale con penisola senza bracciolo da 190 cm Open-end terminal element without armrest 190 cm

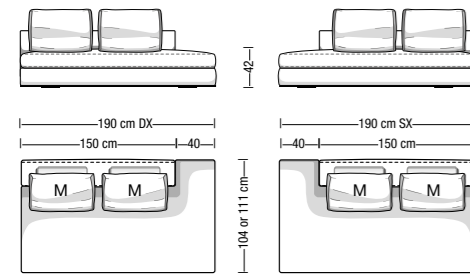

Cuscino di seduta disponibile solo in versione Pollatex
Available only in Pollatex seat cushion version

Divano a 1 bracciolo con penisola da 215 cm Open-end element with 1 armrest 215 cm

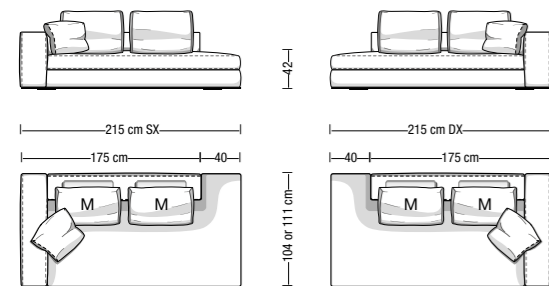

Cuscino di seduta disponibile solo in versione Pollatex
Available only in Pollatex seat cushion version

Chaise longue da 123x175 cm Chaise longue 123x175 cm

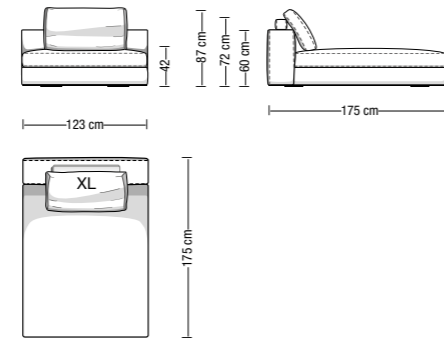

Disposizione alternativa schienali con cuscini morbidi
Alternative backrest cushions layout

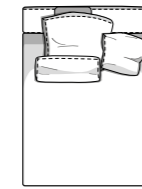

Chaise longue con 1 bracciolo da 148x175 cm Chaise longue with 1 armrest 148x175 cm

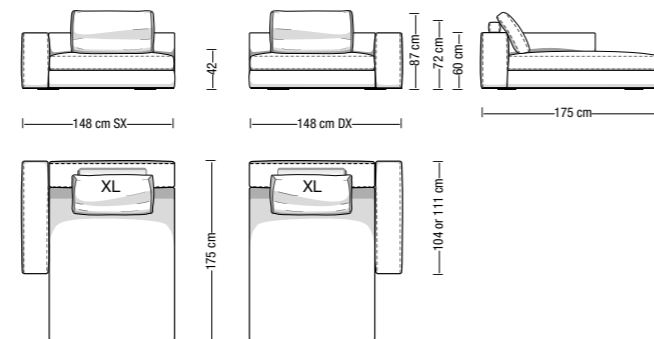

Disposizione alternativa schienali con cuscini morbidi
Alternative backrest cushions layout

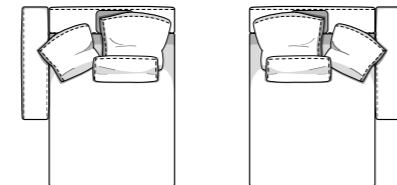

Poltrona/Elemento centrale da 104 cm Armchair/Central element 104 cm

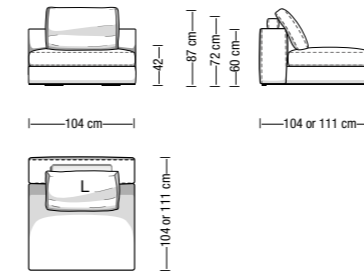

Poltrona/Elemento centrale da 123 cm Armchair/Central element 123 cm

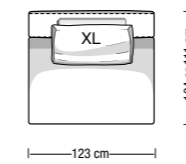

Elemento centrale da 135 cm Central element 135 cm

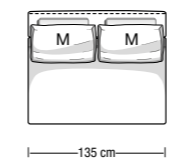

Elemento centrale da 155 cm Central element 155 cm

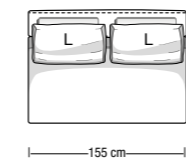

Elemento centrale da 170 cm Central element 170 cm

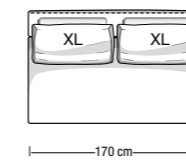

Pouf da 104x78 cm o 104x85 cm Ottoman 104x78 cm or 104x85 cm

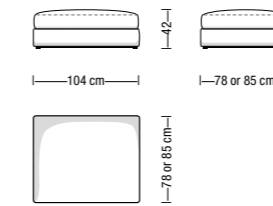

Pouf da 111x78 cm o 111x85 cm Ottoman 111x78 cm or 111x85 cm

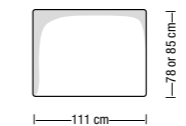

Pouf da 123x78 cm o 123x85 cm Ottoman 123x78 cm or 123x85 cm

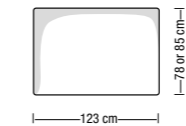

Pouf da 104x104 cm Ottoman 104x104 cm

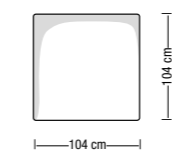

Pouf da 111x111 cm Ottoman 111x111 cm

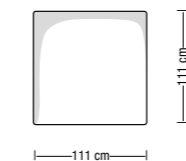

Schienale M Backrest M

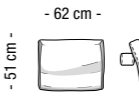

Schienale L Backrest L

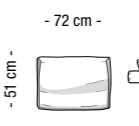

Schienale XL Backrest XL

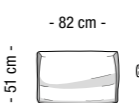

Schienale di supporto in metallo e pelle Leather and steel backrest

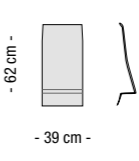

Tavolino da 48 cm in metallo e pelle Leather and steel 48 cm coffee table

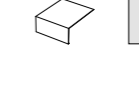
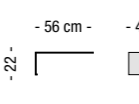

Tavolino da 68 cm in metallo e pelle Leather and steel 68 cm coffee table

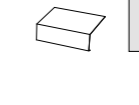
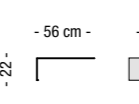

Cuscino 45x45 Cushion 45x45

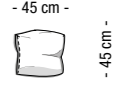

Cuscino 50x50 Cushion 50x50

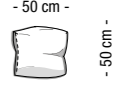

Cuscino 60x55 Back cushion 60x55

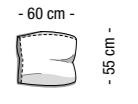

Cuscino 60x60 Back cushion 60x60

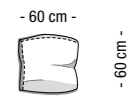

Cuscino 69x69 Back cushion 69x69

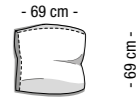

Poggiareni Lumbar rest

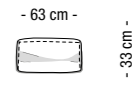

Struttura portante: in legno massello e multistrato con molleggio garantito da cinghie elastiche ad alta componente di caucciù.

Preparazione della struttura: in poliuretano espanso a quote differenziate ad alta densità e resilienza. Ulteriore rivestimento della struttura con fibra di poliestere termolegata di forte spessore, accoppiata con vellutino.

Cuscineria: imbottitura cuscino in "Memofill" canalizzato (particelle di poliuretano viscoelastico termosensibile e innovativa microfibrà "Hi-tex") con inserto centrale in poliuretano ad alta resilienza. In alternativa: sedile in poliuretano espanso speciale "Polilatex", con rivestimento in ovatta di poliestere siliconata ad alto spessore, accoppiata con tela di cotone bianca. In alternativa ulteriore: cuscino in piuma canalizzata con inserto centrale in poliuretano ad alta resilienza.

Cuscini schienale: totalmente imbottiti in piuma d'oca canalizzata certificata "Assopiuma etichetta oro" con poggiatesta integrato in fiocchi di fibra di poliestere, rivestimento supplementare in ovatta di poliestere ad alto spessore accoppiata con tela di cotone bianca per nascondere i segni della piuma.

Sfoderabilità: rivestimento sfoderabile nella versione in tessuto, fisso nella versione in pelle. Cuscini di seduta e schienale sempre sfoderabili.

Basamenti: piedi arretrati in legno massello. Basamento opzionale in metallo pressofuso ed estruso, disponibile nelle versioni: cromo, satinato, antracite o colori speciali (versione SQUARE LINE STEEL).

Poggiatesta: supporto in poliuretano espanso ad alta densità rivestito con fibra di poliestere termolegata di forte spessore, accoppiata con vellutino.

In alternativa: schienalino indipendente e spostabile in acciaio rivestito in pelle o in cuoio ecologico.

Tavolini opzionali: indipendenti e spostabili in acciaio rivestito in pelle o in cuoio ecologico, con scivolanti in nylon.

Structure: in solid wood and plywood with high natural rubber content elastic strap webbing.

Preparation of the seat: in high resilience variable-density polyurethane foam. Outer covering with heat-bonded polyester fiber laminated to technical fiber.

Seat Cushions: "Memofill" quilt (heat-sensitive foam and innovative microfiber "Hi-tex" mixed) with high resilience polyurethane foam central insert. Alternative option: "Polilatex" cushion, a special polyurethane high resilience foam covered with a high depth polyester fiber heat-bonded to white cotton canvas. Alternative option: quilted goose down padding cushion with "Polilatex" foam central insert.

Backrest cushion: channeled goose down, (Certified Assopiuma, gold label) complete with a polyester fiber lumbar support insert. Additional cover in polyester fiber and white cotton canvas in order to hide feather signs.

Covers: completely removable in fabric version and fixed in leather version. Seat cushion and backrest cushion covers are completely removable.

Base: half-hidden solid wood feet. Optional perimeter frame in extruded and die-cast metal available chrome, satin, painted anthracite or special edition colors (SQUARE LINE STEEL version).

Headrest: support in high density polyurethane, covered with heat-bonded polyester fiber laminated to technical fiber.

Alternative option: movable metal backrest covered with leather or ecologic leather.

Optional coffee tables: in steel covered with leather or ecologic leather, nylon protective glides.

SQUARE LINE VENTI

SQUARE LINE con larghezza bracciolo/schienale da 20 cm 20 cm armrest/backrest SQUARE LINE version

Disponibile in due profondità: 99 cm o 106 cm
2 depths available: 99 cm or 106 cm

Disponibile in due altezze di seduta: 42 o 45 cm
2 sitting heights available: 42 or 45 cm

Disponibile con tre tipi di materiali di seduta:
"Memofill" (soffice), "Piuma" (soffice e mossà), "Polilatex" (rigida)
3 seat cushion material versions available:
"Memofill" (soft), "Feather" (soft and wavy), "Polilatex" (hard)

Profondità seduta con schienale (M / L / XL)
Sitting depth with backrest cushion (M / L / XL)

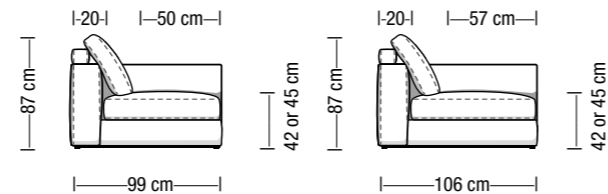

Profondità seduta indicative con cuscino da 60x60cm o 69x69cm e schienalino di supporto in metallo e pelle
Sitting depth with 60x60cm or 69x69cm backrest cushion and leather/steel headrest

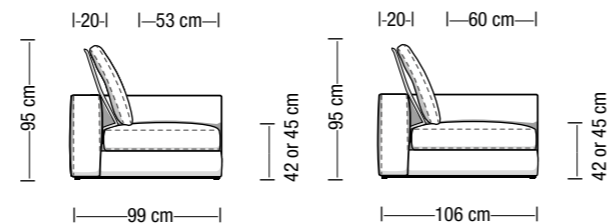

Divano da 210 cm Sofa 210 cm

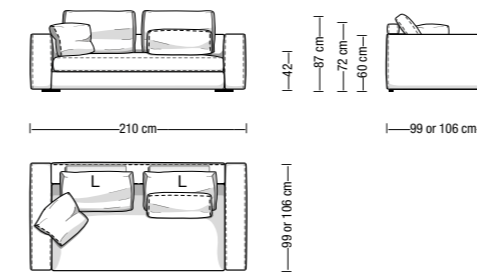

Divano da 246 cm Sofa 246 cm

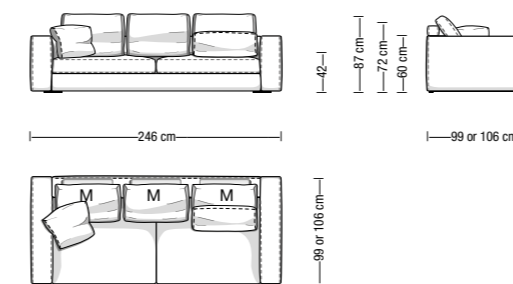

Disposizione alternativa schienali
Alternative backrest cushions layout

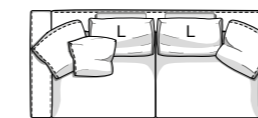

Versione divano a seduta unica
Cuscino di seduta disponibile solo in versione Polilatex
Disposizione alternativa schienali con cuscini morbidi

One-piece seat cushion version
Available only in Polilatex seat cushion version
Alternative backrest cushions layout

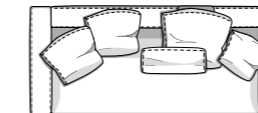

Divano da 284 cm Sofa 284 cm

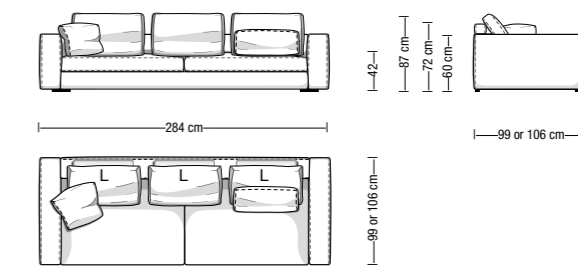

Disposizione alternativa schienali
Alternative backrest cushions layout

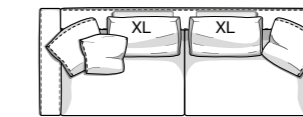

Disposizione alternativa schienali con cuscini morbidi
Alternative backrest cushions layout

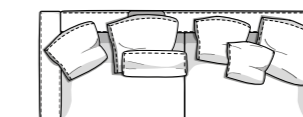

Versione divano a 3 sedute
Three seat cushions version

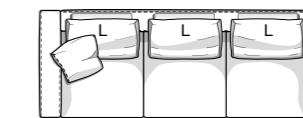

Sono disponibili misure speciali su richiesta.
I disegni a catalogo sono da considerarsi suggerimenti di configurazione:
schienali e cuscini sono elementi liberamente abbinabili.

Custom-made elements are available on request.
Drawings are configuration suggestions:
backrests and cushions are freely combinable elements.



Divano a 1 bracciolo da 155 cm
Element with 1 armrest 155 cm

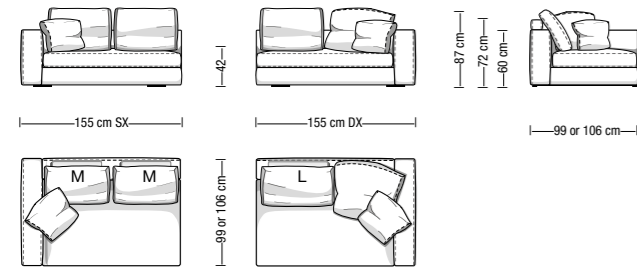

Divano a 1 bracciolo da 226 cm
Element with 1 armrest 226 cm

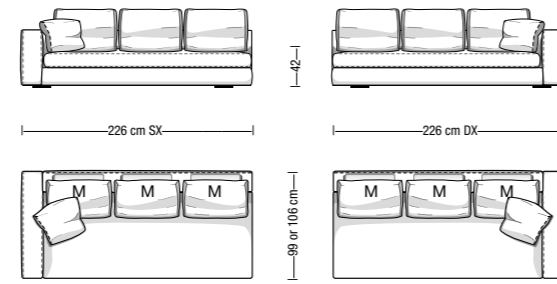

Versione divano a seduta unica, disponibile solo in versione Polliatex
One-piece seat cushion version, available only in Polliatex seat cushion

Versione divano a 2 sedute
Two seat cushions version

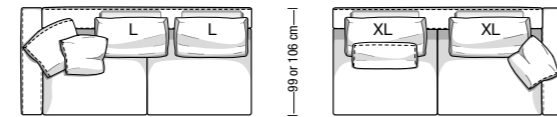

Divano a 1 bracciolo da 264 cm
Element with 1 armrest 264 cm

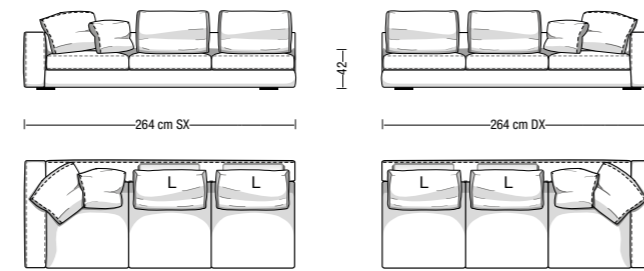

Versione divano a 2 sedute
Two seat cushions version

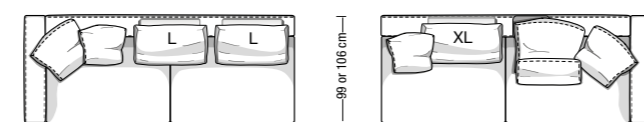

Divano a 1 bracciolo da 175 cm
Element with 1 armrest 175 cm

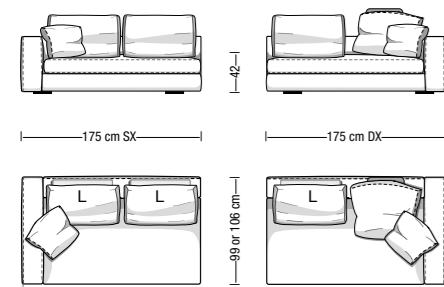

Divano a 1 bracciolo da 190 cm
Element with 1 armrest 190 cm

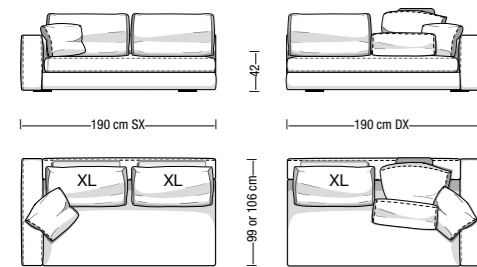

Angolare/Chaise longue da 155 cm
Corner element/Chaise longue 155 cm

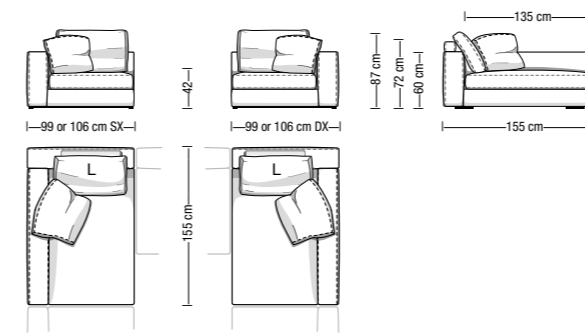

Angolare/Chaise longue da 175 cm
Corner element/Chaise longue 175 cm

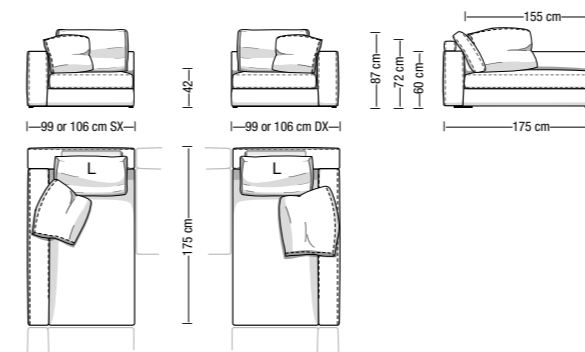

Angolare/Chaise longue da 190 cm
Corner element/Chaise longue 190 cm

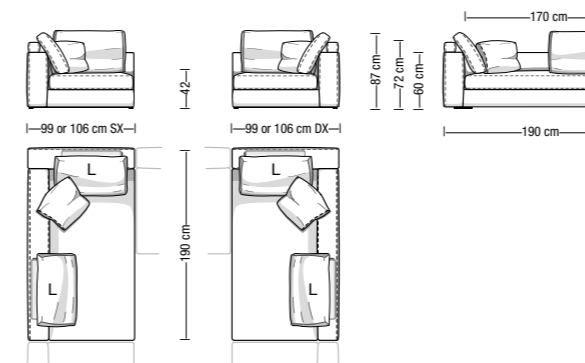

Terminale con penisola da 210 cm
Open-end terminal element 210 cm

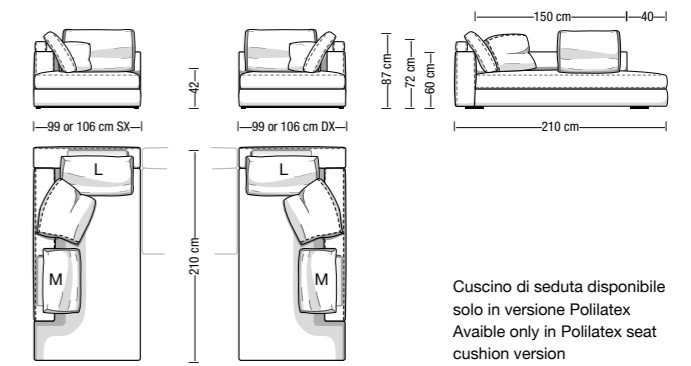

Cuscino di seduta disponibile solo in versione Polliatex
Available only in Polliatex seat cushion version

Terminale/Angolare da 226 cm
Terminal/Corner element 226 cm

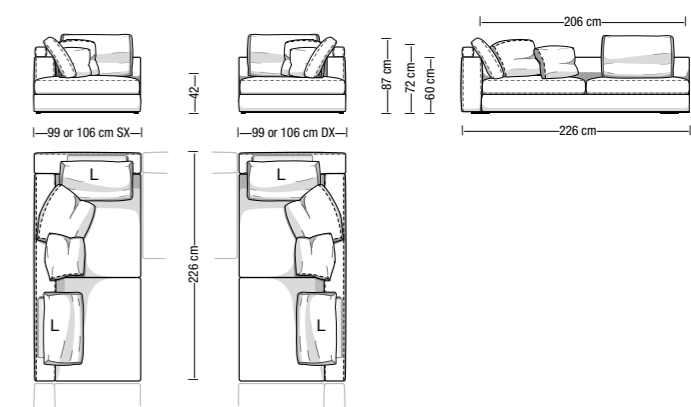

Terminale/Angolare da 264 cm
Terminal/Corner element 264 cm

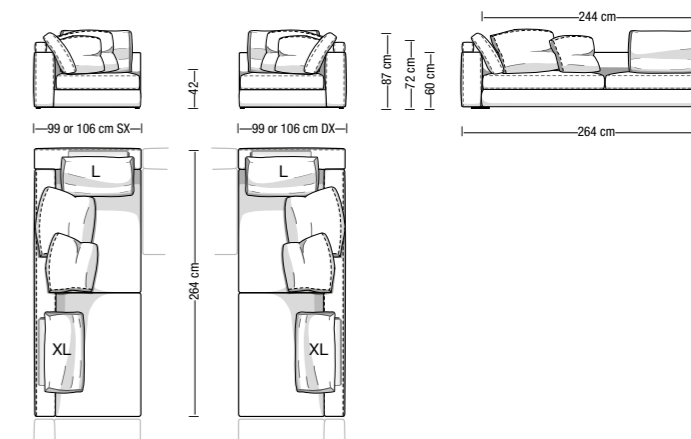

Poltrona terminale con penisola da 125 cm
Open-end armchair 125 cm

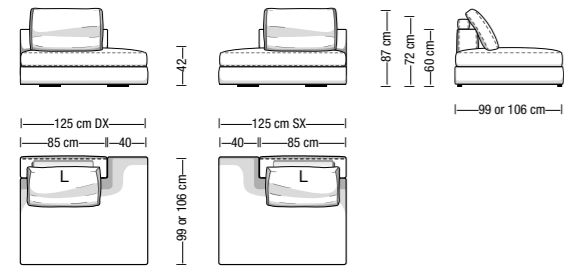

Divano terminale con penisola senza bracciolo da 190 cm
Open-end terminal element without armrest 190 cm

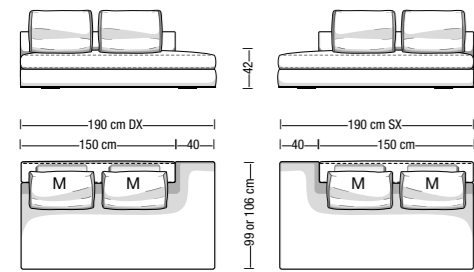

Cuscino di seduta disponibile solo in versione Pollatex
Available only in Pollatex seat cushion version

Divano a 1 bracciolo con penisola da 210 cm
Open-end element with 1 armrest 210 cm

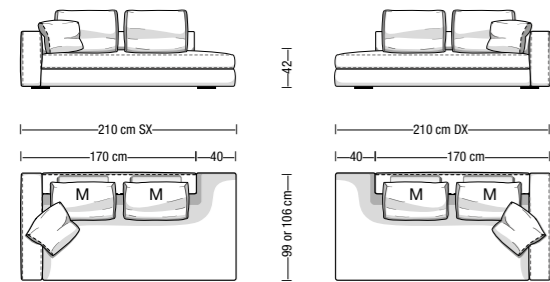

Cuscino di seduta disponibile solo in versione Pollatex
Available only in Pollatex seat cushion version

Chaise longue da 123x170 cm
Chaise longue 123x170 cm

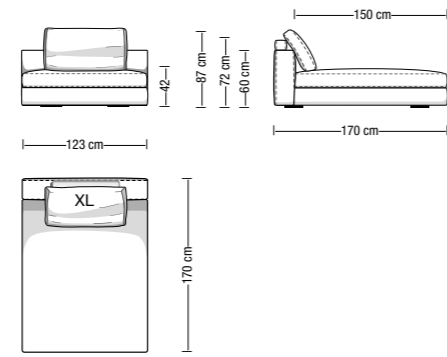

Disposizione alternativa schienali con cuscini morbidi
Alternative backrest cushions layout

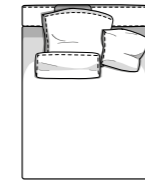

Chaise longue con 1 bracciolo da 143x170 cm
Chaise longue with 1 armrest 143x170 cm

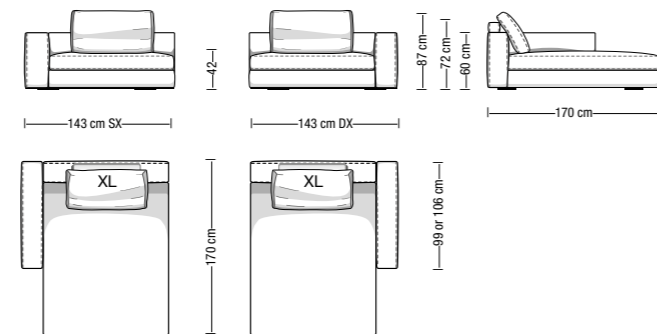

Disposizione alternativa schienali con cuscini morbidi
Alternative backrest cushions layout

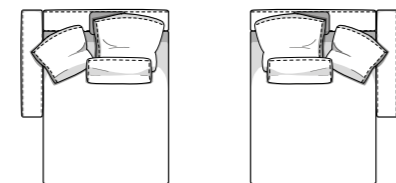

Poltrona/Elemento centrale da 104 cm
Armchair/Central element 104 cm

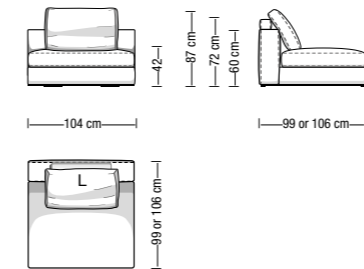

Poltrona/Elemento centrale da 123 cm
Armchair/Central element 123 cm

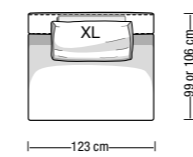

Elemento centrale da 135 cm
Central element 135 cm

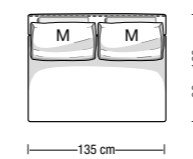

Elemento centrale da 155 cm
Central element 155 cm

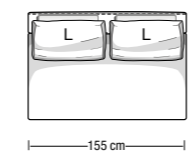

Elemento centrale da 170 cm
Central element 170 cm

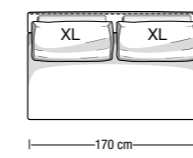

Pouf da 104x78 cm o 104x85 cm
Ottoman 104x78 cm or 104x85 cm

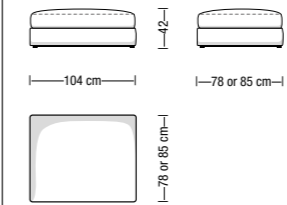

Pouf da 123x78 cm o 123x85 cm
Ottoman 123x78 cm or 123x85 cm

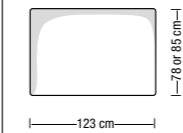

Pouf da 99x99 cm
Ottoman 99x99 cm

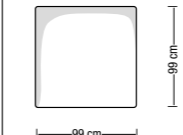

Pouf da 106x106 cm
Ottoman 106x106 cm

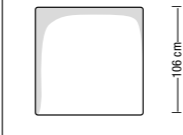

Schienale M
Backrest M

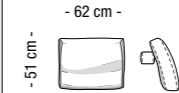

Schienale L
Backrest L

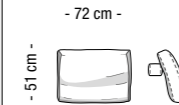

Schienale XL
Backrest XL

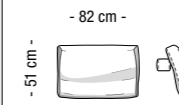

Schienale di supporto in metallo e pelle
Leather and steel backrest

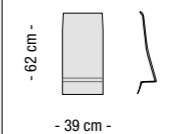

Tavolino da 48 cm in metallo e pelle
Leather and steel 48 cm coffee table

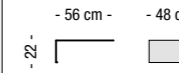

Tavolino da 68 cm in metallo e pelle
Leather and steel 68 cm coffee table

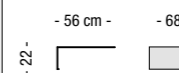

Cuscino 45x45
Cushion 45x45

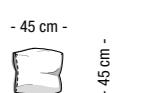

Cuscino 50x50
Cushion 50x50

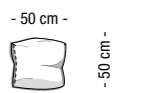

Cuscino 60x55
Back cushion 60x55

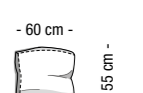

Cuscino 60x60
Back cushion 60x60

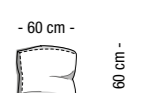

Cuscino 69x69
Back cushion 69x69



Poggiareni
Lumbar rest

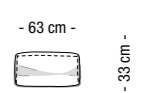

Struttura portante: in legno massello e multistrato monoscocca con molleggio garantito da cinghie elastiche ad alta componente di caucciù.

Preparazione della struttura: in poliuretano espanso a quote differenziate ad alta densità e resilienza. Ulteriore rivestimento della struttura con fibra di poliestere termolegata di forte spessore, accoppiata con vellutino.

Cuscinatura: imbottitura cuscino di seduta in poliuretano espanso speciale a densità differenziate con MEMOSOFF e rivestimento in ovatta di poliestere siliconata ad alto spessore, accoppiata con tela di cotone bianca.

Cuscini schienale: in piuma d'oca canalizzata certificata "Assopiuma etichetta Oro" con inserto in poliuretano espanso.

Cuscini ornamentali: in piuma d'oca canalizzata certificata "Assopiuma".

Sfoderabilità: rivestimento sfoderabile nella versione in tessuto, fisso nella versione in pelle. Cuscini seduta e schienale sempre sfoderabili.

Basamenti: piedi a disegno speciale in metallo pressofuso, finitura Pewter.

Poggiatesta opzionali: schienalini indipendenti e spostabili in acciaio rivestito in pelle o in cuoio ecologico.

Structure: in solid wood and plywood, monocoque, with high natural rubber content elastic strap webbing.

Preparation of the seat: in high resilience variable-density polyurethane foam. Outer covering with heat-bonded polyester fiber laminated to technical fiber.

Seat cushion: in high resilience variable-density polyurethane foam (with MEMOSOFF, special Polyurethane), covered with a high depth polyester silicon fiber heat-bonded to white cotton canvas.

Backrest cushion: channeled goose down, (Certified Assopiuma, gold label) with a special polyurethane foam central insert. Ornamental cushion: channeled goose down, certified "Assopiuma".

Covers: are completely removable in fabric version and fixed in leather version. Seat cushion and backrest cushion covers are completely removable.

Base: special design die-cast metal feet, painted Pewter.

Optional headrest: movable metal backrest covered with leather or ecologic leather.

BLUM

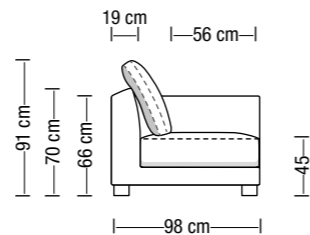

Divano da 190 cm
Sofa 190 cm

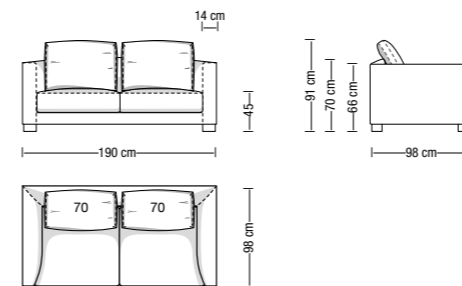

Divano da 215 cm
Sofa 215 cm

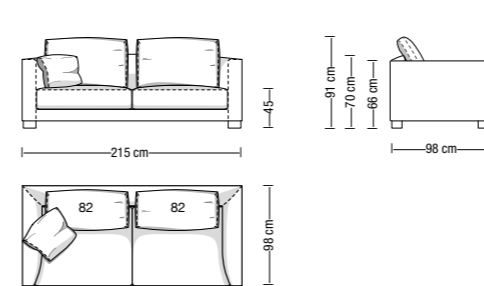

Divano da 240 cm
Sofa 240 cm

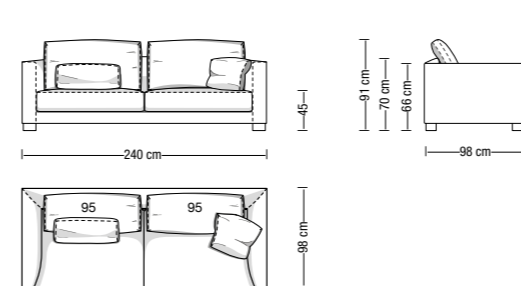

Disposizione alternativa schienali
Alternative backrest cushions setup

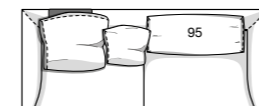

Divano da 265 cm
Sofa 265 cm

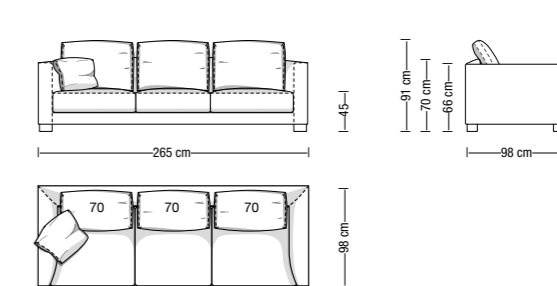

Versione divano a 2 sedute
Two seat cushions version

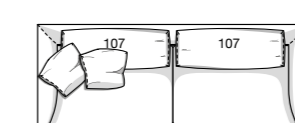

Disposizione alternativa schienali
Alternative backrest cushions setup

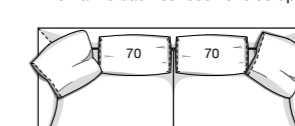

Disposizione alternativa schienali
Alternative backrest cushions setup



Sono disponibili misure speciali su richiesta.
I disegni a catalogo sono da considerarsi suggerimenti di configurazione:
schienali e cuscini sono elementi liberamente abbinabili.

Custom-made elements are available on request.
Drawings are configuration suggestions:
backrests and cushions are freely combinable elements.

Divano a 1 bracciolo da 171 cm
Element with 1 armrest 171 cm

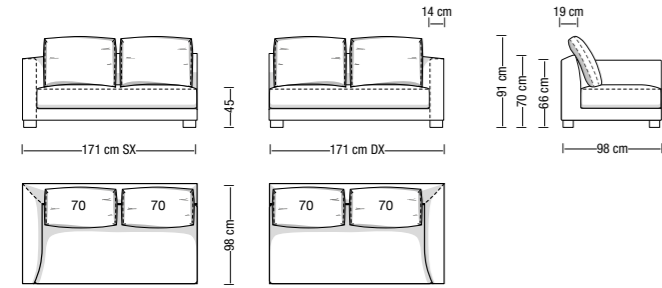

Versione divano a 2 sedute
Two seat cushions version

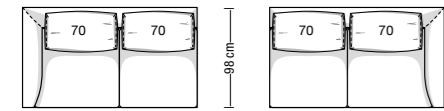

Divano a 1 bracciolo da 196 cm
Element with 1 armrest 196 cm

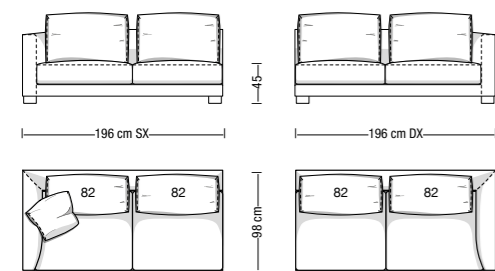

Divano a 1 bracciolo da 221 cm
Element with 1 armrest 221 cm

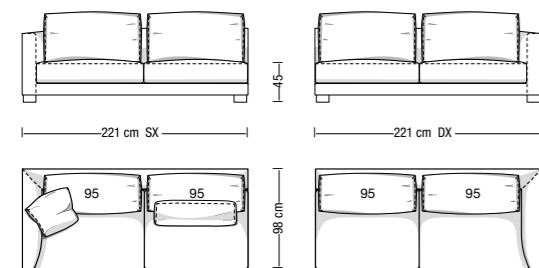

Divano a 1 bracciolo da 246 cm
Element with 1 armrest 246 cm

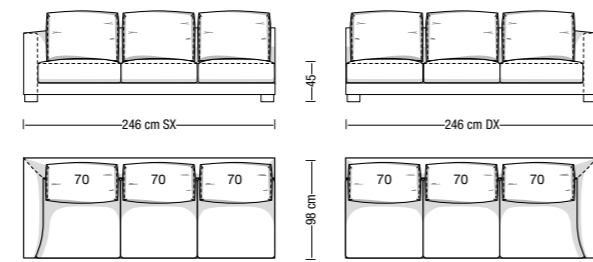

Versione divano a 2 sedute
Two seat cushions version

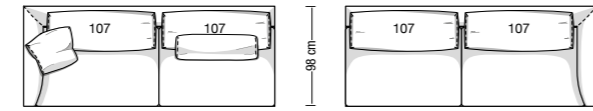

Disposizione alternativa schienali
Alternative backrest cushions setup

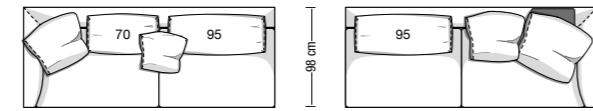

Angolare terminale da 215 cm
Terminal corner element 215 cm

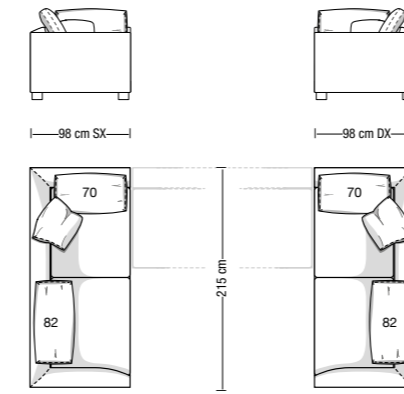

Angolare terminale da 240 cm
Terminal corner element 240 cm

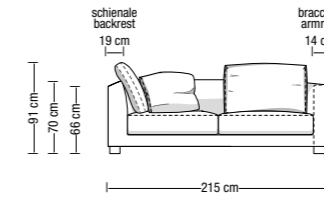
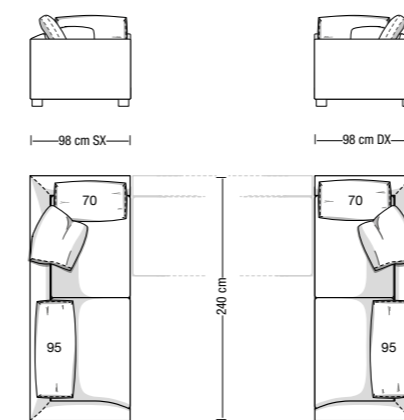

Angolare terminale da 265 cm
Terminal corner element 265 cm

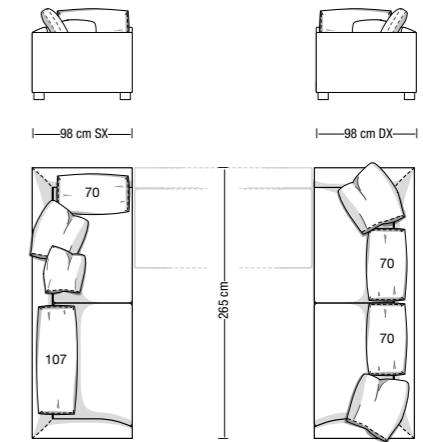

Disposizione alternativa schienali
Alternative backrest cushions setup

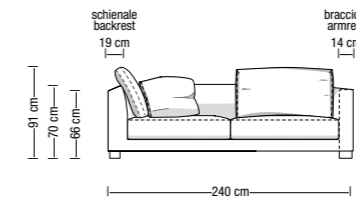

Angolare da 120 cm
Corner element 120 cm

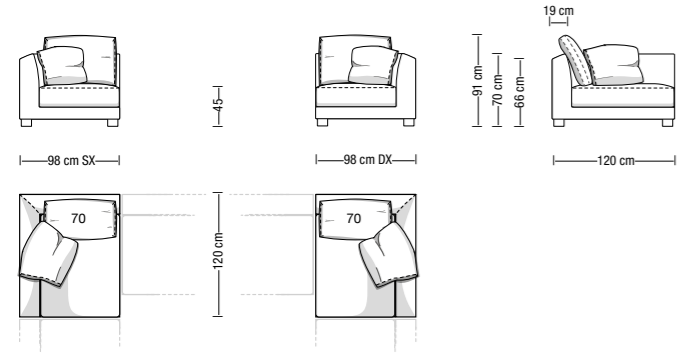

Angolare da 221 cm
Corner element 221 cm

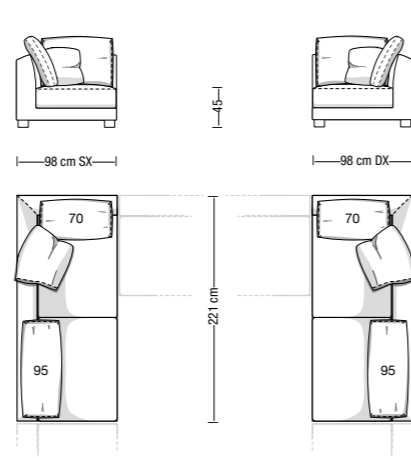

Angolare da 139 cm
Corner element 139 cm

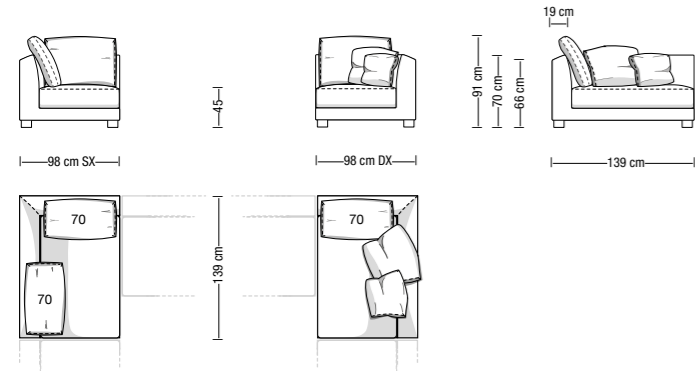

Angolare da 246 cm
Corner element 246 cm

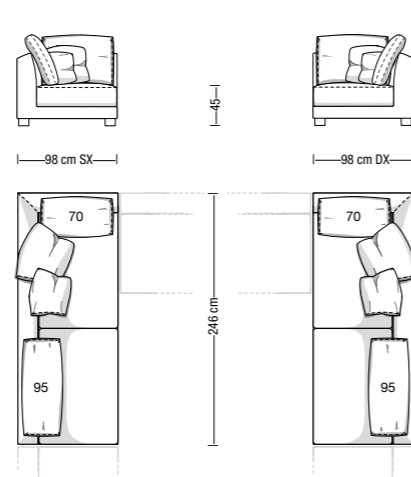

Angolare da 171 cm
Corner element 171 cm

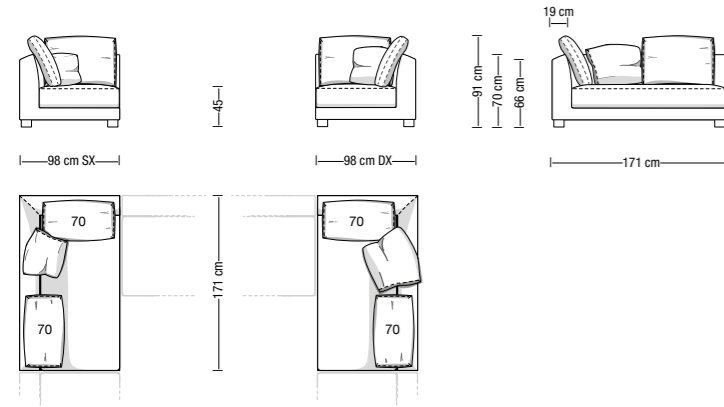

Chaise longue con 1 bracciolo da 109x160 cm
Chaise longue with 1 armrest 109x160 cm

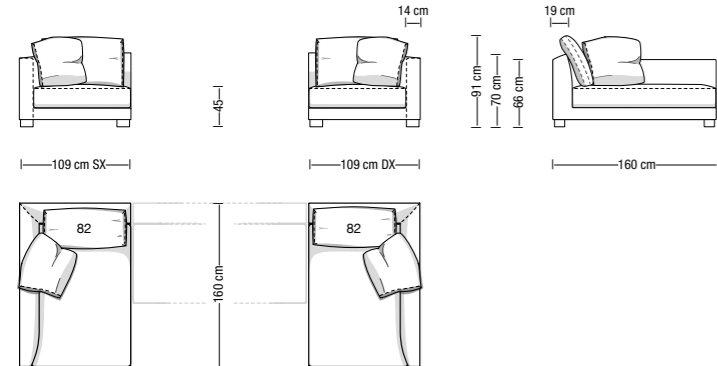

Chaise longue con 1 bracciolo da 134x160 cm
Chaise longue with 1 armrest 134x160 cm

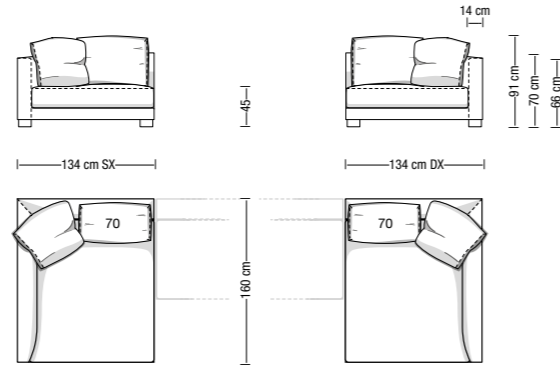

Pouff da 82 cm
Ottoman 82 cm

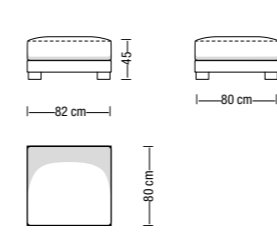

Pouff da 120 cm
Ottoman 120 cm

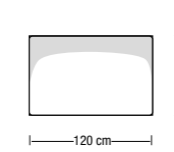

Pouff da 95 cm
Ottoman 95 cm

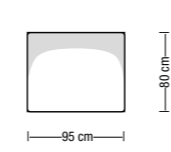

Pouff da 98x60 cm
Ottoman 98x60 cm

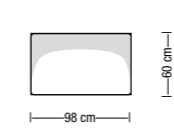

Pouff da 108 cm
Ottoman 108 cm

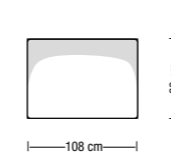

Pouff da 98x98 cm
Ottoman 98x98 cm

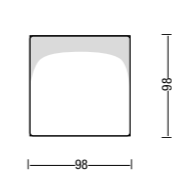

Schienale 70
Backrest 70

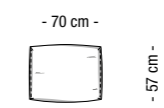

Cuscino 45x45
Cushion 45x45

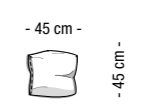

Schienale 82
Backrest 82

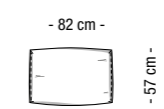

Cuscino 60x60
Back cushion 60x60



Schienale 95
Backrest 95

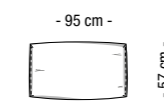

Cuscino 69x69
Back cushion 69x69



Schienale 107
Backrest 107

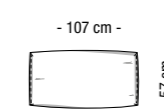

Poggiareni 63
Lumbar rest 63

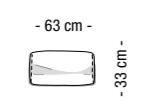

Schienale di supporto
in metallo e pelle
Leather and steel backrest

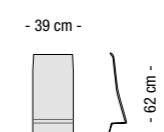

Poggiareni 83
Lumbar rest 83

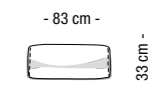

Struttura portante: in legno massello e multistrato con molleggio garantito da cinghie elastiche ad alta componente di caucciù.

Preparazione della struttura: in poliuretano espanso a quote differenziate ad alta densità e resilienza. Ulteriore rivestimento della struttura con fibra di poliestere termolegata di forte spessore, accoppiata con vellutino.

Cuscinatura: imbottitura cuscino sedile in poliuretano espanso speciale "Polilatex", con rivestimento in ovatta di poliestere siliconata ad alto spessore, accoppiata con tela di cotone bianca.

Cuscini schienale: totalmente imbottiti in piuma d'oca canalizzata certificata "Assopiuma etichetta Oro" con poggiatesta in fiocchi di fibra di poliestere integrato. Cuscini ornamentali in piuma d'oca canalizzata certificata "Assopiuma".

Sfoderabilità: rivestimento sfoderabile nella versione in tessuto, fisso nella versione in pelle. Cuscini seduta e schienale sempre sfoderabili.

Basamenti: piedi a disegno speciale in metallo pressofuso, disponibile nelle versioni: cromo, satinato o Peltro.

Poggiatesta: supporto in poliuretano espanso ad alta densità rivestito con fibra di poliestere termolegata di forte spessore, accoppiata con vellutino.

Structure: in solid wood and plywood, with high natural rubber content elastic strap webbing.

Preparation of the seat: in high resilience variable-density polyurethane foam. Outer covering with heat-bonded polyester fiber laminated to technical fiber.

Seat Cushions: in high resilience special polyurethane foam "Polilatex" covered with a high depth polyester silicon fiber heat-bonded to white cotton canvas.

Backrest cushion: channeled goose down, certified "Assopiuma", gold label, complete with a lumbar support polyester fiber insert. Ornamental cushion channeled goose down, certified "Assopiuma"

Covers: completely removable in fabric version and fixed in leather version. Seat cushion and backrest cushion covers are completely removable.

Base: special design die-cast metal feet chrome, satin, painted Pewter.

Headrest: support in high density polyurethane, covered with heat-bonded polyester fiber laminated to technical fiber.

WILL

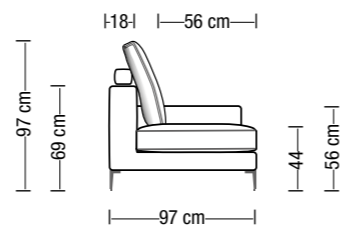
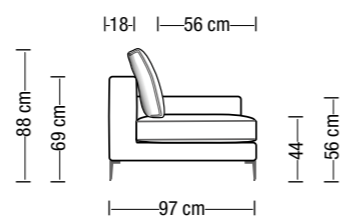

Divano da 195 cm
Sofa 195 cm

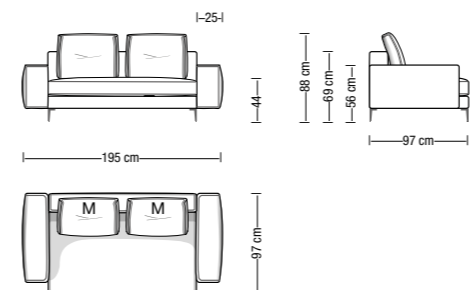

Divano da 220 cm
Sofa 220 cm

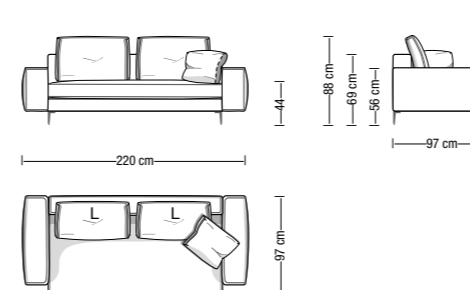

Divano da 245 cm
Sofa 245 cm

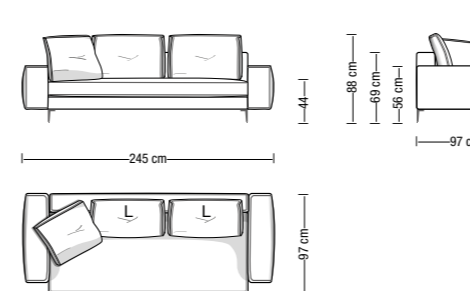

Divano da 265 cm
Sofa 265 cm

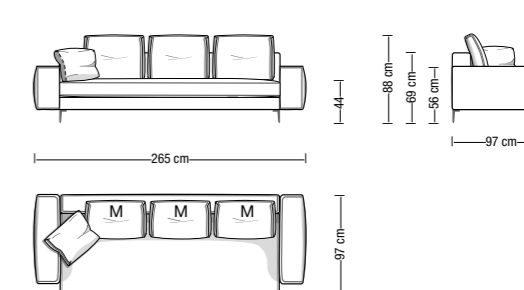

Disposizione alternativa schienali
Alternative backrest cushions setup

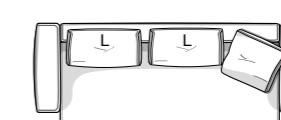

Divano da 290 cm
Sofa 290 cm

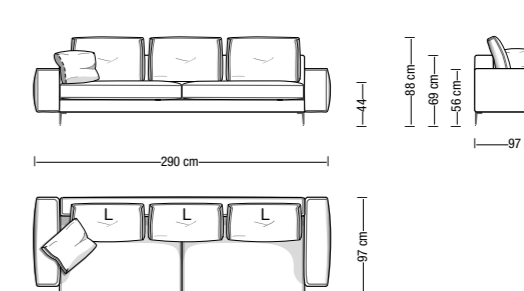

Disposizione alternativa schienali
Alternative backrest cushions setup

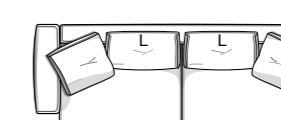

Finiture basamento
Metal base finish



Peltro
Pewter



Alluminio spazzolato
Brushed aluminium



Sono disponibili misure speciali su richiesta.
I disegni a catalogo sono da considerarsi suggerimenti di configurazione:
schienali e cuscini sono elementi liberamente abbinabili.

Custom-made elements are available on request.
Drawings are configuration suggestions:
backrests and cushions are freely combinable elements.

Divano a 1 bracciolo da 170 cm
Element with 1 armrest 170 cm

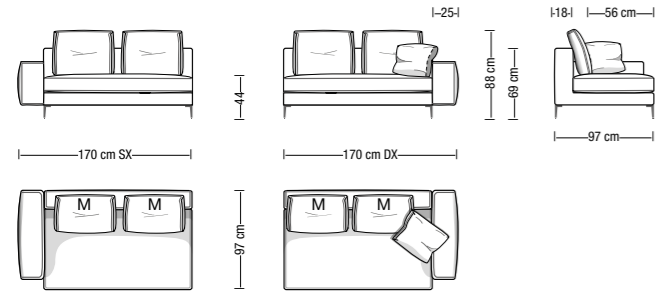

Divano a 1 bracciolo da 240 cm
Element with 1 armrest 240 cm

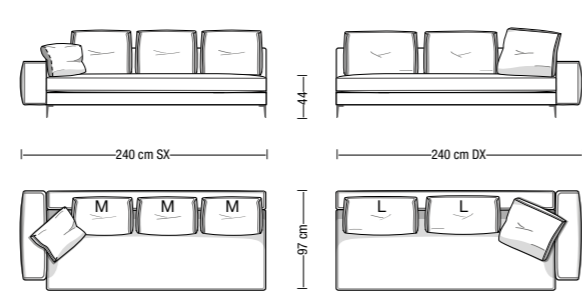

Disposizione alternativa schienali
Alternative backrest cushions setup

Divano a 1 bracciolo da 195 cm
Element with 1 armrest 195 cm

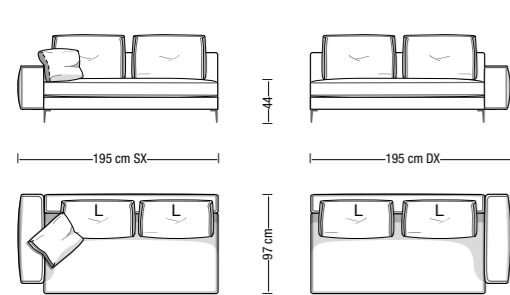

Divano a 1 bracciolo da 265 cm
Element with 1 armrest 265 cm

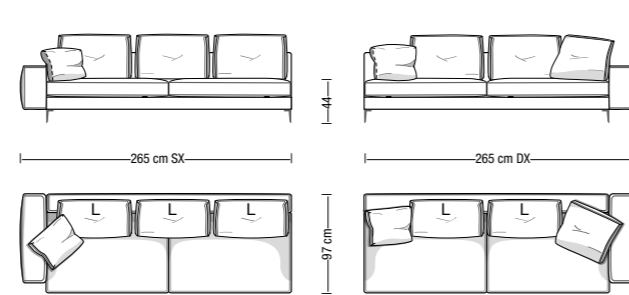

Disposizione alternativa schienali
Alternative backrest cushions setup

Divano a 1 bracciolo da 220 cm
Element with 1 armrest 220 cm

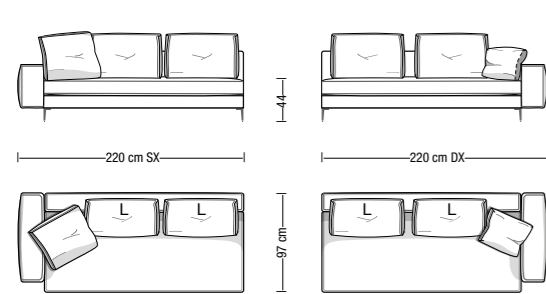

Elemento centrale da 170 cm
Central element 170 cm

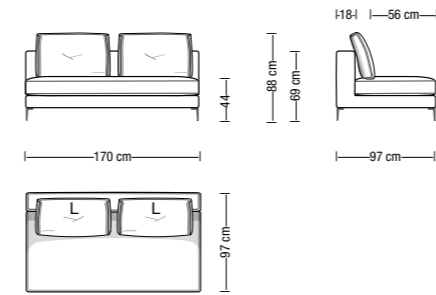

Elemento centrale da 215 cm
Central element 215 cm

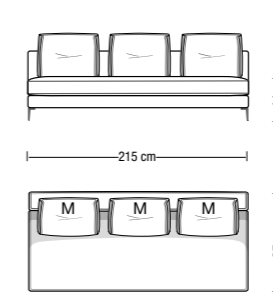

Elemento centrale da 195 cm
Central element 195 cm

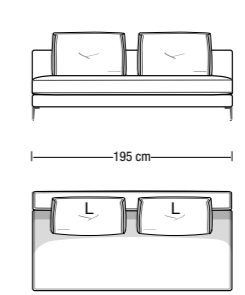

Elemento centrale da 240 cm
Central element 240 cm

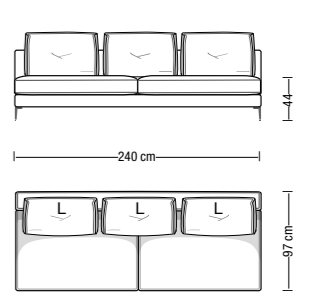

Gli elemento centrali possono essere utilizzati anche come divani senza braccioli
The central elements are also usable as sofas without armrests

Terminale con penisola da 200x97 cm
Open-end terminal element 200x97 cm

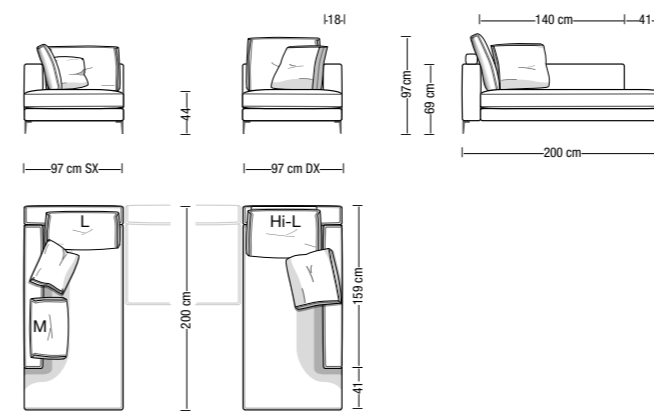

Terminale con penisola da 234x97 cm
Open-end terminal element 234x97 cm



Terminale con penisola da 200x107 cm
Open-end terminal element 200x107 cm

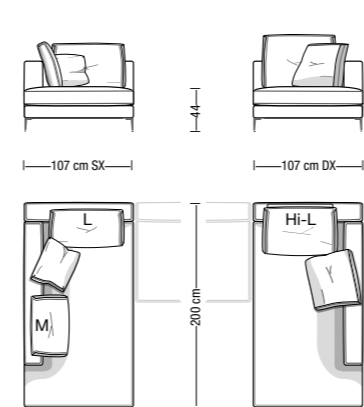

Disposizione alternativa
schienali
Alternative backrest
cushions setup

Terminale con penisola da 234x107 cm
Open-end terminal element 234x107 cm

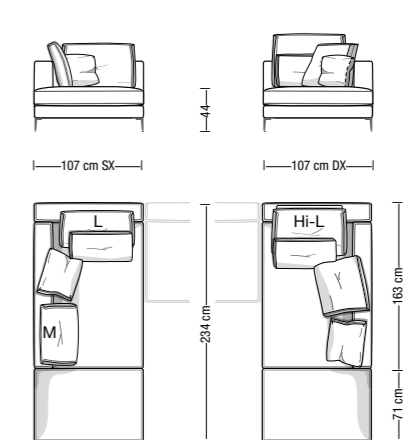

Angolare/Chaise longue da 163 cm
Corner element/Chaise longue 163 cm

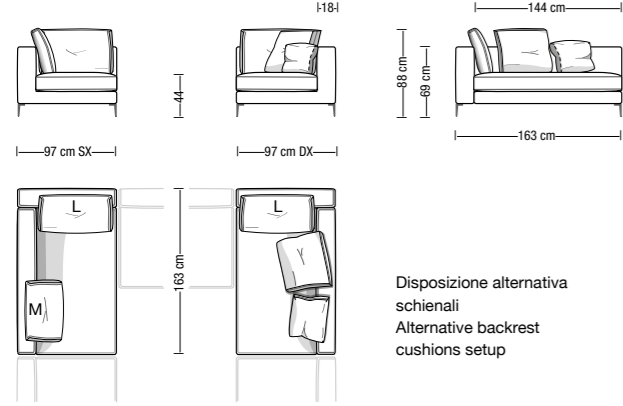

Disposizione alternativa
 schienali
 Alternative backrest
 cushions setup

Terminale/Angolare da 213 cm
Terminal/Corner element 213 cm

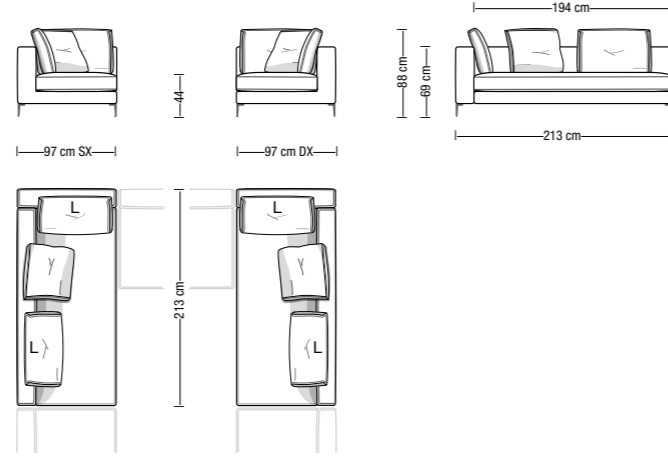

Angolare/Chaise longue da 188 cm
Corner element/Chaise longue 188 cm

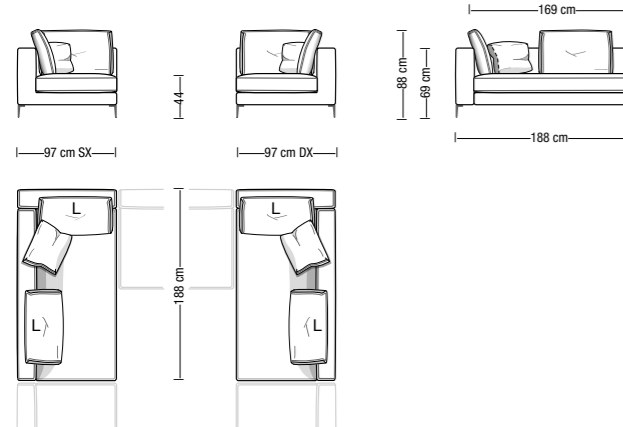

Terminale/Angolare da 233 cm
Terminal/Corner element 233 cm

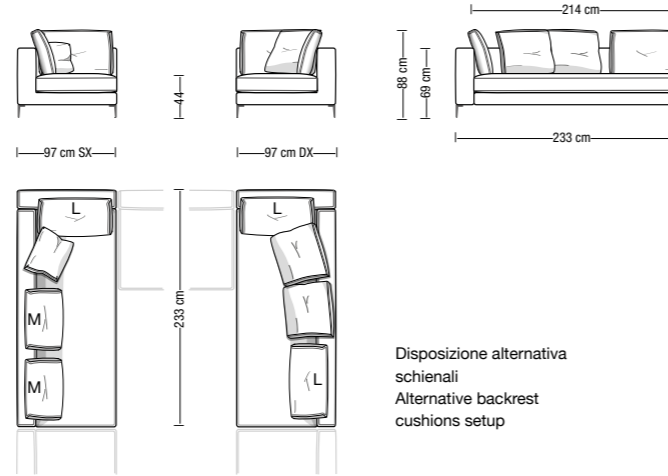

Disposizione alternativa
 schienali
 Alternative backrest
 cushions setup

Terminale/Angolare da 258 cm
Terminal/Corner element 258 cm

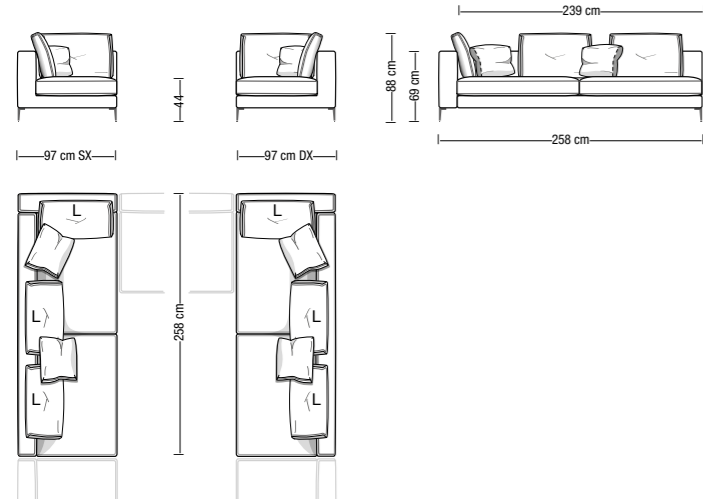

Pouff da 79x79 cm
Ottoman 79x79 cm

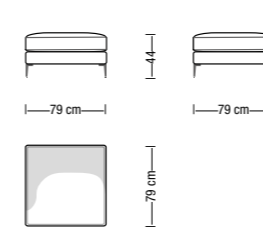

Pouff da 121x79 cm
Ottoman 121x79 cm

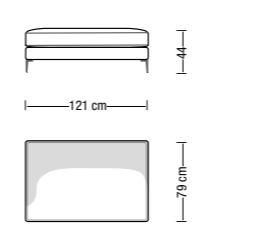

Pouff da 145x79 cm
Ottoman 145x79 cm

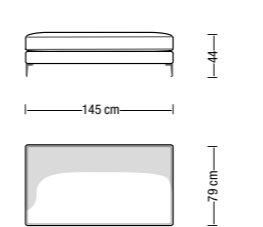

Pouff da 145x89 cm
Ottoman 145x89 cm

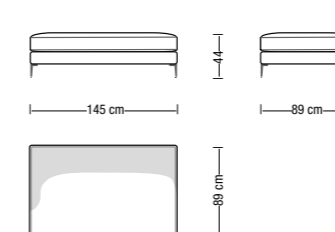

Pouff da 97x71 cm
Ottoman 97x71 cm

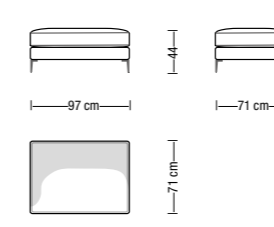

Pouff da 107x71 cm
Ottoman 107x71 cm

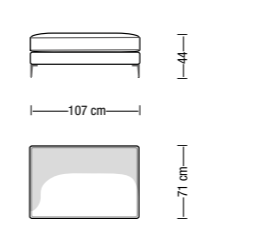

Schienale M
Backrest M



Schienale L
Backrest L

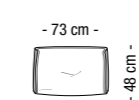

Schienale L Alto
con rullo indipendente
Backrest L
with independent headrest roll

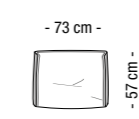

Cuscino 45x45
Cushion 45x45



Cuscino 60x60
Back cushion 60x60



Poggiareni
Lumbar rest



Struttura portante: in legno massello e multistrato con molleggio garantito da cinghie elastiche ad alta componente di caucciù.

Preparazione della struttura: in poliuretano espanso a quote differenziate ad alta densità e resilienza. Ulteriore rivestimento della struttura con fibra di poliestere termolegata di forte spessore, accoppiata con vellutino.

Cuscinatura: cuscino in piuma canalizzata con inserto con inserto centrale in poliuretano ad alta resilienza.

Cuscini schienali: in piuma canalizzata certificati "Assopiuma". In alternativa: in speciale miscela di piuma e fiocchi di fibra canalizzata.

Sfoderabilità: rivestimento sfoderabile nella versione in tessuto e in pelle. Cuscini seduta e schienale sono sempre sfoderabili.

Basamenti: piedi arretrati in legno massello.

Poggiatesta opzionale: schienalino indipendente e spostabile in acciaio rivestito in pelle o in cuoio ecologico.

Structure: in solid wood and plywood, with high natural rubber content elastic strap webbing.

Preparation of the seat: in high resilience variable-density polyurethane foam. Outer covering with heat-bonded polyester fiber laminated to white technical fiber.

Seat Cushions: quilted goose down padding cushion with high resilience polyurethane foam central insert.

Backrest cushion: channeled goose down, certified "Assopiuma". Alternative option: channeled feather and polyester fiber padding mixed.

Covers: are completely removable in fabric and in leather version. Seat cushion and backrest cushion covers are completely removable.

Base: half-hidden solid wood feet painted.

Optional headrest: movable metal backrest covered with leather or ecologic leather.

SHABBY

Disponibile in due profondità: 104 cm o 111 cm
2 depths available: 104 cm or 111 cm

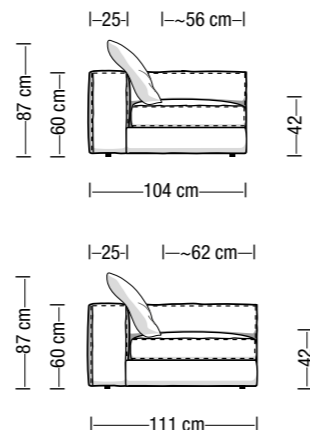

Divano da 220 cm
Sofa 220 cm

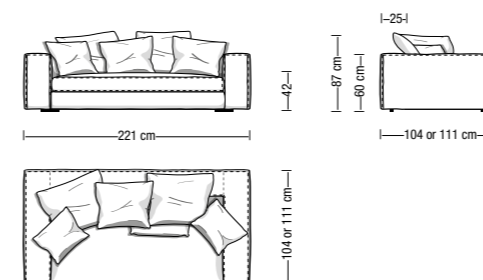

Divano da 256 cm
Sofa 256 cm

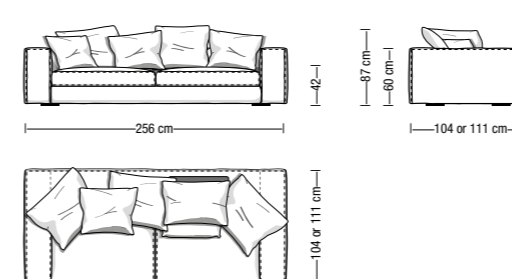

Divano da 294 cm
Sofa 294 cm

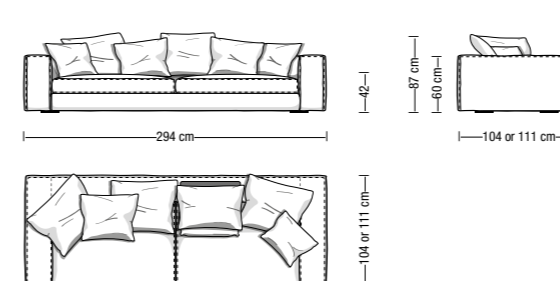

Pouff da 104x78 cm o 104x85 cm
Ottoman 104x78 cm or 104x85 cm

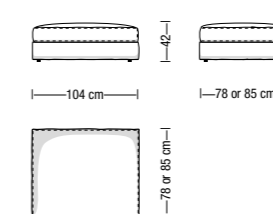

Pouff da 111x78 cm o 111x85 cm
Ottoman 111x78 cm or 111x85 cm

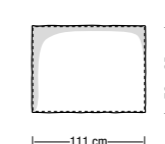

Pouff da 123x78 cm o 123x85 cm
Ottoman 123x78 cm or 123x85 cm

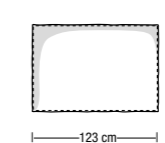

Pouff da 104x104 cm
Ottoman 104x104 cm

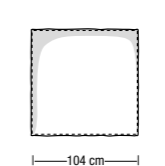

Pouff da 111x111 cm
Ottoman 111x111 cm

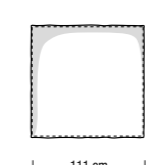

Cuscino 45x45 piuma
Cushion 45x45 feather



Cuscino 55x55 piuma
Cushion 55x55 feather



Cuscino 65x65 piuma
Back cushion 65x65 feather



Cuscino 65x55 piuma
Back cushion 65x55 feather



Poggiareni
Lumbar rest

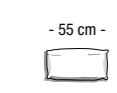

Schienalino di supporto
in metallo e pelle
Leather and steel backrest

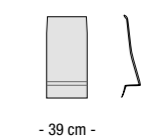

Sono disponibili misure speciali su richiesta.
I disegni a catalogo sono da considerarsi suggerimenti di configurazione:
schienali e cuscini sono elementi liberamente abbinabili.

Custom-made elements are available on request.
Drawings are configuration suggestions:
backrests and cushions are freely combinable elements.



Divano a 1 bracciolo da 160 cm
Element with 1 armrest 160 cm

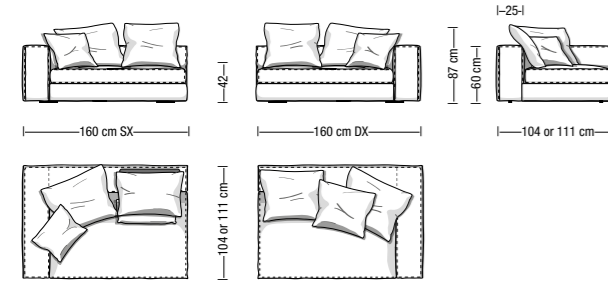

Poltrona/Elemento centrale da 104 cm
Armchair/Central element 104 cm

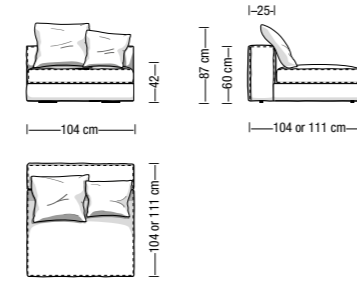

Angolare/Chaise longue da 160 cm
Corner element/Chaise longue 160 cm

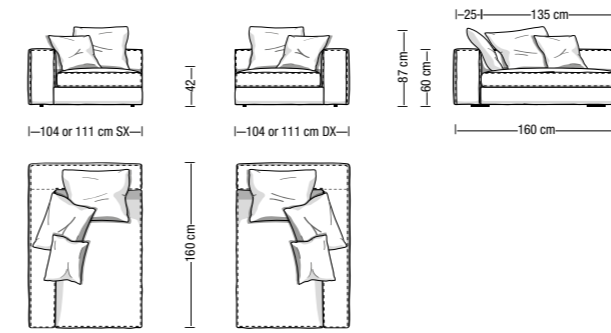

Terminale/Angolare da 231 cm
Terminal/Corner element 231 cm

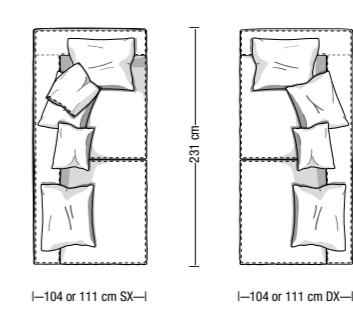

Divano a 1 bracciolo da 180 cm
Element with 1 armrest 180 cm

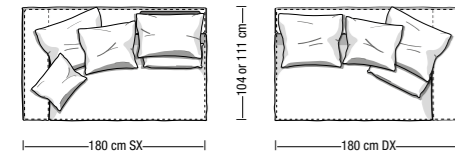

Poltrona/Elemento centrale da 123 cm
Armchair/Central element 123 cm

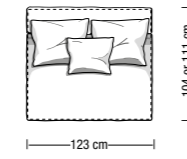

Angolare/Chaise longue da 180 cm
Corner element/Chaise longue 180 cm

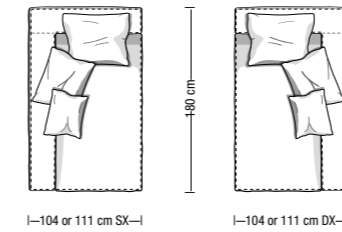

Terminale/Angolare da 269 cm
Terminal/Corner element 269 cm

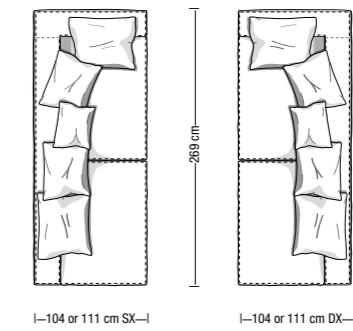

Divano a 1 bracciolo da 195 cm
Element with 1 armrest 195 cm

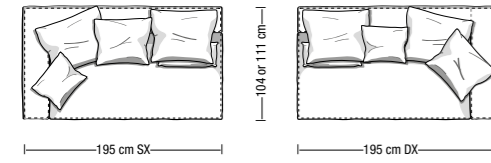

Elemento centrale da 135 cm
Central element 135 cm

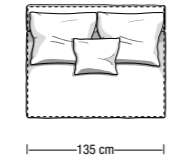

Angolare/Chaise longue da 195 cm
Corner element/Chaise longue 195 cm

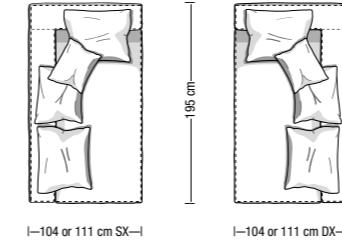

Divano a 1 bracciolo da 231 cm
Element with 1 armrest 231 cm

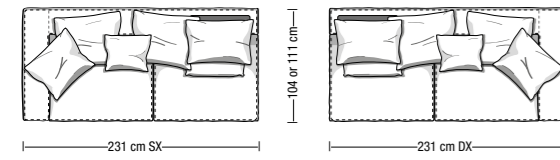

Elemento centrale da 155 cm
Central element 155 cm

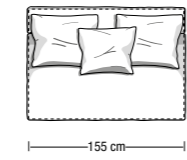

Divano a 1 bracciolo da 269 cm
Element with 1 armrest 269 cm

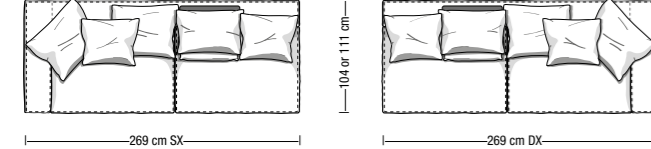

Elemento centrale da 170 cm
Central element 170 cm

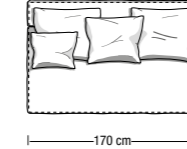

Struttura: in metallo pressofuso verniciato
Peltro, Bronzo o Oro sand.

Finiture piani: in MDF rivestiti in cuoio naturale, in MDF laccati nei colori in collezione, in marmo o vetro (solo FR130).

Structure: in die-cast metal with Pewter, Bronze or Oro sand painted finish.

Top finishes: natural hide-leather covered, lacquered as available colors, marble or glass (only FR130).

FR52
Tavolino tondo 52 cm
Round table 52 cm

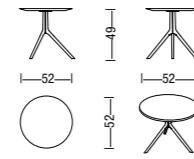

FR52LX
Tavolino tondo 52 cm con luce e ricarica USB
Round table 52 cm with light and USB charging

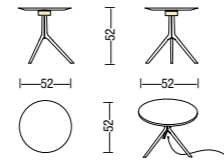

FR60
Tavolino tondo 60 cm
Round table 60 cm

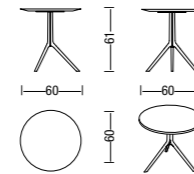

FR80
Tavolino tondo 80 cm
Round table 80 cm

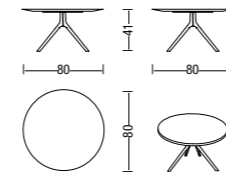

FR80A
Tavolino tondo 80 cm H73 cm
Round table 80 cm H73 cm

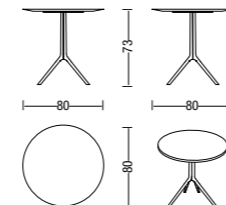

FR130
Tavolo/console 130x65 cm
Coffee table 130x65 cm

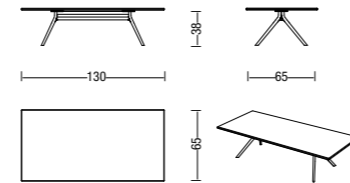

Finiture struttura in metallo
Metal structure finish



Finiture piani
Top finishes

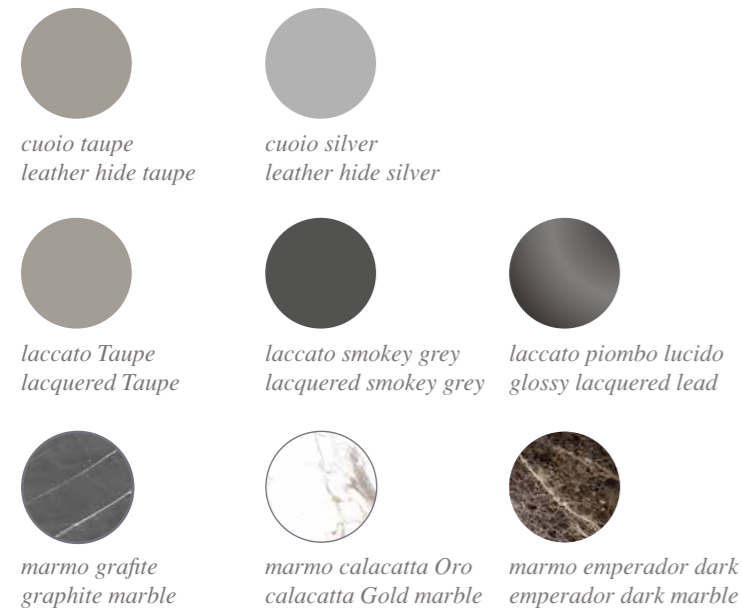

Vedi pagina 44 per le abbinare
See page 44 for combined colors



TAVOLINI

Struttura: in metallo verniciato Peltro o Bronzo.

Finiture piani: in MDF impiallacciati rovere spessart a poro aperto o in MDF laccati nei colori in collezione.

Basamento: piedi arretrati in legno massello.

TAVOLINI ROTONDI

Struttura: in metallo verniciato Peltro o Bronzo.

Finiture piani: in MDF rivestiti in cuoio naturale o in MDF laccati nei colori in collezione.

TABLES

Structure: in metal with Pewter or Bronze painted finish.

Top finishes: spessart Oak wood veneer with open pores or lacquered as available colors.

Base: half-hidden wood feet.

ROUND TABLES

Structure: in metal with Pewter or Bronze painted finish.

Top finishes: natural leather-covered or lacquered as available colors.

GLT40
Tavolino Glam 40x45 cm
Glam side table 40x45 cm

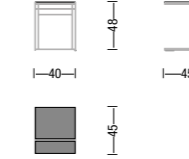

GLT99
Tavolino Glam 99x45 cm
Glam coffee table 99x45 cm

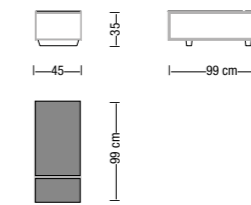

GLT47LXB
Tavolino Glam tondo 47 cm con luce, batteria integrata e ricarica USB
Glam round side-table 47 cm with light, built-in battery and USB charging

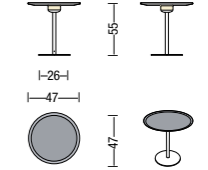

GLT52LX
Tavolino Glam tondo 52 cm con luce e ricarica USB
Glam round table 52 cm with light and USB charging

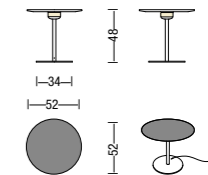

GLT52
Tavolino Glam rotondo 52 cm
Glam round side table 52 cm

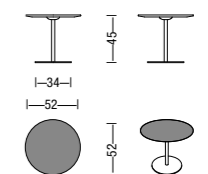

GLT68
Tavolino Glam rotondo 68 cm
Glam round side table 68 cm

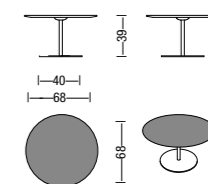

Finiture struttura in metallo
Metal structure finish

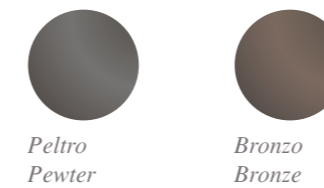

Finiture piani
Top finishes

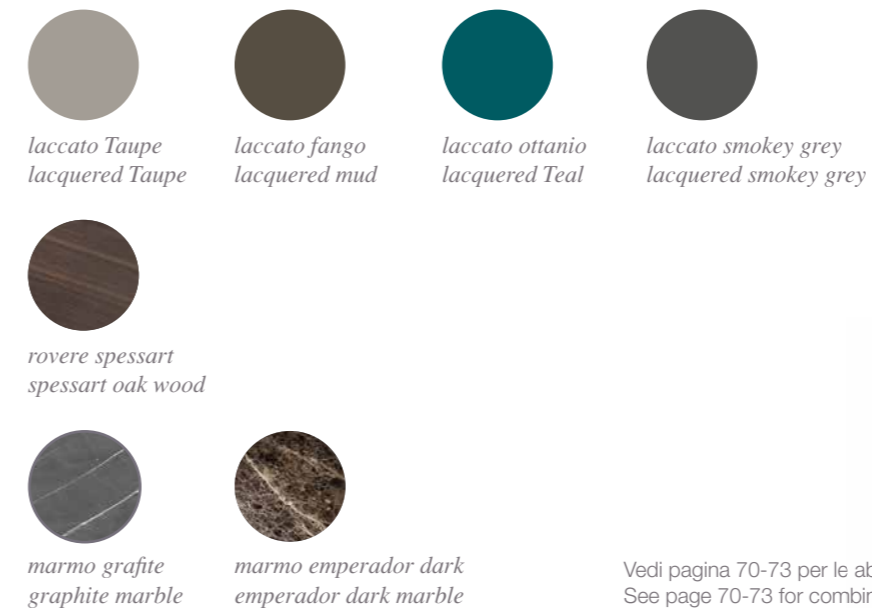

Vedi pagina 70-73 per le abbinare
See page 70-73 for combined colors



Struttura portante: Tubolari e basamento in acciaio, verniciati Peltro. Tubolare superiore rivestito in Nabuk o Tecnonabuk. Rivestimento fisso. Basamento dotato di scivolanti.

Meccanismo: esclusivo meccanismo ART NOVA (design by Arch. Giulio Manzoni) in grado di passare da 38 cm a 72 cm di piano d'appoggio, con un movimento fluido regolabile in qualsiasi posizione. Il movimento è consentito da un sistema meccanico di carrucole e pistone idraulico sincronizzato.

Finiture piani: in MDF rivestiti in cuoio naturale (silver o grafite), o in MDF laccati nei colori: grigio perla, taupe, smokey grey o piombo lucido.

Structure: Tubes and base in steel, with Pewter painted finish. Upper tube covered in Nabuk or Tecnonabuk. Base with slides.

Mechanism: exclusive ART NOVA mechanism ables to move from 38 cm to 72 cm, with a flowing motion adjustable in any position. The synchronized movement is allowed by a mechanical system of pulleys and hydraulic piston.

Top finishes: MDF covered with natural leather (silver o grafite) or MDF lacquered as available colors: pearl grey, taupe, smokey grey or piombo glossy finish.

DY80
Tavolino alzabile 80x80 cm
Liftable table 80x80 cm

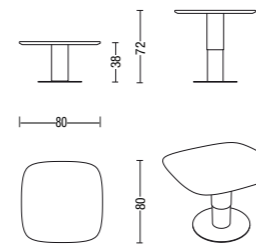

DY110
Tavolino alzabile 110x54 cm
Liftable table 110x54 cm

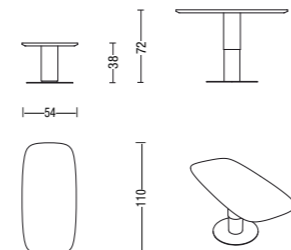

DY130
Tavolino alzabile 130x65 cm
Liftable table 130x65 cm

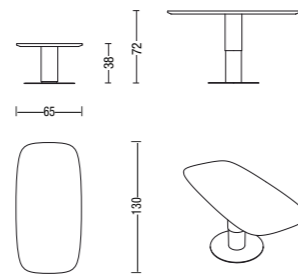

Finiture struttura in metallo
Metal structure finish



Peltro
Pewter

Rivestimenti della struttura in metallo
Metal structure covering



Tecnonabuk 15



Tecnonabuk 44



Tecnonabuk 66



pellami a campionario
leathers in collection

Finiture piani
Top finishes



cuoio silver
leather hide silver



cuoio grafite
leather hide graphite



laccato Taupe
lacquered Taupe



laccato grigio perla
lacquered pearl grey



laccato piombo lucido
glossy lacquered lead



laccato smokey grey
lacquered smokey grey



Vedi pagina 110 per le abbinare
See page 110 for combined colors

Struttura: in metallo pressofuso verniciato Peltro.
Finiture piani: in MDF rivestiti in cuoio naturale o in MDF laccati nei colori in collezione.

Structure: in die-cast metal with Pewter painted finish.
Top finishes: natural leather-covered or lacquered as available colors.

CLT52
Tavolino Cloud rotondo da 52 cm
Cloud round side table 52 cm

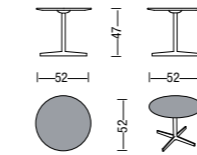

CLT85X68
Tavolino Cloud ovale da 85x68 cm
Cloud oval coffee table 85x68 cm

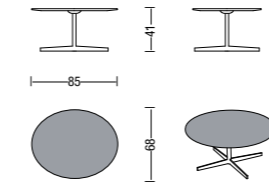

Finiture struttura in metallo
Metal structure finish



Peltro
Pewter

Finiture piani
Top finishes



fango
leather hide
or lacquered

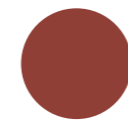

london
leather



grafite
leather hide
or lacquered



taupe
leather hide
or lacquered



silver
leather hide
or lacquered



ottanio
lacquered

Struttura: in metallo verniciato Peltro.
Finiture piani: in MDF rivestiti in cuoio naturale, in MDF laccati nei colori in collezione o in marmo.

Structure: in die-cast metal with Pewter painted nish.
Top nishes: natural leather-covered, lacquered as available colors or marble.

FLT6A
Tavolino esagonale Alto 69x58 cm
Exagonal High side table 69x58 cm

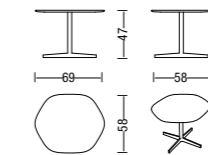

FLT6ALX
Tavolino esagonale Alto 69x58 cm con luce e ricarica USB
Exagonal High side table 69x58 cm with light and USB charging

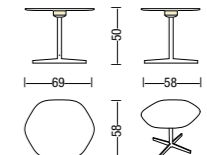

FLT6B
Tavolino esagonale Basso 69x58 cm
Exagonal Low side table 69x58 cm

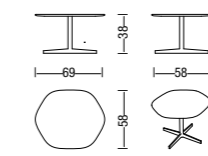

Tavolino abbinabile con FLT160
Side table matchable with FLT160

FLT8
Tavolino ottagonale 92x92 cm
Octagonal coffee table 92x92 cm

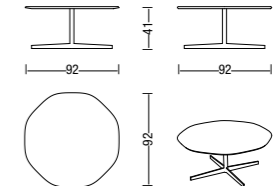

FLTD
Tavolo consolle dining 150x58 cm
Console dining table 150x58 cm

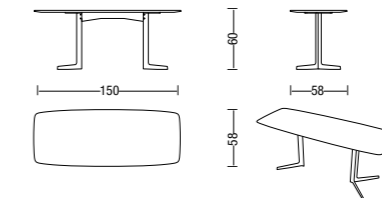

FLT160
Tavolino ottagonale lungo 160x80 cm
Octagonal wide coffee table 160x80 cm

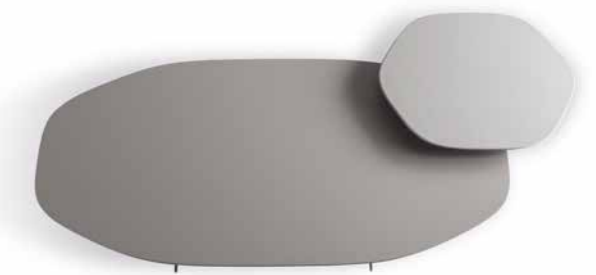
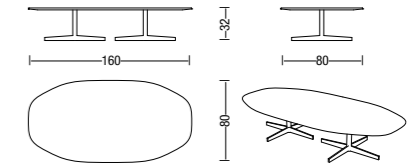

Vedi pagina 98 per le abbinare
See page 98 for combined colors

Struttura portante: in acciaio con inserti in legno.

Preparazione della struttura: in poliuretano espanso stampato a freddo ad alta densità. Sedile in poliuretano a densità differenziata stampato a freddo. Rivestimento della struttura con fibra di poliestere termolegata accoppiata con vellutino.

Sfoderabilità: rivestimento sfoderabile nella versione in tessuto e fisso nella versione in pelle.

Basamento: basamento girevole in legno di frassino disponibile tinto rovere naturale, wengé o smokey grey.

Structure: Steel framework, with wood insert.

Preparation of the seat: entirely moulded with cold-cure polyurethane. Moulded seat cushion with cold-cure polyurethane. Outer covering with a high depth polyester fiber heat-bonded to white technical fiber.

Covers: completely removable in fabric version and fixed in leather version.

Base: ash wood swivel base, stained natural oak, wengé or painted smokey grey.

**Finiture basamento legno
Wood base finishes**



Frassino tinto wengé
Ashwood stained wengé



Frassino tinto rovere
Ashwood stained oak

**Poltrone
Armchairs**

CE76LG
Celine poltrona Low back Girevole
Celine armchair Low back swivel basement

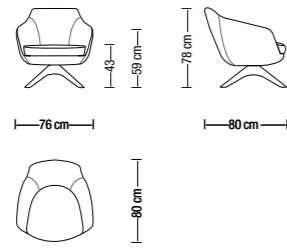

CE76HG
Celine poltrona High back Girevole
Celine armchair High back swivel basement

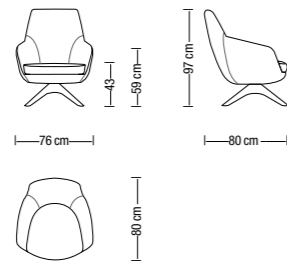

**Poltroncina dining
Little armchair**

CE63
Celine poltroncina dining
Celine little armchair

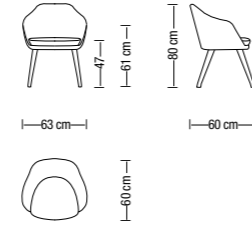

Struttura portante: in legno massello e multistrato con molleggio garantito da cinghie elastiche ad alta componente di caucciù.

Preparazione della struttura: in poliuretano espanso a quote differenziate ad alta densità e resilienza. Rivestimento della struttura con fibra di poliestere termolegata, accoppiata con vellutino.

Cuscini schienale: cuscino di schienale imbottito in piuma d'oca canalizzata certificata "Assopiuma etichetta Oro" con poggiaresi in fiocchi di fibra di poliestere integrato. Cuscini ornamentali in piuma d'oca canalizzata certificata "Assopiuma".

Sfoderabilità: rivestimento sfoderabile nella versione in tessuto, previo smontaggio dello schienale a innesto rapido. Fissa nella versione in pelle. I cuscini di schienale sono completamente sfoderabili.

Basamento: piedi arretrati in ABS o basamento girevole disponibile per Love chair M.

Structure: in solid wood and plywood, with high natural rubber content elastic strap webbing.

Preparation of the seat: in high resilience variable-density polyurethane foam. Outer covering with heat-bonded polyester fiber laminated to white technical fiber.

Backrest cushion: channeled goose down, (Certified Assopiuma, gold label) complete with a lumbar support polyester fiber insert. Ornamental cushion: channeled goose down, certified "Assopiuma".

Covers: completely removable in fabric version, after disassembly of the backrest structure. Fixed in leather version. Backrest cushion covers are completely removable.

Base: half-hidden ABS feet or swivel base, available for Love chair M.

Sono disponibili misure speciali su richiesta. I disegni a catalogo sono da considerarsi suggerimenti di configurazione: schienali e cuscini sono elementi liberamente abbinabili.

Custom-made elements are available on request. Drawings are configuration suggestions: backrests and cushions are freely combinable elements.

**Poltrone
Armchairs**

LVM
Poltrona LoveChair M
Armchair LoveChair M

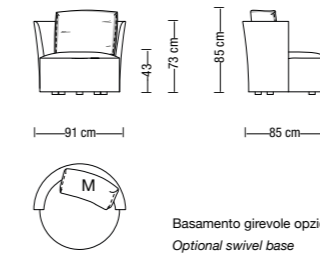

LVL
Poltrona LoveChair L
Armchair LoveChair L

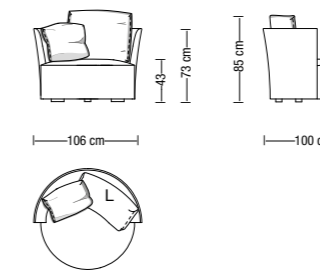

LVXL
Poltrona LoveChair XL
Armchair LoveChair XL

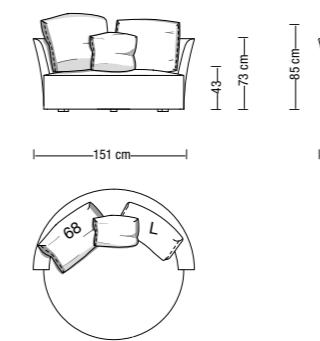

**Pouf
Ottomans**

LV63P
Pouf Love 63 cm
Ottoman Love 63 cm

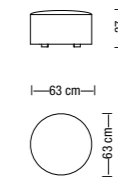

LV83P
Pouf Love 83 cm
Ottoman Love 83 cm

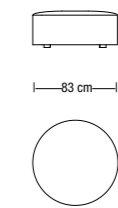

**Cuscini schienale
Backrest cushions**

LVSM
Cuscino schienale M
Backrest cushion M

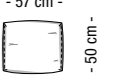

LVSL
Cuscino schienale L
Backrest cushion L

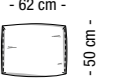

LVC68
Cuscino 68x65 cm piuma
Cushion 68x65 cm feather

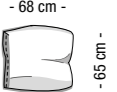

LVC45
Cuscino 45x45 cm piuma
Cushion 45x45 cm feather

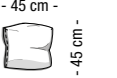

LVP
Poggiaresi
lumbar rest



Struttura portante: telaio composto da legno multistrato e speciale materiale composito brevettato (mix di poliestere e poliuretano).

Preparazione della struttura: in poliuretano espanso ad alta portanza con densità differenziata. Rivestimento della struttura con fibra di poliestere termolegata accoppiata con vellutino.

Sfoderabilità: rivestimento sfoderabile nella versione in tessuto e pelle.

Basamenti: piedi a disegno speciale realizzati in fusione d'alluminio, disponibili nelle versioni: Peltro o Bronzo.

Structure: frame made with plywood and a special patented composite material (mix of polyester and polyurethane).

Preparation of the seat: in high resilience variable-density polyurethane foam. Outer covering with a high depth polyester fiber heat-bonded to white technical fiber.

Covers: completely removable in fabric and leather version.

Base: exclusive design cast aluminum feet, painted Pewter or Bronze.

Finiture struttura in metallo Metal structure finish



*Peltro
Pewter*



*Bronzo
Bronze*

Poltrone Armchairs

HE60SB Poltrona senza braccioli Armchair without armrests

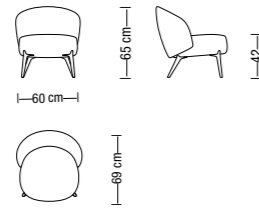

HE68 Poltrona Armchair

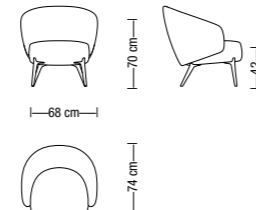

Struttura portante: in acciaio con inserti in legno.

Preparazione della struttura: in poliuretano espanso stampato a freddo ad alta densità. Sedile in poliuretano stampato a freddo. Rivestimento della struttura con fibra di poliestere termolegata accoppiata con vellutino.

Sfoderabilità: rivestimento fisso nella versione in tessuto e nella versione in pelle. I cuscini ornamentali sono completamente sfoderabili.

Basamento: basamento girevole in metallo cromato.

Structure: Steel framework, with wood insert.

Preparation of the seat: entirely moulded with cold-cure polyurethane. Moulded seat cushion with cold-cure polyurethane. Outer covering with a high depth polyester fiber heat-bonded to white technical fiber.

Covers: fixed in fabric version and in leather version. Ornamental cushions cover are completely removable.

Base: swivel metal base polished chrome.

Poltrona e pouf Armchair and ottoman

GM Poltrona Gentleman Gentleman armchair

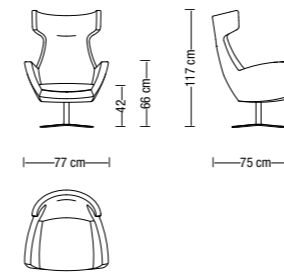

GM50X57P Pouf Gentleman Gentleman ottoman

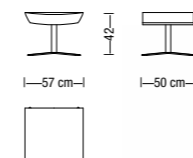

Cuscini Cushions

GMP Poggiareni Lumbar rest



Struttura portante: in acciaio con inserti in legno.

Preparazione della struttura: in poliuretano espanso stampato a freddo ad alta densità. Sedile in poliuretano a densità differenziata stampato a freddo. Rivestimento della struttura con fibra di poliestere termolegata accoppiata con vellutino.

Rivestimento: rivestimento sfoderabile nella versione in tessuto e fisso nella versione in pelle.

Basamento: basamento girevole in legno di frassino disponibile tinto rovere naturale, wengé o smokey grey.

Structure: Steel framework, with wood insert.

Preparation of the seat: entirely moulded with cold-cure polyurethane. Moulded seat cushion with cold-cure polyurethane. Outer covering with a high depth polyester fiber heat-bonded to white technical fiber.

Covers: completely removable in fabric version and fixed in leather version.

Base: ash wood swivel base, stained natural oak wengé or painted smokey grey.

Finiture basamento legno Wood base finishes



*Frassino tinto wengé
Ashwood stained wengé*



*Frassino tinto rovere
Ashwood stained oak*

Poltrona Armchair

TU Poltrona Tulip Tulip Armchair

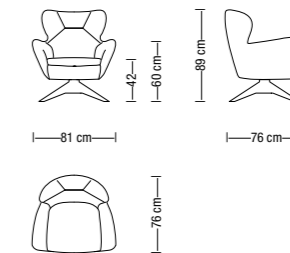

Cuscini Cushions

TUP Poggiareni Lumbar rest

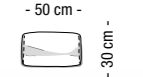

Struttura portante: testata in legno massello, multistrato e OSB. Base letto in legno massello e multistrato, o nella versione con contenitore in nobilitato.

Preparazione della struttura: in poliuretano espanso a quote differenziate ad alta densità e resilienza. Rivestimento della struttura con fibra di poliestere accoppiata con vellutino. Finiture laterali della testata, smontabili, in legno massello.

Base letto: rete in metallo a doghe in legno e traverso di supporto in metallo con piede centrale regolabile. Indy tailor con contenitore: base letto contenitore con rete in metallo a doghe in legno dotata di meccanismo alzarete manuale, con leveraggi in metallo e pistoni a gas.

Sfoderabilità: rivestimento sfoderabile in tessuto e parzialmente sfoderabile in pelle.

Basamento: la testata dispone di piedi nascosti di supporto in ABS. La versione "Indy tailor" con base imbottita o con contenitore ha piedi arretrati in legno massello.

Finiture legno: noce canaletto o rovere coke.

Structure: headboard in plywood and particleboard, bed frame in laminated wood.

Structure preparation: in high resilience variable density polyurethane foam. Outer covering with heat-bonded fiber laminated to technical fiber. Headboard lateral finishing, removable, in solid wood.

Bed base: wood slatted metal base and reinforcing bar with adjustable feet. Indy tailor storage: base with wood slatted metal base, fitted with a manual lift-up mechanism.

Covers: completely removable in fabric version and in leather version.

Base: half-hidden solid wood feet.

Wood finish: canaletto oak or coke oak.

Finiture legno
Wood finishes



Noce canaletto Rovere coke
Canaletto walnut Coke oak wood



IN206T 180-190-200

Letto 206 cm / Base Tailor 180cm
/ Base Tailor 190 cm
/ Base Tailor 200 cm

Bed 206 cm / Tailor base 180 cm
/ Tailor base 190 cm
/ Tailor base 200 cm

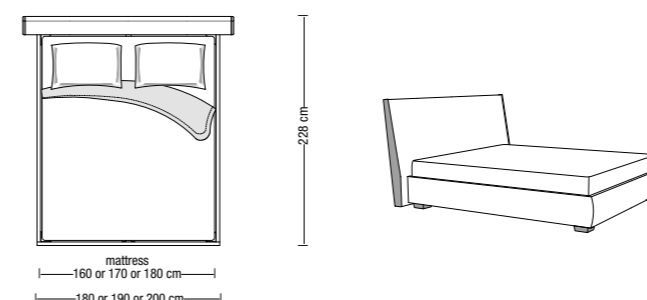
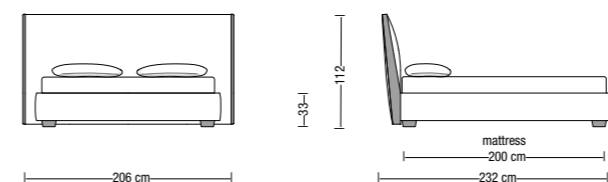

IN304T 190-200

Letto 304 cm / Base Tailor 190 cm
/ Base Tailor 200 cm

Bed 304 cm / Tailor base 190 cm
/ Tailor base 200 cm

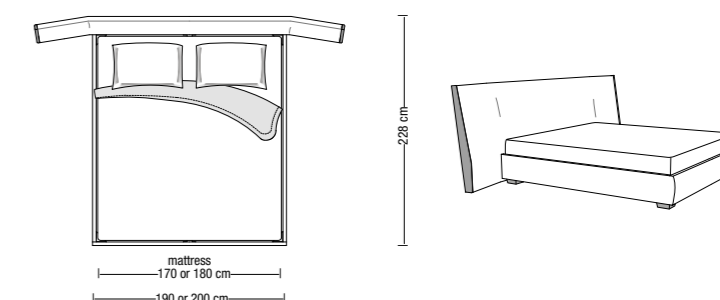
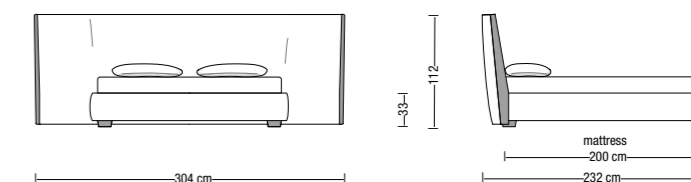

IN206TC 180-190-200

Letto 206 cm / Base contenitore 180 cm
/ Base contenitore 190 cm
/ Base contenitore 200 cm

Bed 206 cm / Storage base 180 cm
/ Storage base 190 cm
/ Storage base 200 cm

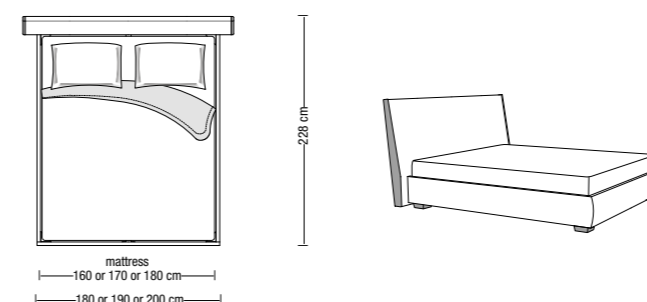
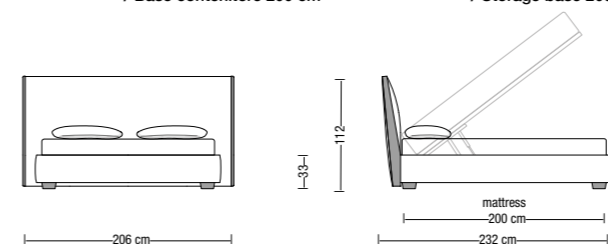

IN304TC 190-200

Letto 304 cm / Base contenitore 190 cm
/ Base contenitore 200 cm

Bed 304 cm / Storage base 190 cm
/ Storage base 200 cm

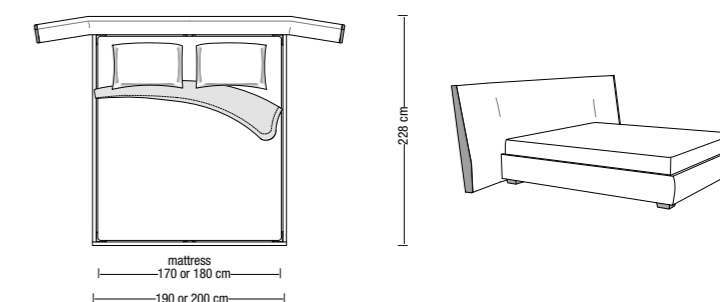
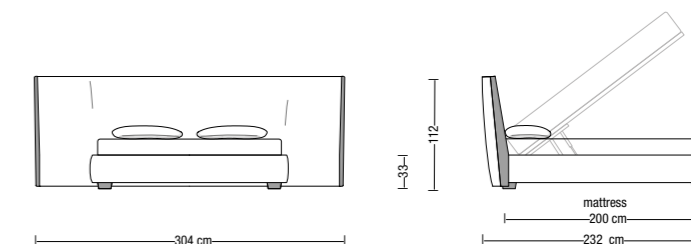

IN206TQ

Letto 206 cm / Base Tailor 174 cm queen size
Bed 206 cm / Tailor base 174 cm queen size

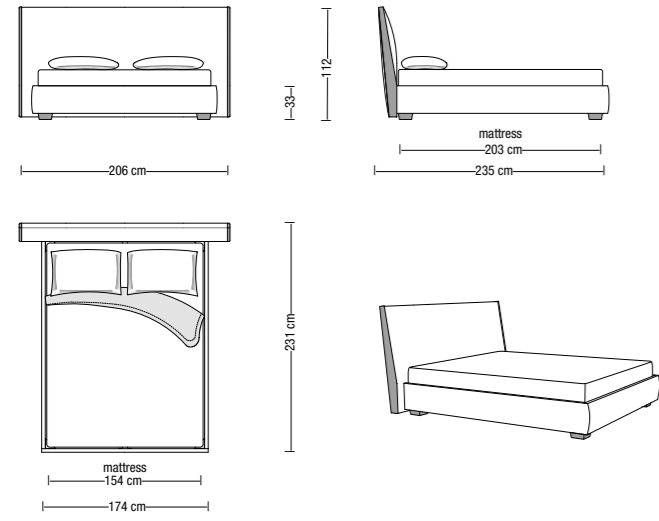

IN206TCQ

Letto 206 cm / Base contenitore 174 cm queen size
Bed 206 cm / Storage base 174 cm queen size

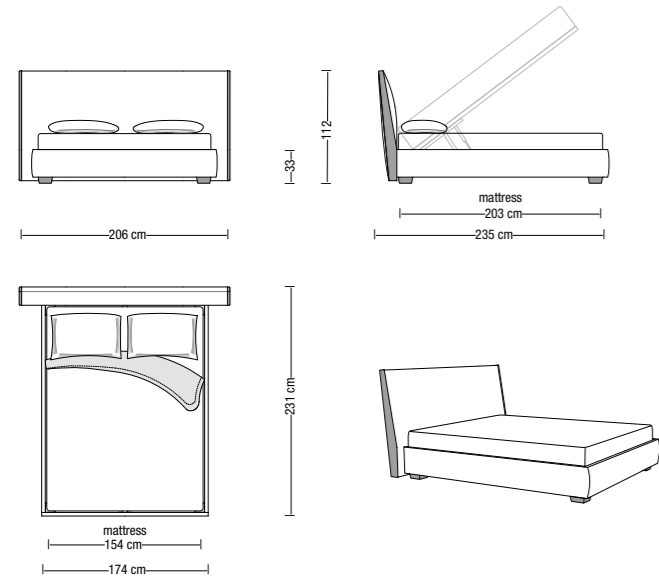

IN226TK

Letto 226 cm / Base Tailor 213 cm king size
Bed 226 cm / Tailor base 213 cm king size

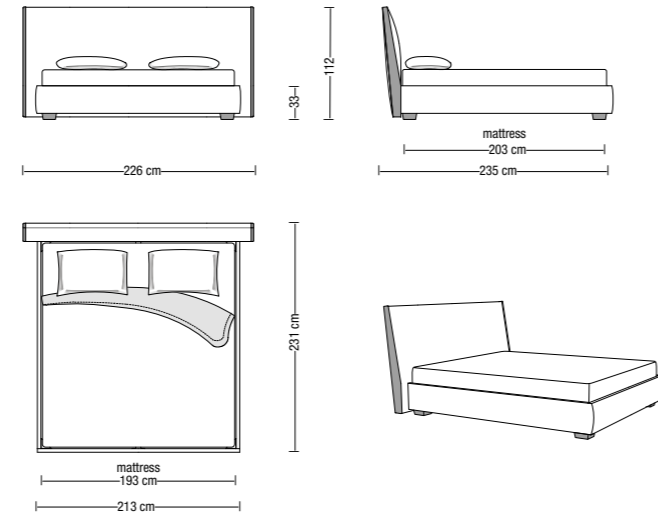

IN226TCK

Letto 226 cm / Base contenitore 213 cm king size
Bed 226 cm / Storage base 213 cm king size

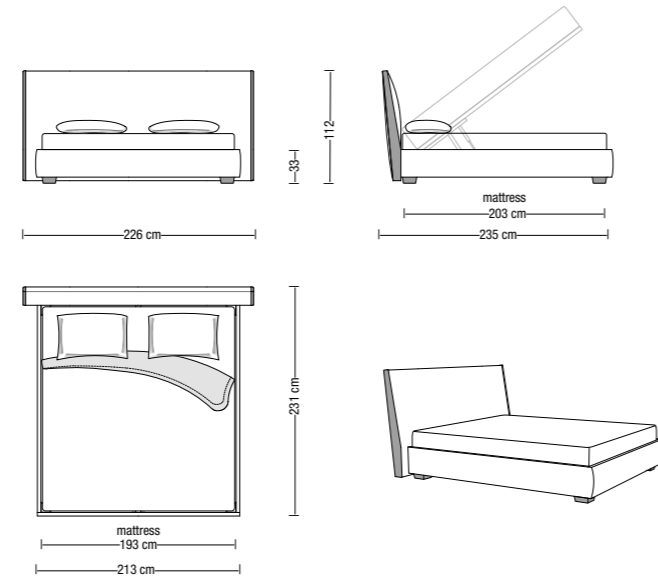

IN317TK

Letto 317 cm / Base Tailor 213 cm king size
Bed 317 cm / Tailor base 213 cm king size

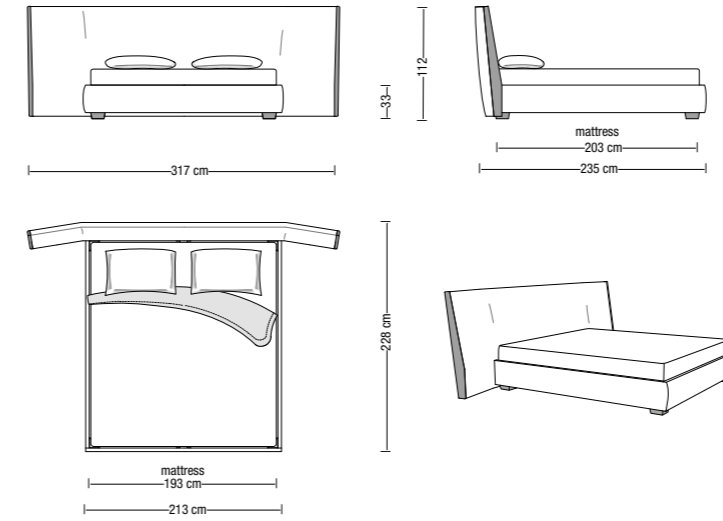

IN317TCK

Letto 317 cm / Base contenitore 213 cm king size
Bed 317 cm / Storage base 213 cm king size

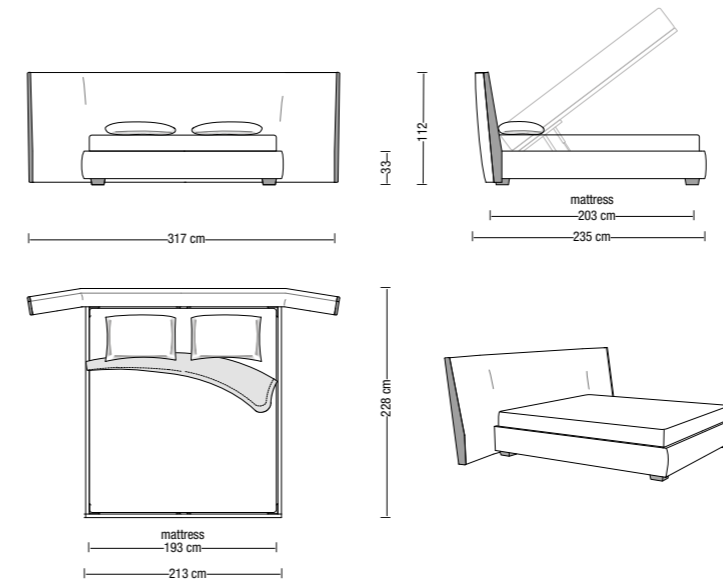

IN140X58P

Panchetta da 140x58 cm
Bench 140x58 cm

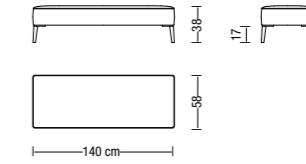

Struttura portante: testata in legno massello, multistrato e OSB. Base letto in legno massello e multistrato.

Preparazione della struttura: in poliuretano espanso a quote differenziate ad alta densità e resilienza. Rivestimento della struttura con fibra di poliestere accoppiata con vellutino. Finiture laterali della testata, smontabili, in legno massello.

Base letto: rete in metallo a doghe in legno e traverso di supporto in metallo con piede centrale regolabile.

Sfoderabilità: rivestimento sfoderabile in tessuto e parzialmente sfoderabile in pelle.

Basamento: la versione a base sospesa è corredata di basamento in legno massello lavorato a controllo numerico. La testata dispone di piedi nascosti di supporto in ABS. La versione con base contenitore ha piedi arretrati in legno massello.

Finiture legno: noce canaletto o rovere coke.

Structure: headboard in plywood, solid wood and OSB. Bed frame in solid wood and plywood.

Structure preparation: in high resilience variable density polyurethane foam. Outer covering with heat-bonded fiber laminated to technical fiber. Headboard lateral finishing, removable, in solid wood.

Bed base: wood slatted metal base and reinforcing bar with adjustable feet.

Covers: completely removable in fabric version and partially in leather version.

Base: the bed base has feet in solid wood shaped with numerical control. The headboard has hidden feet in ABS. The storage base has hidden feet in solid wood.

Wood finish: canaletto oak or coke oak.

Finiture legno
Wood finishes

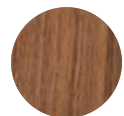

Noce canaletto
Canaletto walnut



Rovere coke
Coke oak wood



IN206W 176-186-196

Letto 206 cm / Base 176 cm
/ Base 186 cm
/ Base 196 cm

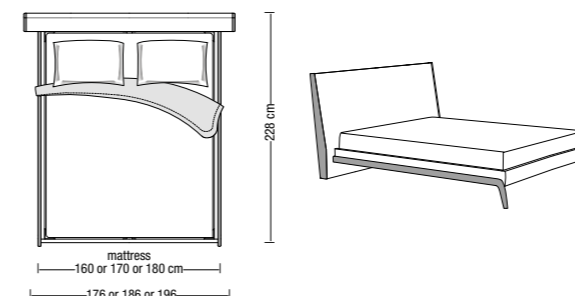
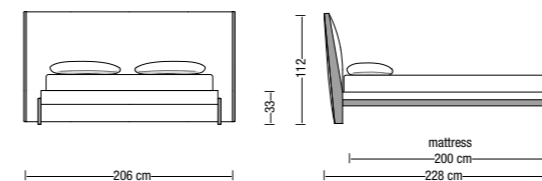

Disponibili anche versioni per materassi king o queen size
Also available king/queen versions

IN304W 186-196

Letto 304 cm / Base 186 cm
/ Base 196 cm

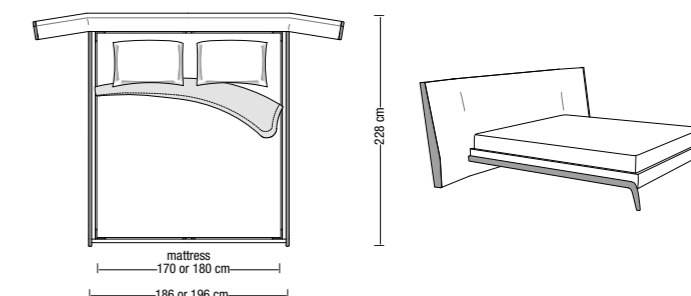
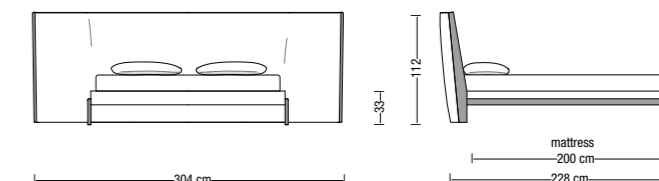

Struttura portante: testata e base letto in legno massello e multistrato.

Preparazione della struttura: in poliuretano espanso a quote differenziate ad alta densità e resilienza. Rivestimento della struttura con fibra di poliestere termolegata, accoppiata con vellutino e fibra di poliestere siliconata ad alto spessore.

Base letto: in legno massello e multistrato con fori per una corretta areazione.

Sfoderabilità: rivestimento sfoderabile nella versione in tessuto e nella versione in pelle.

Basamento: speciali piedi arretrati in ABS con gomma antiscivolo.

Tavolini opzionali: indipendenti e spostabili in acciaio rivestito in pelle o in cuoio ecologico, disponibile in svariate colorazioni, con scivolanti in nylon.

Poggiatesta opzionali: schienalini indipendenti e spostabili in acciaio rivestito in pelle o in cuoio ecologico disponibili nelle colorazioni a campionario.

Structure: headboard and bed frame in solid wood and plywood.

Structure preparation: in high resilience variable-density polyurethane foam. Outer covering with heat-bonded polyester fiber laminated to white technical fiber. The headboard results soft and comfortable for the head.

Bed base: solid wood and plywood shaped and perforated with numerical control machine.

Covers: completely removable in fabric and leather version.

Base: specials half-hidden ABS feet, non-slip rubber.

Optional bedside tables: in steel covered with leather or ecologic leather in many different colors, nylon protective glides.

Optional headrest: movable metal backrest covered with leather or ecologic leather as available colors.

IB223X230

Island bed 223x230 cm

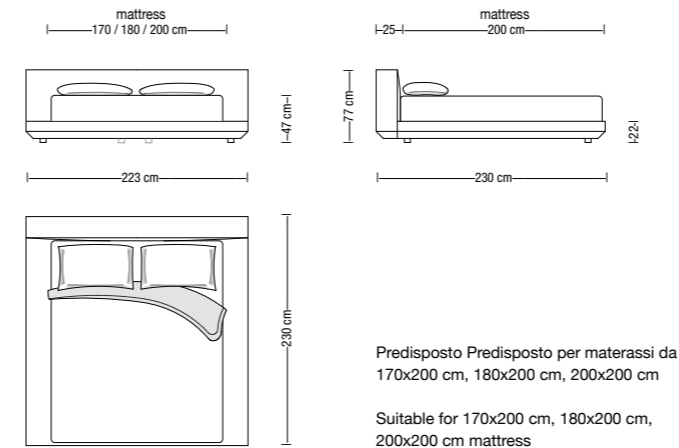

IB143X230

Island single bed 143x230 cm

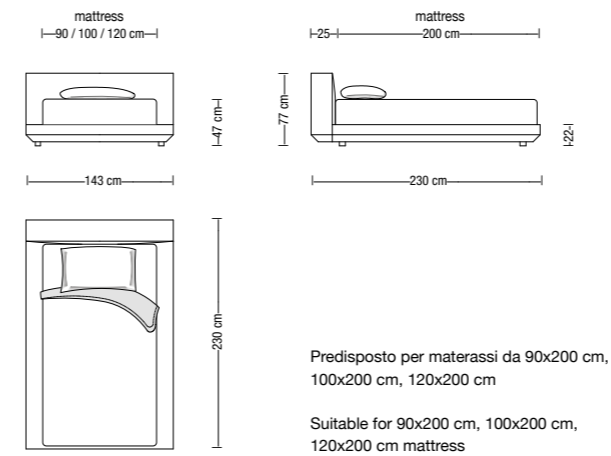

IBT58

Tavolino da 58 cm in metallo e pelle
Leather and steel 58 cm bedside table

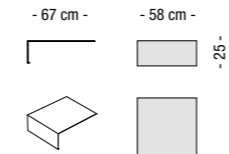

SUP

Schienalino di supporto in metallo e pelle
Leather and steel backrest

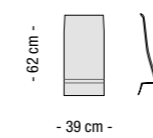

IB186X218S

Slim island bed 186x218 cm

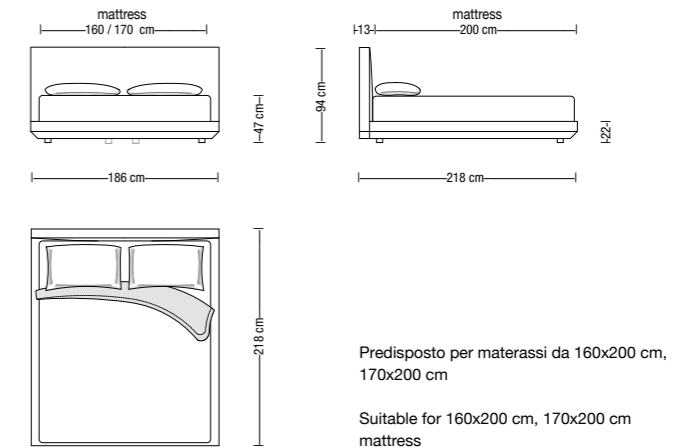

IB106X218S

Slim island single bed 106x218 cm

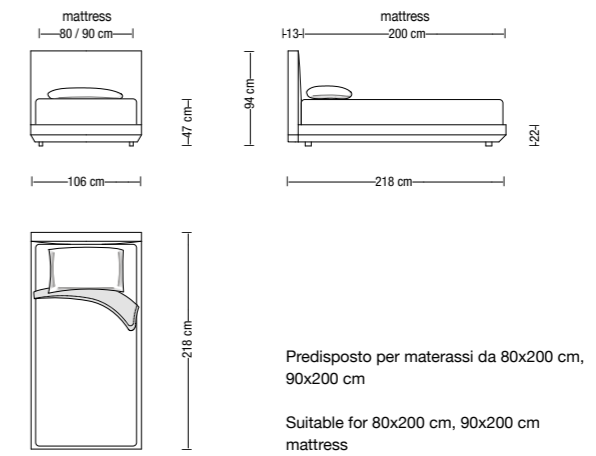

Sono disponibili misure speciali su richiesta.
Custom-made elements are available on request.

Struttura portante: testata in legno multistrato e agglomerato, base letto in legno multistrato, nella versione con contenitore in nobilitato.

Preparazione della struttura: in poliuretano espanso a quote differenziate ad alta densità e resilienza. Rivestimento della struttura con fibra di poliestere termolegata, accoppiata con vellutino. Testata imbottita con fibra di poliestere siliconata per un appoggio soffice e confortevole per la testa.

Base letto: rete in metallo a doghe in legno. In alternativa: base letto contenitore con rete in metallo a doghe in legno dotata di meccanismo alzarete manuale, con leveraggi in metallo e pistoni a gas.

Sfoderabilità: rivestimento sfoderabile sia nella versione in tessuto che nella versione in pelle.

Basamento: piedi arretrati in legno massello.

Structure: headboard in plywood and particleboard, bed frame in plywood, storage base in laminate wood.

Structure preparation: in high resilience variable-density polyurethane foam. Outer covering with heat-bonded silicon fiber laminated to white technical fiber. The headboard results soft and comfortable for the head.

Bed base: wood slatted metal base, in alternative storage base with wood slatted metal base, fitted with a manual lift-up mechanism.

Covers: completely removable in fabric version and in leather version.

Base: half-hidden solid wood feet.



Sono disponibili misure speciali su richiesta.
Custom-made elements are available on request.

BO 214-204-194-174

Letto BOLD
BOLD bed

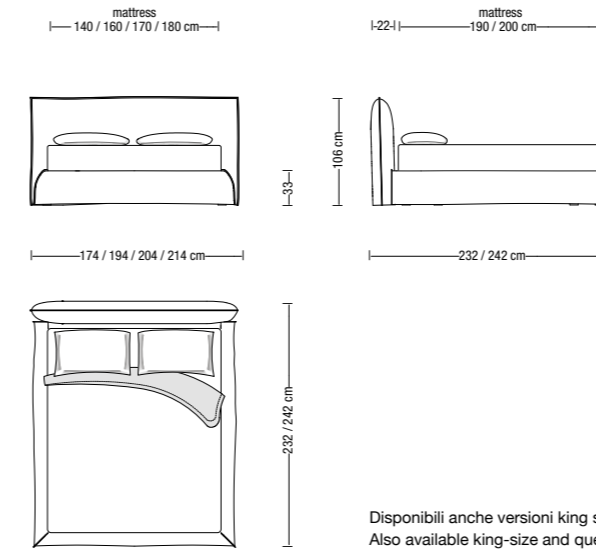

Disponibili anche versioni king size / queen size
Also available king-size and queen-size versions

BO 214-204-194-174 C

Letto BOLD con base contenitore
BOLD bed with storage base

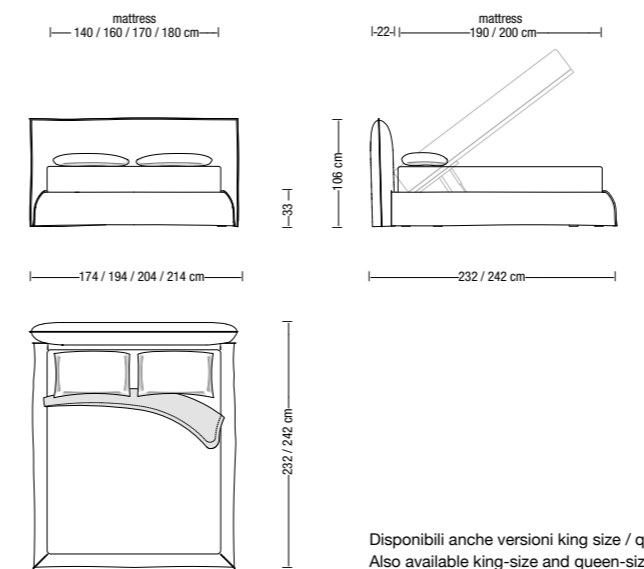

Disponibili anche versioni king size / queen size
Also available king-size and queen-size versions

BO 154-134-124

Letto BOLD singolo
BOLD single bed

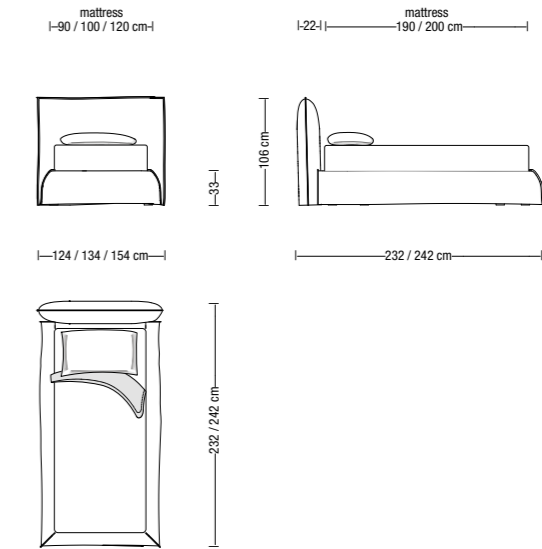

BO 154-134-124 C

Letto BOLD singolo con contenitore
BOLD single bed with storage base

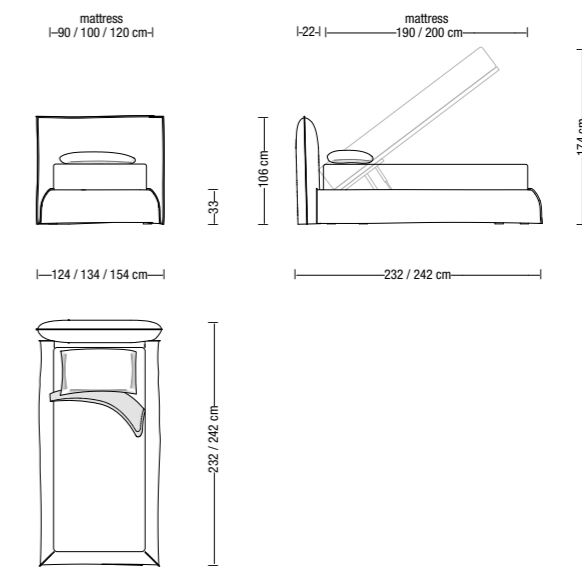

Disponibili anche versioni king size / queen size
Also available king-size and queen-size versions

concept, **Studio Mussi**

photo, **Lorenzo Carone, Marco Mussi**

virtual photo, **Officinemimesi**
Verabilia
Imergo

Thanks to

Turati T4

Fazzini Home

Bilumen

Yesterday antichità

Mobilform

Penta Light

© ART NOVA srl 12.2019

Stampando su carta, la tonalità dei colori dei vari materiali non può essere riprodotta fedelmente, pertanto deve considerarsi indicativa e non potrà costituire motivo di contestazione o di restituzione del prodotto.

Shades of fabric colours shown as samples may vary due to the fact that they appear on paper, it is for this reason that all colours are considered indicative and the company will not be liable for differences should they arise in the final product.

ART NOVA srl • VIA MAURI 4, 21010 BESNATE (VA) ITALIA
T +39 0331 273232 F +39 0331 273233 INFO@ARTNOVA.IT WWW.ARTNOVA.IT